

R E P O R T R E S U M E S

ED 014 418

SE 001 652

ILLUSTRATIONS OF RADIOISOTOPES--DEFINITIONS AND APPLICATIONS.
ATOMIC ENERGY COMMISSION, OAK RIDGE, TENN.

PUB DATE 65

EDRS PRICE MF-\$0.75 HC-\$6.68 165P.

DESCRIPTORS- *ILLUSTRATIONS, *INSTRUCTIONAL MATERIALS,
*RADIOISOTOPES, *SECONDARY SCHOOL SCIENCE, *SCIENCE
MATERIALS, *TRANSPARENCIES, AUDIOVISUAL AIDS, AGRICULTURE,
BIOLOGY, CHEMISTRY, INDUSTRY, PHYSICAL SCIENCES, PHYSICS,
TECHNOLOGY, ATOMIC ENERGY COMMISSION, OAK RIDGE, TENNESSEE,

THIS PUBLICATION IS COMPOSED OF OVER 150 PAGES OF BLACK AND WHITE ILLUSTRATIONS DEALING WITH RADIOISOTOPES AND THEIR USES. THESE ILLUSTRATIONS CONSIST OF CHARTS, GRAPHS, AND PICTORIAL REPRESENTATIONS WHICH COULD BE PREPARED AS HANDOUTS, TRANSPARENCIES FOR OVERHEAD PROJECTION, OR WHICH COULD BE USED IN A NUMBER OF OTHER WAYS FOR PRESENTING SUCH TOPICS AS (1) DEFINITIONS OF RADIOISOTOPES, (2) ISOTOPE PRODUCTION AND AVAILABILITY, (3) ISOTOPE CHARACTERISTICS, AND (4) ISOTOPE APPLICATIONS. THE APPLICATIONS SECTION COMPRISES ABOUT THREE-FOURTHS OF THE DOCUMENT AND INCLUDES APPLICATIONS IN--(1) BIOLOGICAL AND MEDICAL RESEARCH, DIAGNOSIS, AND THERAPY, (2) AGRICULTURE, (3) THE PHYSICAL SCIENCES, AND (4) INDUSTRY. THIS DOCUMENT IS ALSO AVAILABLE AT NO COST FROM THE U.S. ATOMIC ENERGY COMMISSION, DIVISION OF TECHNICAL INFORMATION EXTENSION, EDUCATIONAL MATERIALS SECTION, P. O. BOX 62, OAK RIDGE, TENNESSEE 37831. (DS)

U.S. DEPARTMENT OF HEALTH, EDUCATION & WELFARE
OFFICE OF EDUCATION

THIS DOCUMENT HAS BEEN REPRODUCED EXACTLY AS RECEIVED FROM THE
PERSON OR ORGANIZATION ORIGINATING IT. POINTS OF VIEW OR OPINIONS
STATED DO NOT NECESSARILY REPRESENT OFFICIAL OFFICE OF EDUCATION
POSITION OR POLICY.

Illustrations of
**RADIO-
ISOTOPES**

*Definitions
and
Applications*

*United States
Atomic Energy
Commission
Division of
Technical
Information*

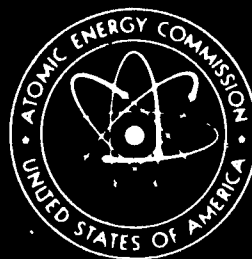

ED014418

SE 001 652

Illustrations of RADIOISOTOPES/ contents

I.	DEFINITIONS OF RADIOISOTOPES	1
II.	PRODUCTION AND AVAILABILITY	7
III.	ISOTOPE CHARACTERISTICS	19
IV.	ISOTOPE APPLICATIONS	35
V.	ISOTOPE APPLICATIONS IN BIOLOGY AND MEDICINE, RESEARCH . . .	44
VI.	ISOTOPE APPLICATIONS IN BIOLOGY AND MEDICINE, DIAGNOSIS . .	63
VII.	ISOTOPE APPLICATIONS IN BIOLOGY AND MEDICINE, THERAPY . . .	75
VIII.	ISOTOPE APPLICATIONS IN AGRICULTURE	90
IX.	ISOTOPE APPLICATIONS IN PHYSICAL SCIENCES	101
X.	ISOTOPE APPLICATIONS IN INDUSTRY	123

**ISOTOPE ILLUSTRATIONS
DEFINITIONS OF RADIOISOTOPES**

MECHANISMS OF RADIATION

● PROTON ○ NEUTRON

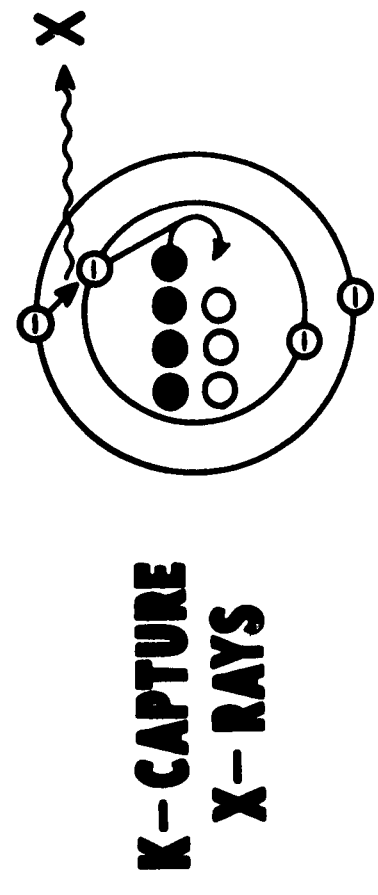
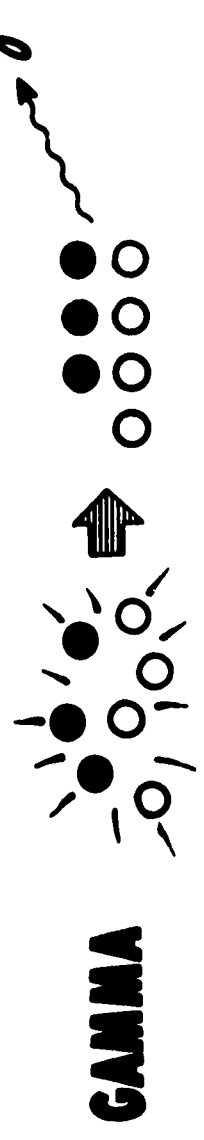
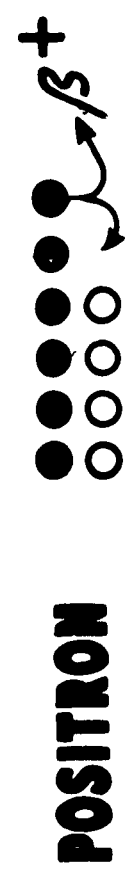
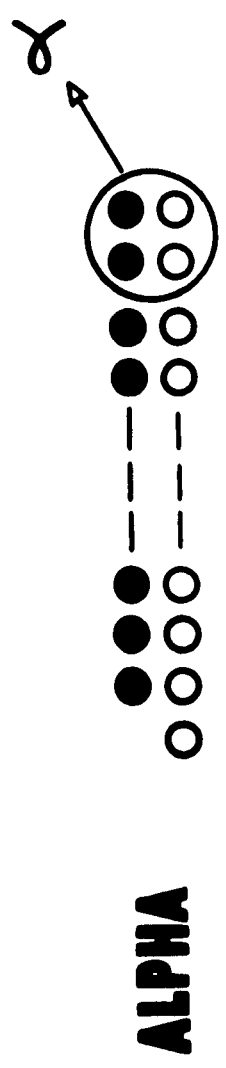

ISOTOPES
(NUCLEAR SPECIES OR NUCLIDES)

TOTAL NUMBER IDENTIFIED ~ 2000

STABLE

NUMBER IDENTIFIED ~ 280
**NUMBER AVAILABLE IN
CONCENTRATED FORM ~ 250**

RADIOACTIVE

NUMBER IDENTIFIED ~ 1700
NUMBER OCCURRING IN NATURE ~ 50
**NUMBER DISTRIBUTED FROM REACTORS
AND CYCLOTRONS ~ 100**

USAEC-ID-324A

STABLE AND RADIOACTIVE NUCLEI

● PROTON ○ NEUTRON

ALL OTHERS UNSTABLE

ISOTOPE

STABLE GROUP

MASS NO.

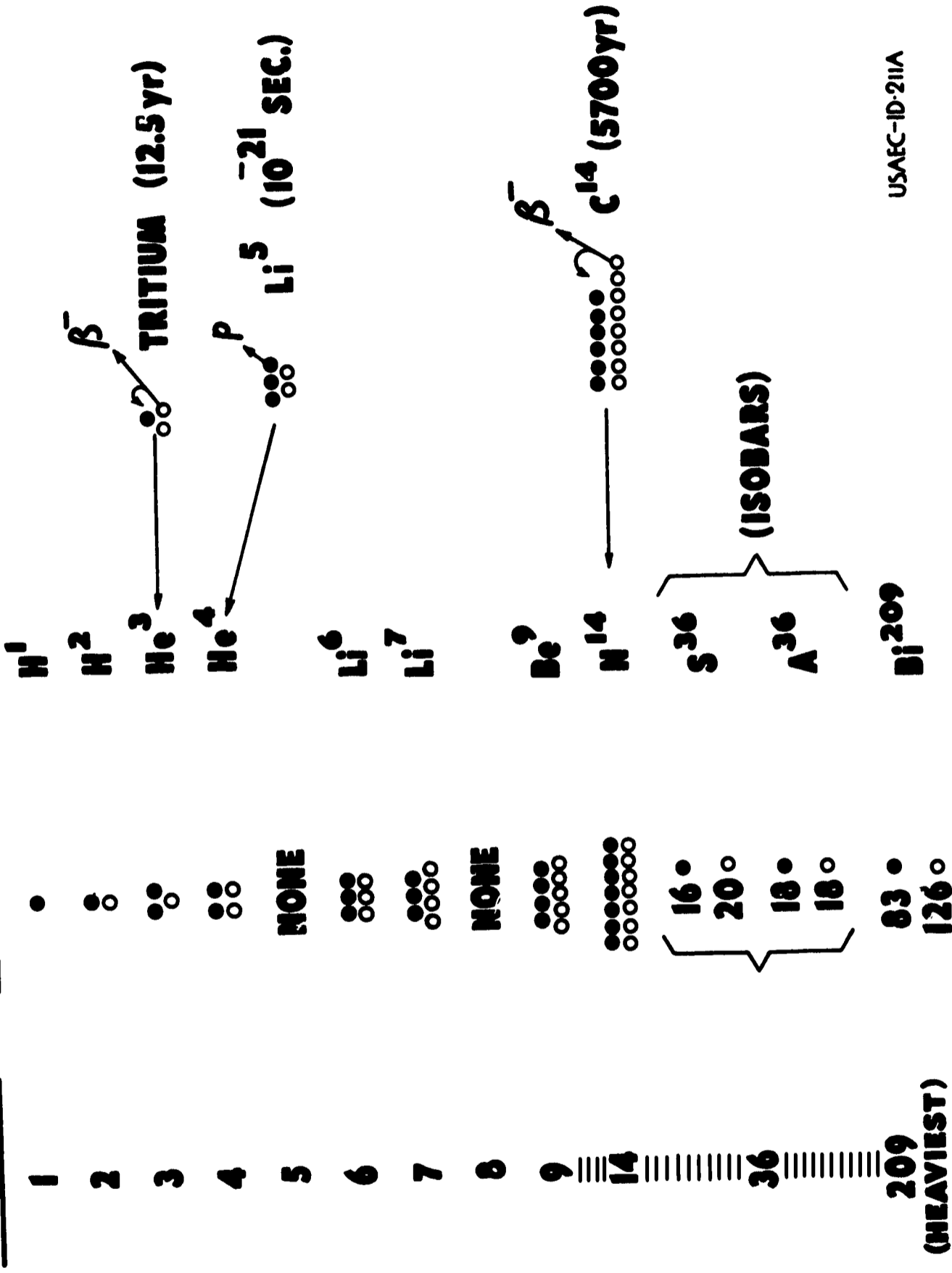

USAEC-ID-211A

WHAT ARE ISOTOPES

ISOTOPES ARE ATOMS OF AN ELEMENT
DISTINGUISHABLE BY THEIR WEIGHT

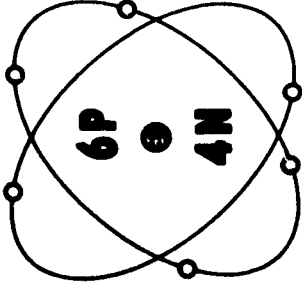
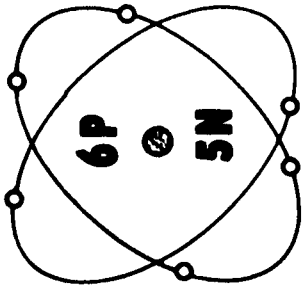
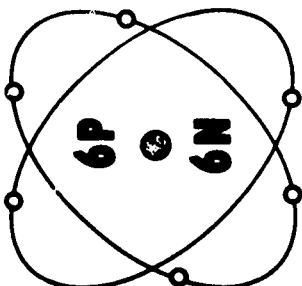
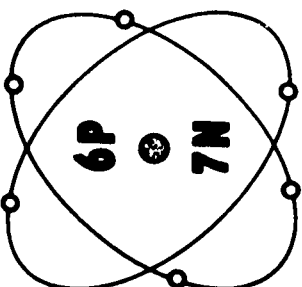
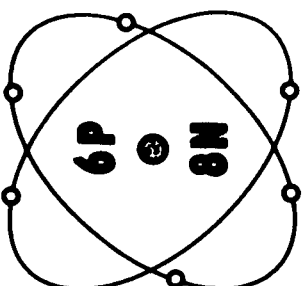
CARBON 10		CARBON 11		CARBON 12		CARBON 13		CARBON 14		MAN-MADE <hr/> RADIOACTIVE
				OCCURS IN NATURE <hr/> STABLE	OCCURS IN NATURE <hr/> STABLE	OCCURS IN NATURE <hr/> STABLE	MAN-MADE <hr/> RADIOACTIVE			

FAMILY of ATOMS

HYDROGEN ATOMS CAN
HAVE SEVERAL FORMS

THESE ARE
ISOTOPES

NATURAL OCCURRING

NATURAL OCCURRING

MAN-MADE

All Hydrogen Atoms Have One Proton

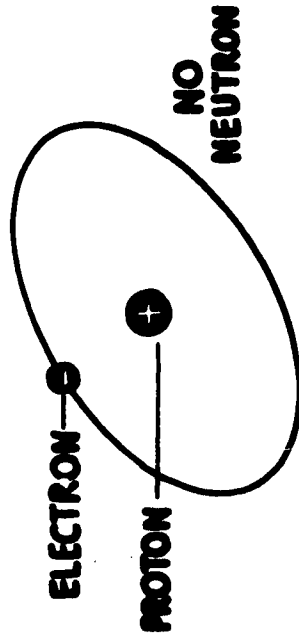

HYDROGEN 1
STABLE

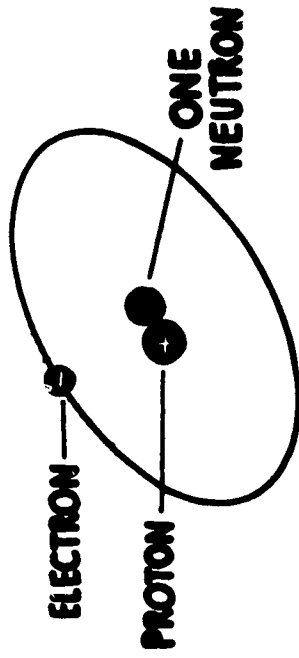

HYDROGEN 2
STABLE

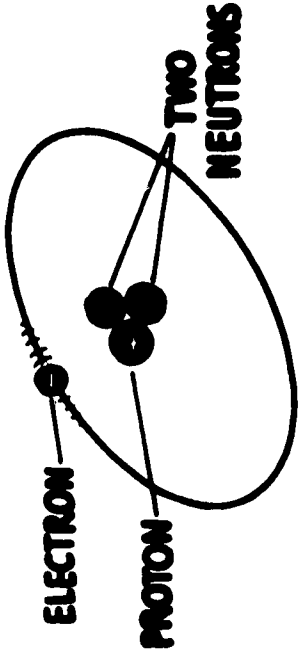

HYDROGEN 3
RADIOACTIVE

USAEC-ID-233A

**ILLUSTRATIONS OF ISOTOPE PRODUCTION
AND AVAILABILITY**

PILE PRODUCTION OF RADIOISOTOPES

NEUTRON CAPTURE

(n, γ) REACTION

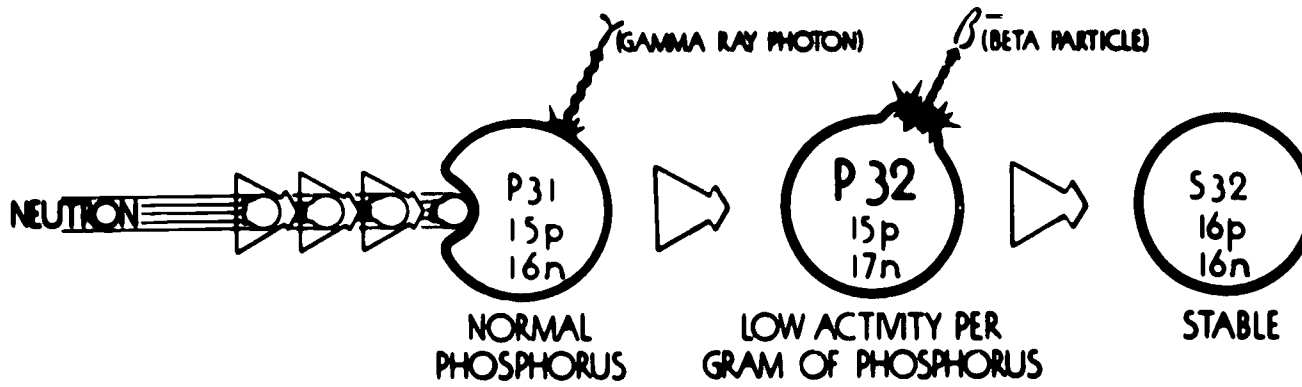
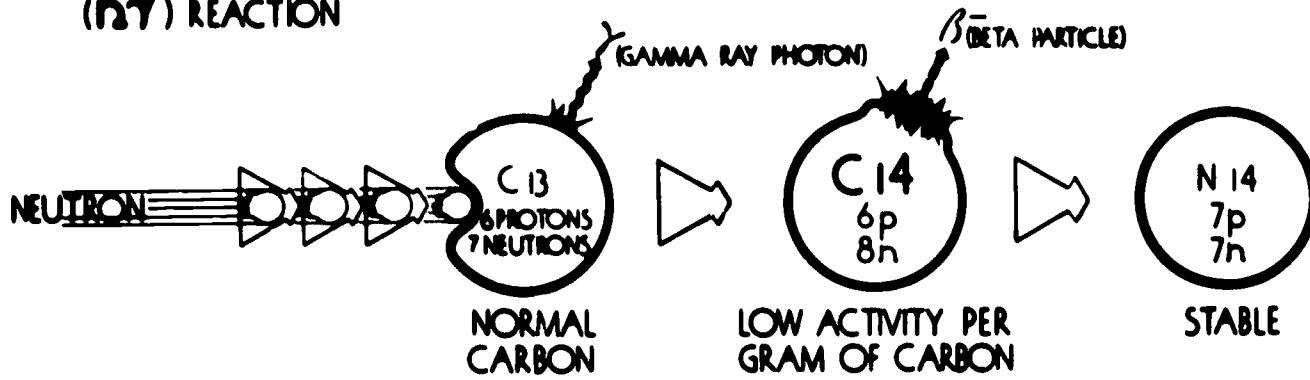

TRANSMUTATION

(n, p) REACTION

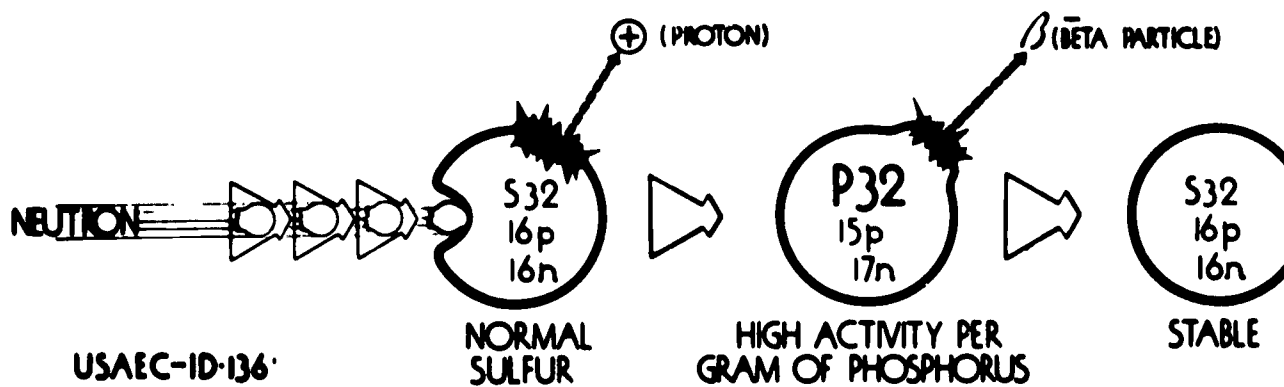
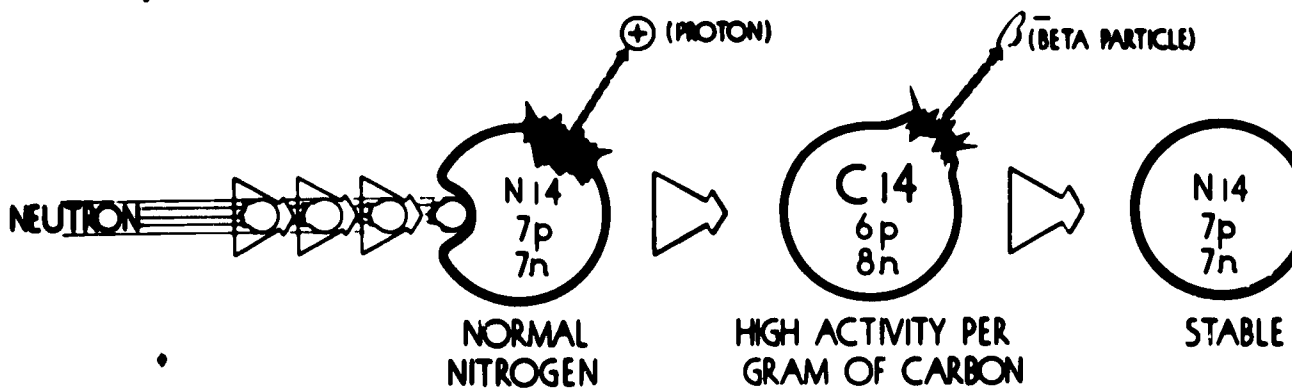

USAEC-ID-136

URANIUM FISSION AND BETA CHAIN DECAY

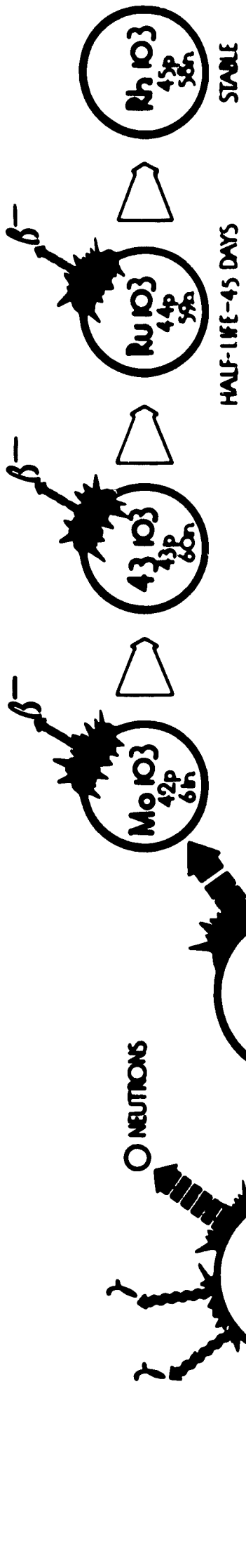

MASS 103 FISSION CHAIN

MASS 131 FISSION CHAIN

"RADIOIODINE 131 - A PRODUCT OF THIS CHAIN"

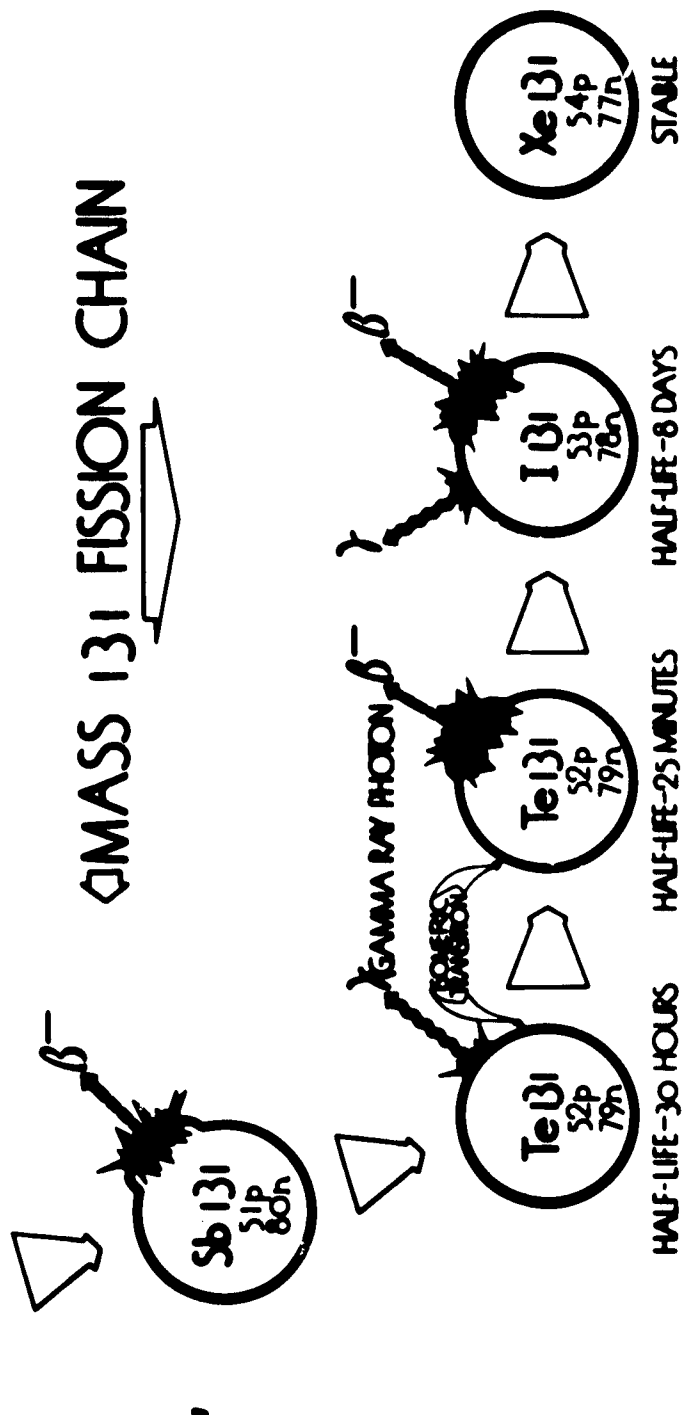

USAEC-ID-137

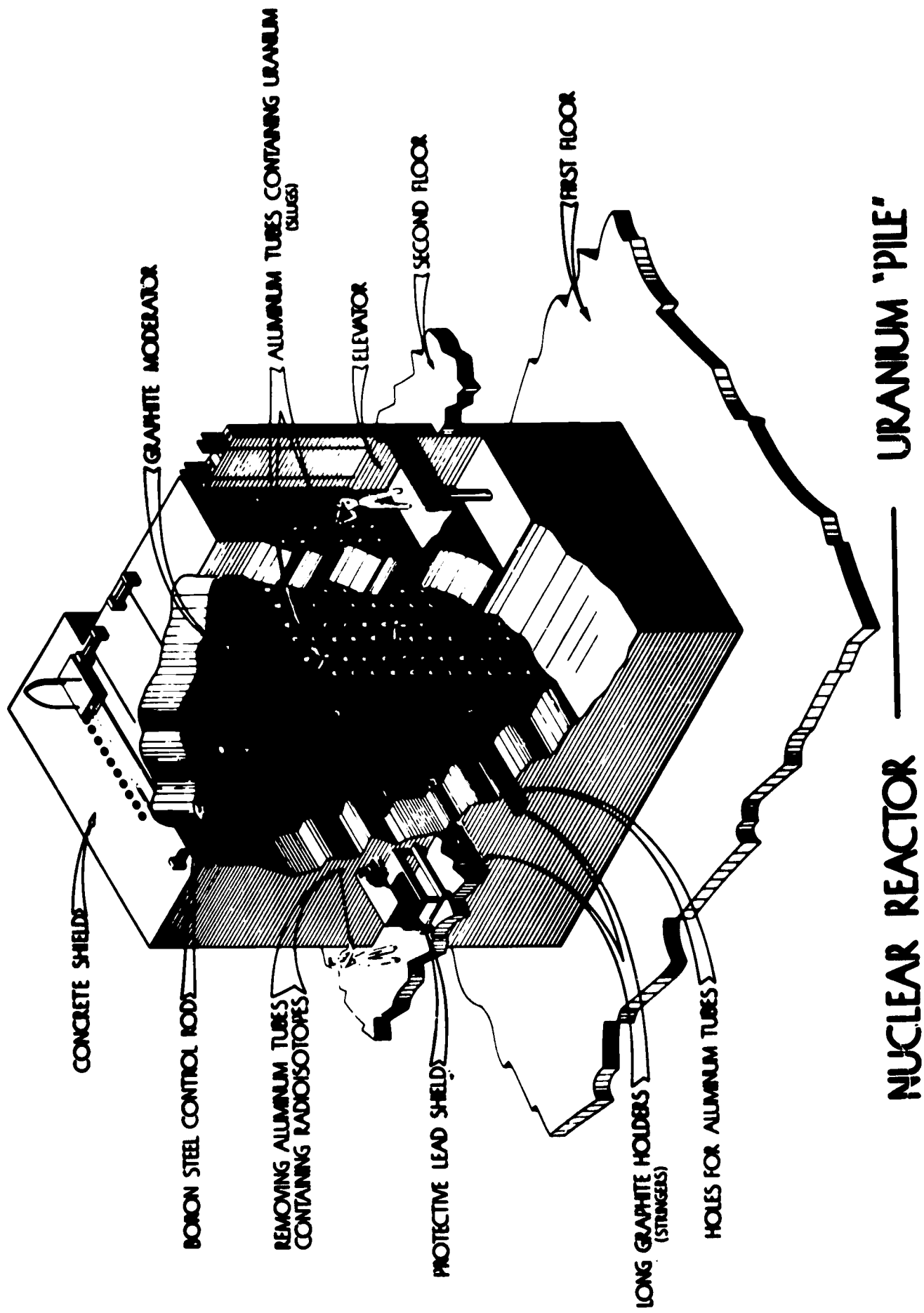

USAEC-ID-08

CHARACTERISTICS OF OAK RIDGE GRAPHITE REACTOR

TEMPERATURE

AVERAGE GRAPHITE TEMPERATURE ----- 130° C
VOLUME OF COOLING AIR ----- 100,000 cfm

THERMAL NEUTRON FLUX

MAXIMUM ----- 1.2×10^{12} n/cm²/sec.
AVERAGE ----- 5×10^{11} n/cm²/sec.

POWER LEVEL

DESIGN LEVEL ----- 1000 kw
OPERATING LEVEL ----- 3800 kw

USAEC-ID-50A

NUCLEAR REACTOR-PRODUCED PURE BETA RAY EMITTING RADIOISOTOPES

USEFUL IN CLINICAL STUDIES

<u>ELEMENT</u>	<u>ISOTOPE</u>	<u>HALF-LIFE</u>	<u>MAXIMUM ENERGY OF RADIATION</u>
HYDROGEN	H-3	12.5 YEARS	0.018 MEV.
CARBON	C-14	5570 YEARS	0.155
PHOSPHORUS	P-32	14.3 DAYS	1.701
SULFUR	S-35	87.1 DAYS	0.166
CALCIUM	Ca-45	165 DAYS	0.254
STRONTIUM *YTTTRIUM	Sr-90 Y-90	28 YEARS 2.54 DAYS	0.61 2.10

*RADIOACTIVE DAUGHTER

USAEC-D-83A

NUCLEAR REACTOR-PRODUCED BETA AND GAMMA RAY EMITTING RADIOISOTOPES

USEFUL IN CLINICAL STUDIES

<u>ELEMENT</u>	<u>ISOTOPE</u>	<u>HALF-LIFE</u>	<u>MAXIMUM ENERGY OF RADIATION</u>	
			<u>BETA</u>	<u>GAMMA</u>
SODIUM	Na-24	15.1 HOURS	1.39 MEV	1.37, 2.75 MEV
POTASSIUM	K-42	12.5 HOURS	2.04, 3.58	1.51
IRON	Fe-55	2.94 YEARS		K X RAY 0.006
IRON	Fe-59	44.3 DAYS	0.27, 0.46	1.10, 1.30
COBALT	Co-60	5.2 YEARS	0.31	1.17, 1.33
IODINE	I-131	8 DAYS	0.33, 0.61	0.060, 0.284, 0.364, 0.637, 0.722
GOLD	Au-198	2.70 DAYS	0.970,	0.411, 0.66, 1.09

USAEC-ID-84A

USEFUL GAMMA RAY EMITTING ISOTOPES

ISOTOPE HALF-LIFE GAMMA RAY ENERGIES - Mev APPROX. SPEC. ACT. #

HIGH ENERGY (OVER 1 Mev)

Co 60	5.3 y	1.17, 1.33	20 c/g
Ag 110	270 d	10 γ 's: 0.676 TO 1.516 0.885(81%), 1.369(33%)	0.65
Eu 152, 154	13, 16 y	~ 0.3, ~ 1.2	?
Ta 182	117 d	33 γ 's: 0.0462 TO 1.237 0.66, 0.885, 0.9 MOST INTENSE	7

MEDIUM ENERGY (0.5 TO 1 Mev)

*Cs 137	37 y	0.662 (2.6m Ba137)	20
*Ce 144	275 d	0.13 (abundant)	(^{137}Ba SO ₄ , d=3.5)
Pr 144 (DAUGHTER)	17.5 m	2.2 } < 10% 1.5 } 0.7 }	100
Ir 192	70 d	12 γ 's: 0.137 TO 0.651	115

LOW ENERGY (< 0.5 Mev)

Se 75	127 d	10 γ 's: 0.067 TO 0.405	0.15
Tm 170	127 d	0.004,	?
W 185	73.2 d	0.134	0.2
Hg 203	43.5 d	0.206	0.2

* REACTOR NEUTRON FLUX = 7×10^{12} n/cm²/sec

* FISSION PRODUCT

USAEC-10-119A

REACTOR IRRADIATION FACILITIES FOR RADIOISOTOPE PRODUCTION

<u>REACTOR</u>	<u>LOCATION</u>	<u>APPROX. FLUX</u>	<u>SAMPLE SIZE</u>	<u>REMARKS</u>
GRAPHITE REACTOR	OAK RIDGE NAT'L LABORATORY	$1 \times 10^{11} - 7 \times 10^{11}$	$3/4"$ DIA. x $2-7/8"$ - $10"$ $3-1/2" \times 3-1/2" \times 10"$ - SI	CHIEF SOURCE OF AEC - SUPPLIED RADIOISOTOPES
BROOKHAVEN REACTOR	BROOKHAVEN NAT'L LABORATORY	$10^{11} - 4 \times 10^{12}$	$3/4"$ DIA. x $2-1/8"$ - $10"$ $12" \times 12" \times 24"$ - SI	IRRADIATION FACILITIES CAN BE COOLED - AIR, WATER, LIQUID NITROGEN
LOW INTENSITY TEST REACTOR-LITR	OAK RIDGE NAT'L LABORATORY	10^{13}	$3/8"$ DIA. x $1-3/4"$ - $10"$	SUPPLEMENTS GRAPHITE REACTOR WHERE HIGHER FLUX REQUIRED
MATERIALS TESTING REACTOR-MTR	NAT'L REACTOR TESTING STATION, IDAHO	5×10^{13}	DEPENDS ON AVAILABLE "RABBIT" OR HOLE	PRINCIPALLY FOR PRODUCTION OF LONG-LIVED MATERIALS
ARGONNE RESEARCH REACTOR-CP-5	ARGONNE NAT'L LABORATORY	5×10^{12}	_____	AVAILABLE PRIMARILY TO PARTICIPATING UNIV'S.

IU - IRRADIATED UNIT
SI - SERVICE IRRADIATION

USAEC-10-151A

PRODUCTION OF RADIOISOTOPES

NEUTRON CAPTURE (n,γ) REACTION

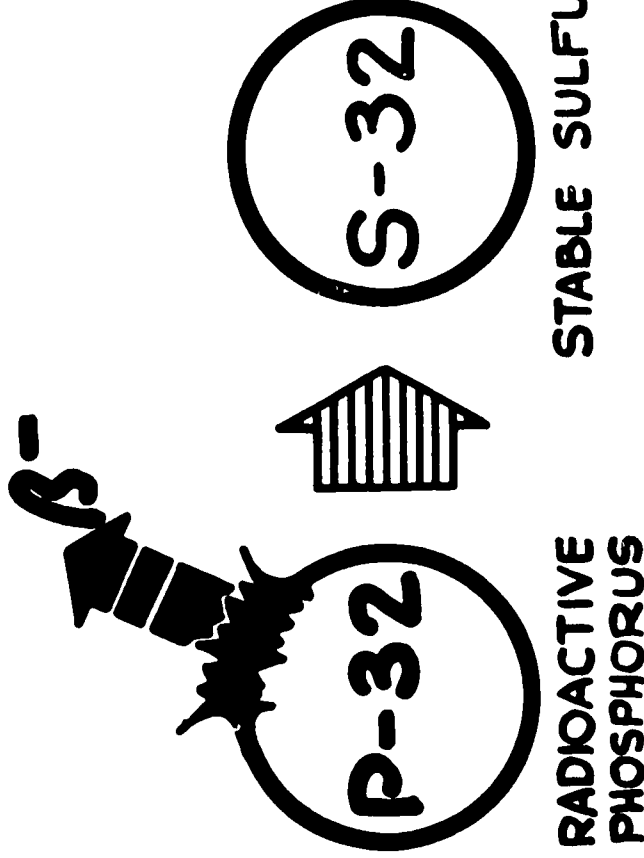
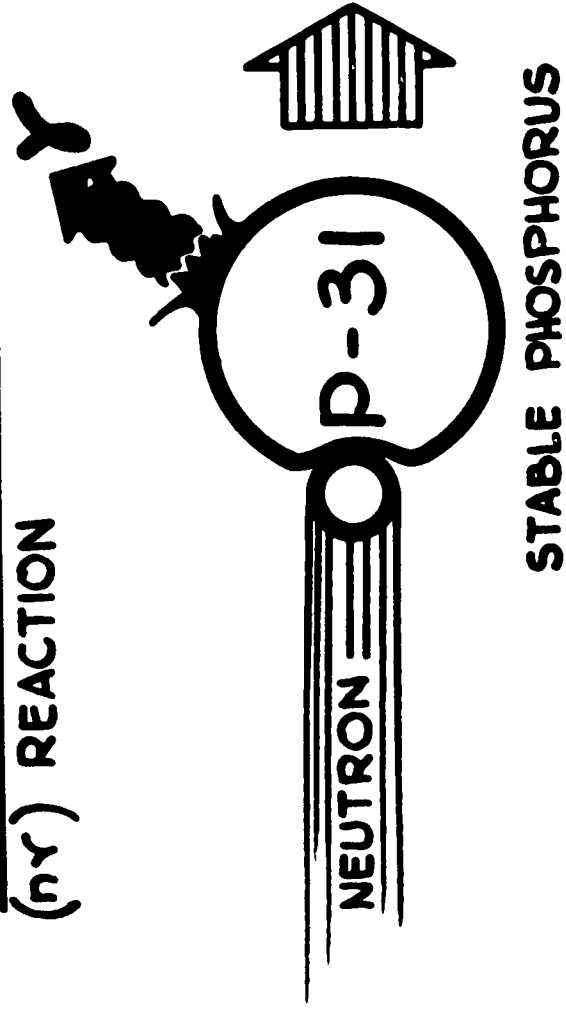

TRANSMUTATION (n,p) REACTION

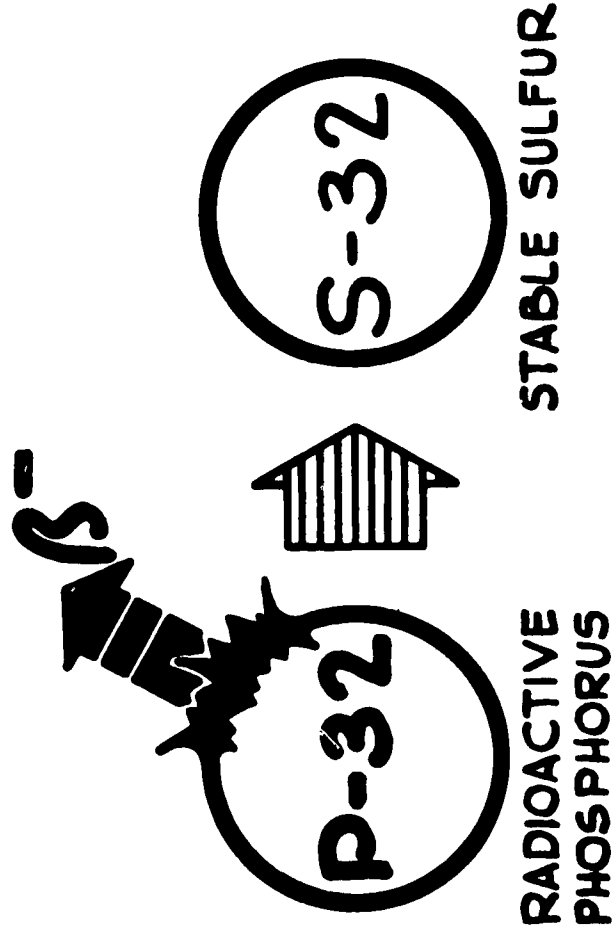
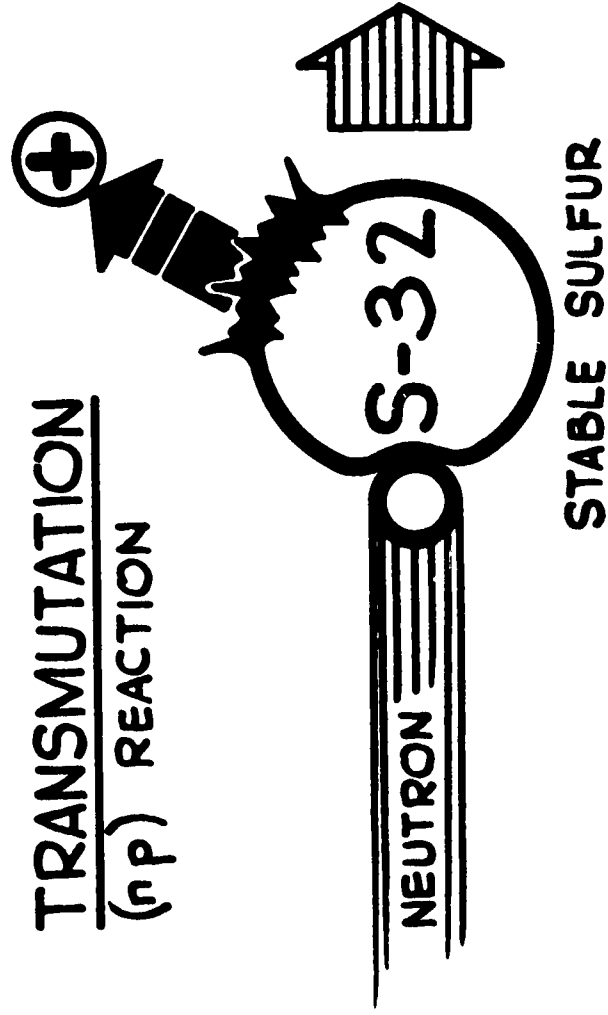

USAEC - ID-292A

Uranium Fission Process

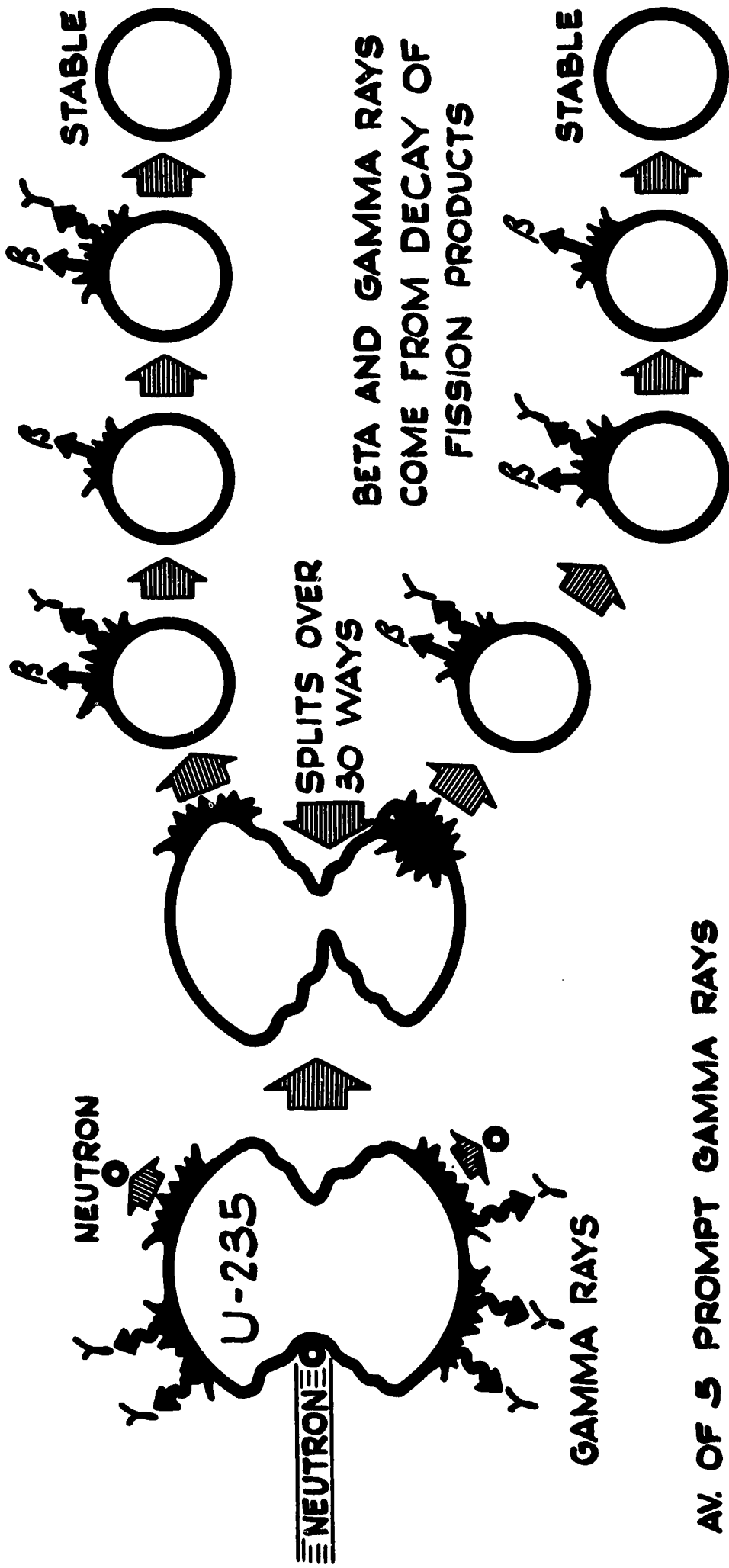

BETA AND GAMMA RAYS
COME FROM DECAY OF
FISSION PRODUCTS

AV. OF 5 PROMPT GAMMA RAYS

AV. OF 2.5 NEUTRONS
(99% PROMPT, 1% DELAYED)

- . FISSION PRODUCTS TOTAL ABOUT 200 RADIOACTIVE SPECIES.
- . ATOMIC NUMBERS 30 TO 64
- . MASSES 72 TO 161
- . (Zn 72 TO Gd 161)

USAEC-ID-322A

ILLUSTRATIONS OF ISOTOPE CHARACTERISTICS

THE MEANING OF HALF-LIFE

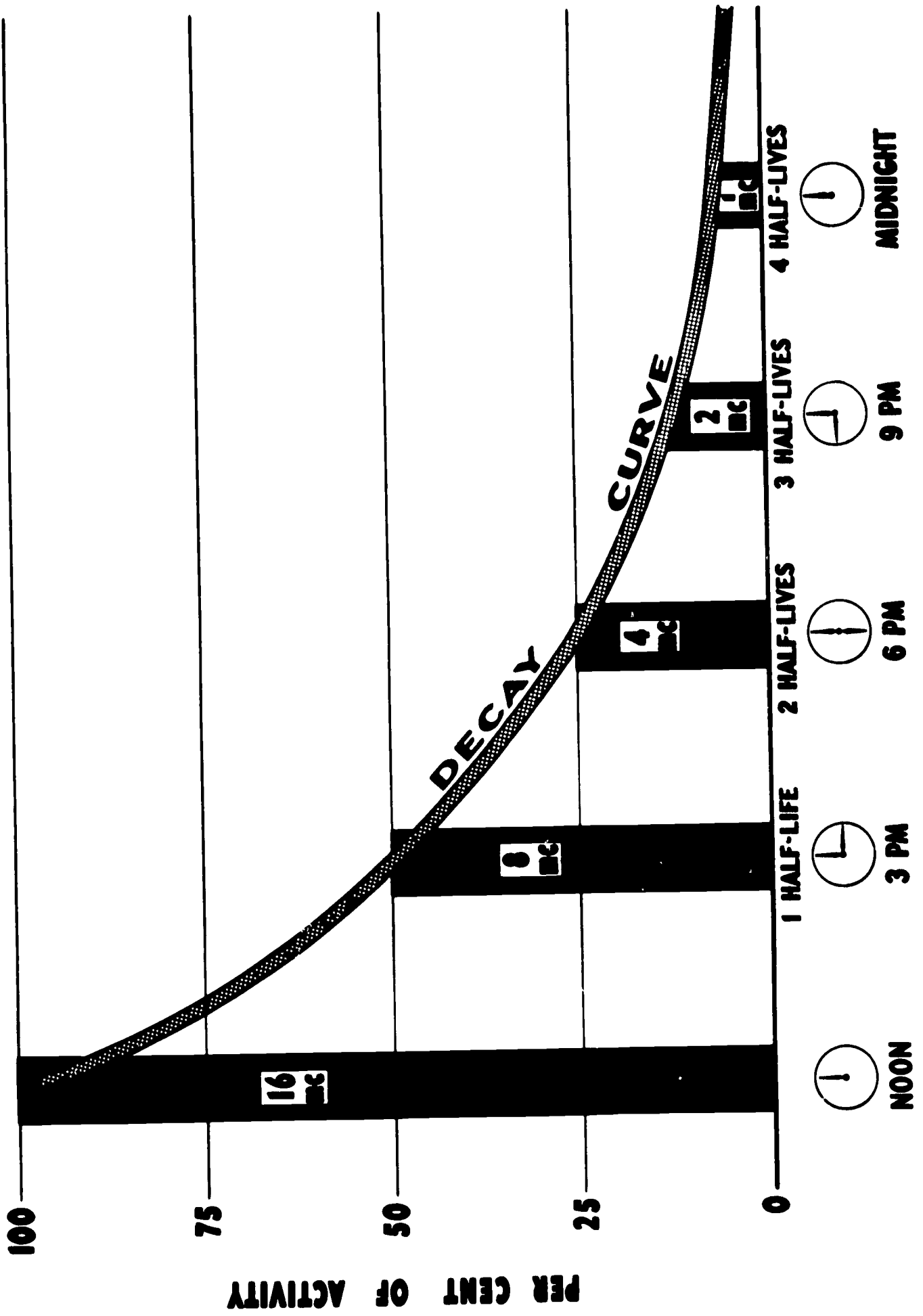

USAEC-ID-359

PROPERTIES OF RADIOACTIVE COBALT

PHYSICAL:

METALLIC — MAGNETIC — NON-CORROSIVE
EASILY MACHINED — HIGH SPECIFIC GRAVITY (~ 8.8)

RADIOACTIVE:

LONG HALF-LIFE (5.2 YR) — WEAK BETA RAY (0.3 MEV)
MONO-ENERGETIC GAMMA RAYS (1.16 AND 1.31 MEV)

AVAILABILITY:

LARGE QUANTITIES AT LOW COST
WIDE RANGE OF ACTIVITIES PER GRAM

EFFECTS OF TOTAL BODY ACUTE RADIATION

ACUTE DOSE

PROBABLE EFFECT

0 - 25 r

NO OBVIOUS INJURY

25 - 50 r

**POSSIBLE BLOOD CHANGES
BUT NO SERIOUS INJURY**

100 - 200 r

INJURY, POSSIBLE DISABILITY

200 - 400 r

**INJURY AND CERTAIN DISABILITY,
DEATH POSSIBLE**

400 - r

FATAL TO 50 %

600 OR MORE

FATAL

MAXIMUM PERMISSIBLE TISSUE DOSE "REPS" PER WEEK

**IN THE BASAL LAYER
OF THE EPIDERMIS**

<u>TYPE OF RADIATION</u>	<u>AT ANY POINT WITHIN BODY</u>	<u>RBE*</u>	<u>EXPOSURE OF ENTIRE BODY</u>	<u>EXPOSURE OF HANDS ONLY</u>
X-RAYS & GAMMA RAYS	0.3	1	0.5	1.5
BETA RAYS	0.3	1	0.5	1.5
PROTONS	0.03	10	0.03	0.15
ALPHA RAYS	0.015	20	0.025	0.075
FAST NEUTRONS	0.03	10	0.05	0.15
THERMAL NEUTRONS	0.06	5	0.1	0.3

*** RBE - RELATIVE BIOLOGICAL EFFECTIVENESS**



**COMPARATIVE GAMMA RAY OUTPUT
FROM
ONE CURIE SOURCES*
(ASSUMING NO SELF-ABSORPTION)**

<u>ISOTOPE</u>	<u>HALF-LIFE</u>	<u>APPROX. r/hr/1m</u>
Au 198	2.7d	0.22
I-131	8.0d	0.24
Cs 137	37y	0.36
Ta 182	117d	0.61
Ra 226 (0.5mm Pt filter)	1620y	0.84
Co 60	5.2y	1.30

***1 CURIE = 37 BILLION DISINTEGRATIONS/SEC**

USAEC-ID-64A

APPROXIMATE GAMMA RAY OUTPUT AND SOURCE VOLUME

(ASSUMING NO SELF-ABSORPTION)

COBALT 60

<u>CURIES</u>	<u>VOLUME</u>	<u>r/min./50 cm</u>	<u>r/min./1m</u>
	SPEC. ACT. 5C/g	SPEC. ACT. 25C/g	
500	11 cm ³	2.2 cm ³	11
1000	22	4.4	22
1500	33	6.6	33

CESIUM 137

<u>CURIES</u>	<u>VOLUME</u>	<u>r/min./50 cm</u>	<u>r/min./1m</u>
	DENSITY (Cs ₂ SO ₄) = 3.5		
1000	13.5 cm ³	17	4
5000	67.5	85	21
10000	135	170	42

USAEC-D-65A



RADIOACTIVITY OF CARBON-14

CARBON-14

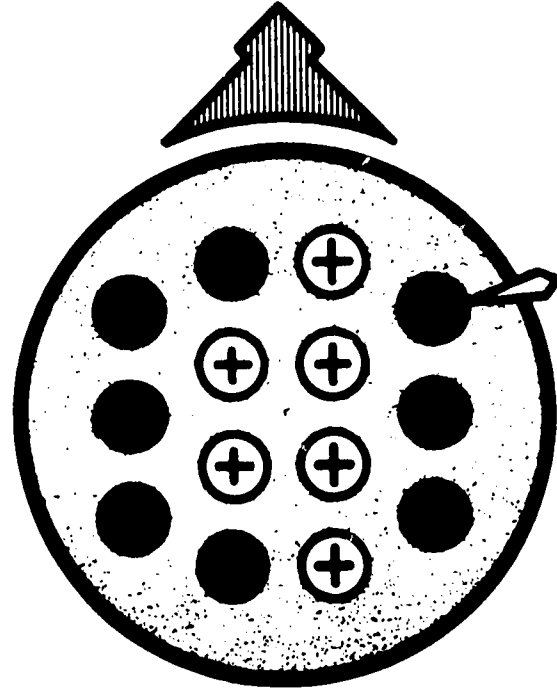

CARBON-14

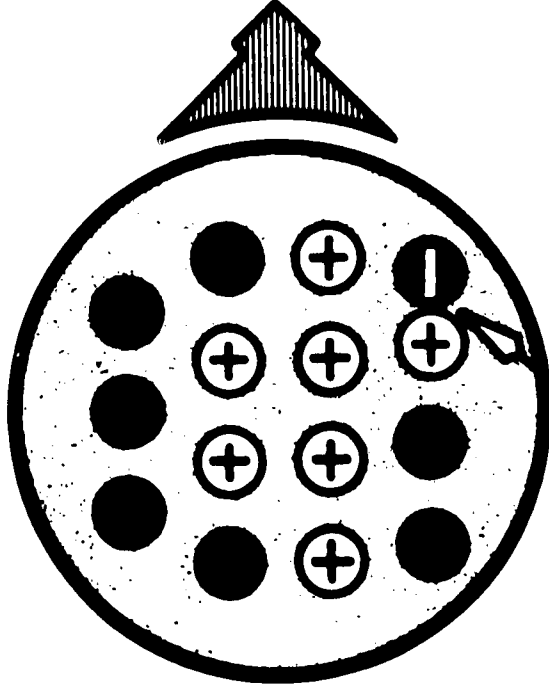

NITROGEN-14

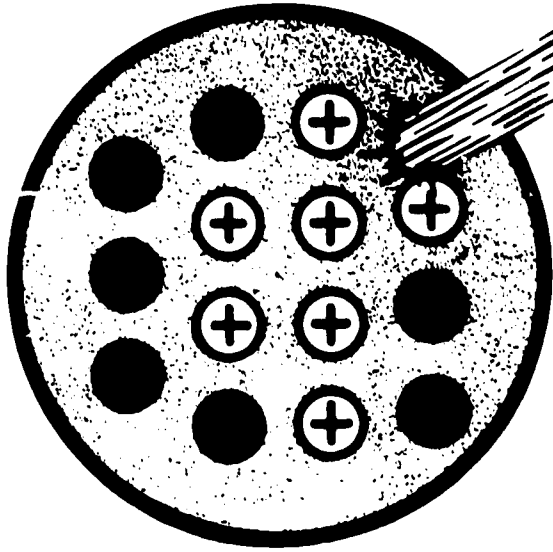

ONE NEUTRON CHANGES TO
A PROTON AND AN ELECTRON

ELECTRON (BETA RAY)
EJECTED

⊕ PROTON

● NEUTRON

⊖ ELECTRON

CARBON-14 — PURE BETA-RAY EMITTER

HALF-LIFE — 5740 YEARS

USAEC-ID-105A

ELECTRICAL PROPERTIES OF RADIATIONS

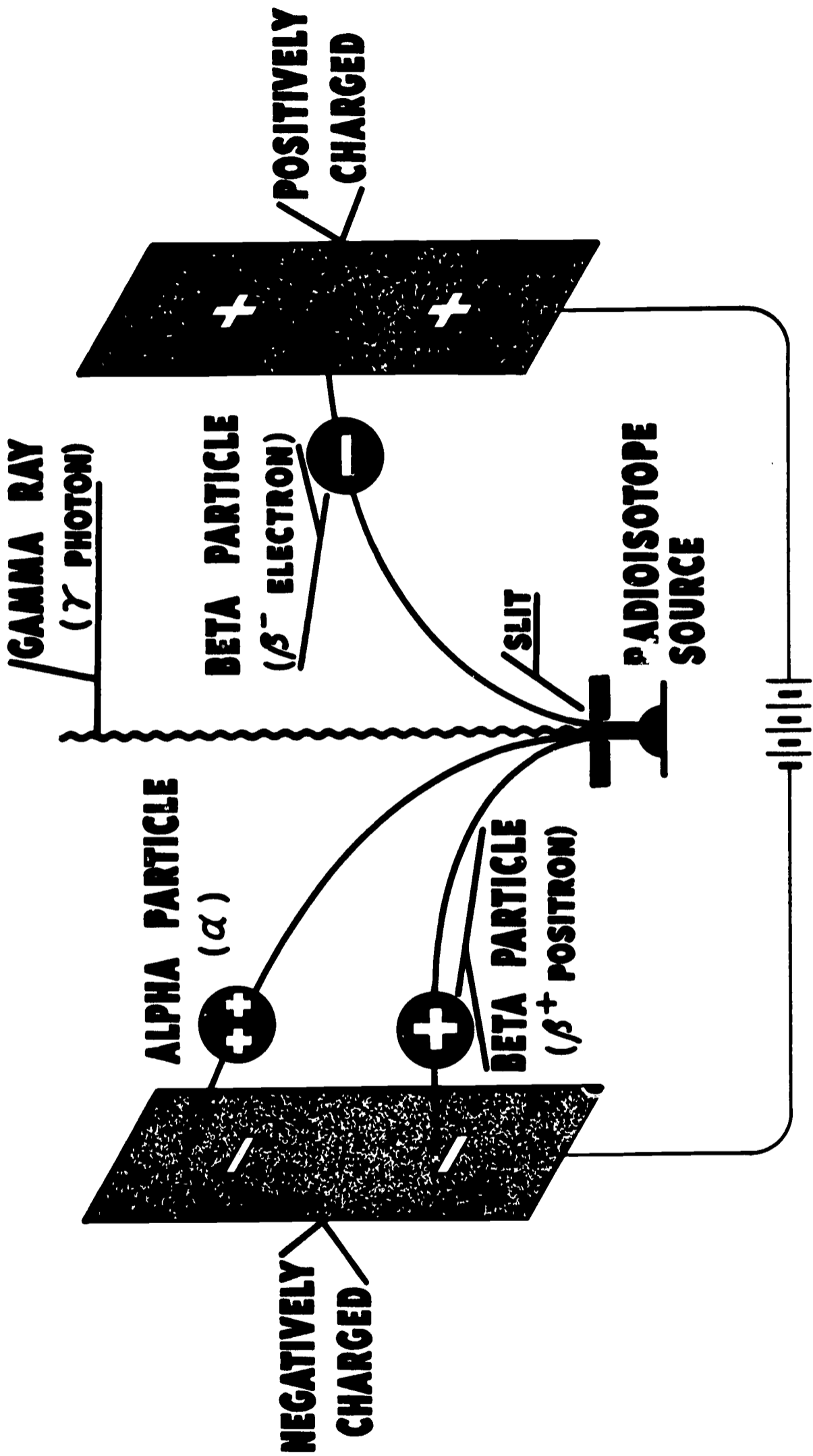

USAEC-ID-116A

IONIZATION BY CHARGED PARTICLE

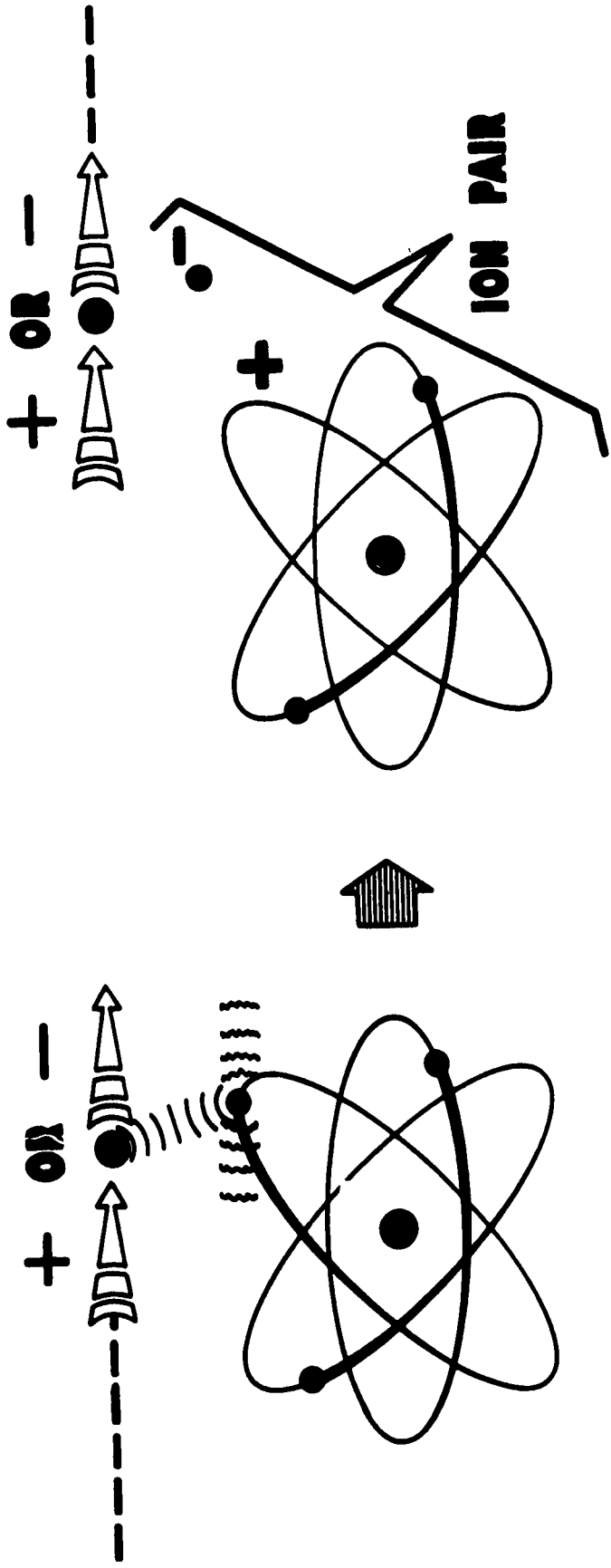

ELECTRON IS GIVEN SUFFICIENT ENERGY TO EJECT IT

IONS THEN:

- REACT CHEMICALLY WITH MATTER**
- MOVE IN ELECTRIC FIELDS**
- RECOMBINE -- EMITTING LIGHT**
- SERVE AS CONDENSATION NUCLEI**

USAEC-ID-191A

IONIZATION BY GAMMA RAYS

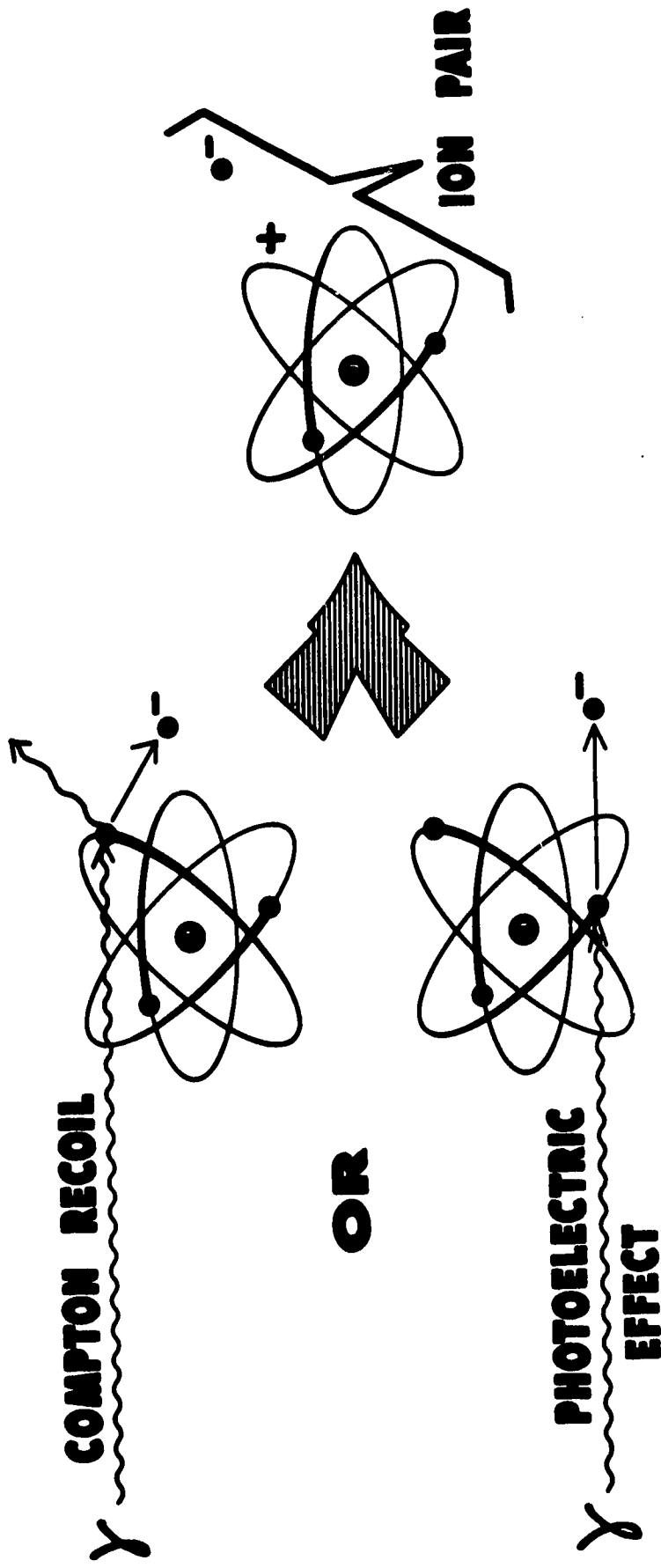

ELECTRON IS EJECTED WITH ALL OR PART OF GAMMA ENERGY

IONS THEN :-

- REACT CHEMICALLY WITH MATTER**
- MOVE IN ELECTRIC FIELDS**
- RECOMBINE -- EMITTING LIGHT**
- SERVE AS CONDENSATION NUCLEI**

USAEC-ID-192A

THE ENERGY LEVEL DIAGRAM

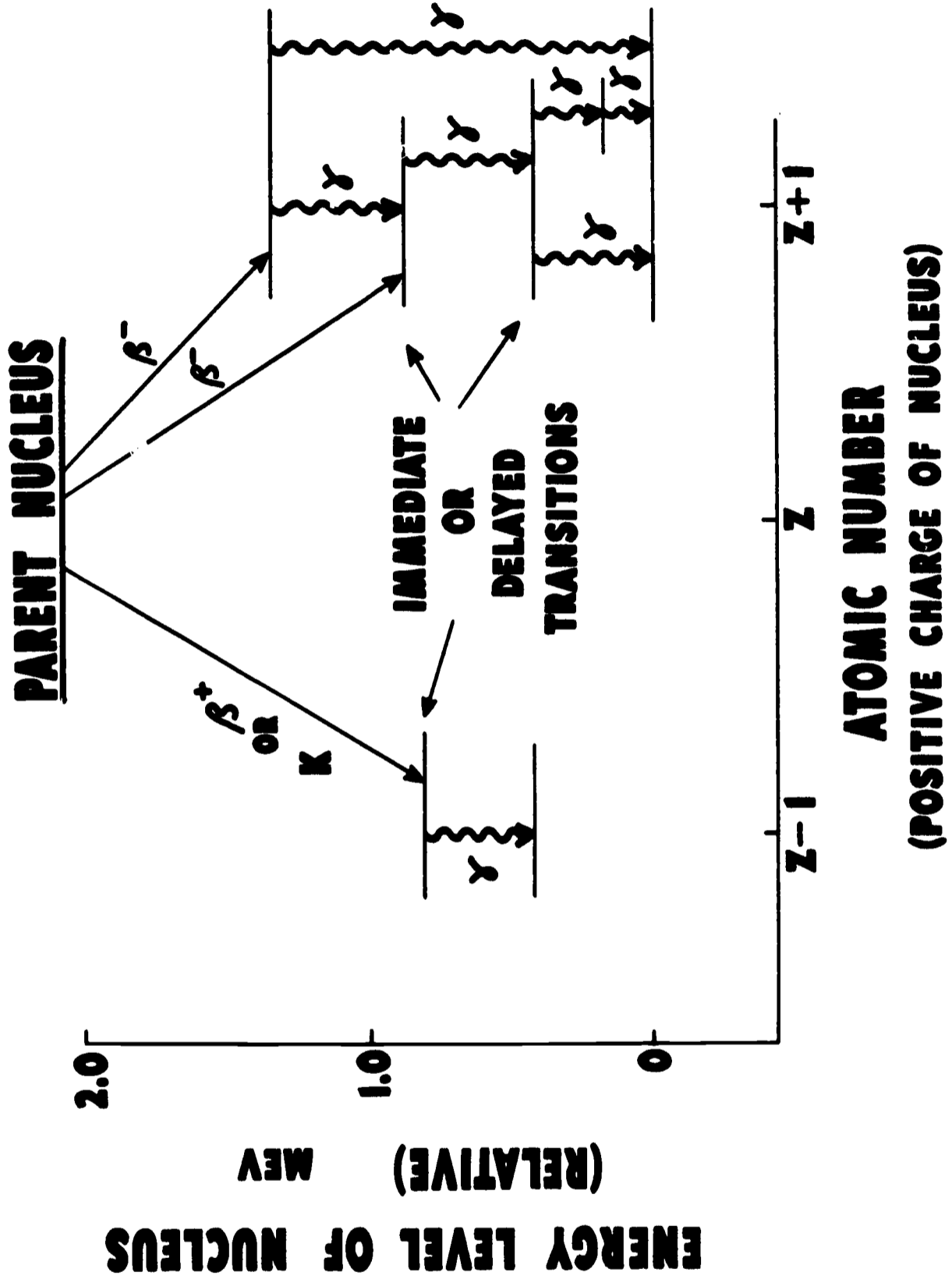

USAEC-ID-209A

BACKSCATTERING OF BETA PARTICLES

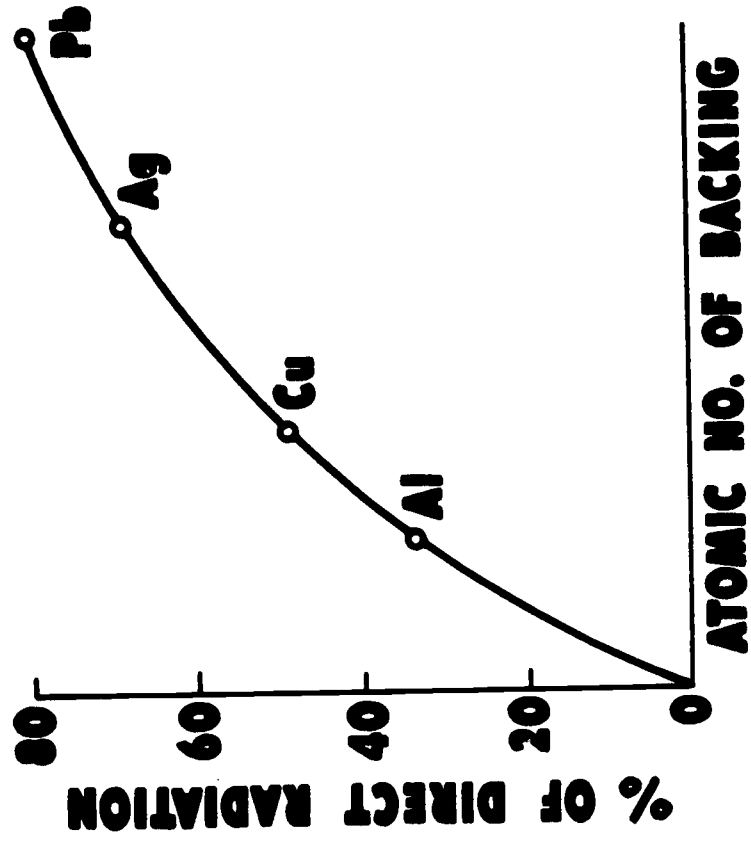

EXTENT OF "SATURATION"
BACKSCATTERING

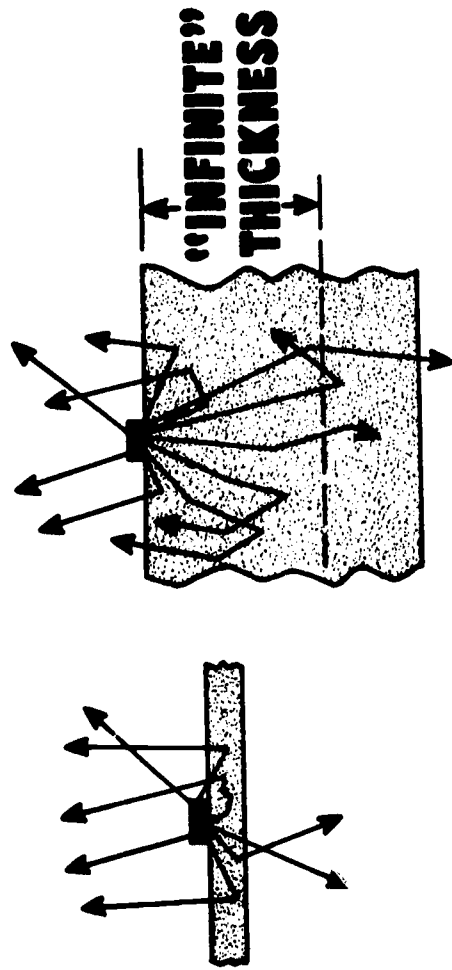

THIN
BACKING

THICK
BACKING

- BACKSCATTERING INCREASES WITH THICKNESS
- "SATURATION" OCCURS AT "INFINITE THICKNESS"
(APPROX. 1/2 MAX. RANGE)

USAEC-ID-214A

RANGE OF BETA PARTICLES

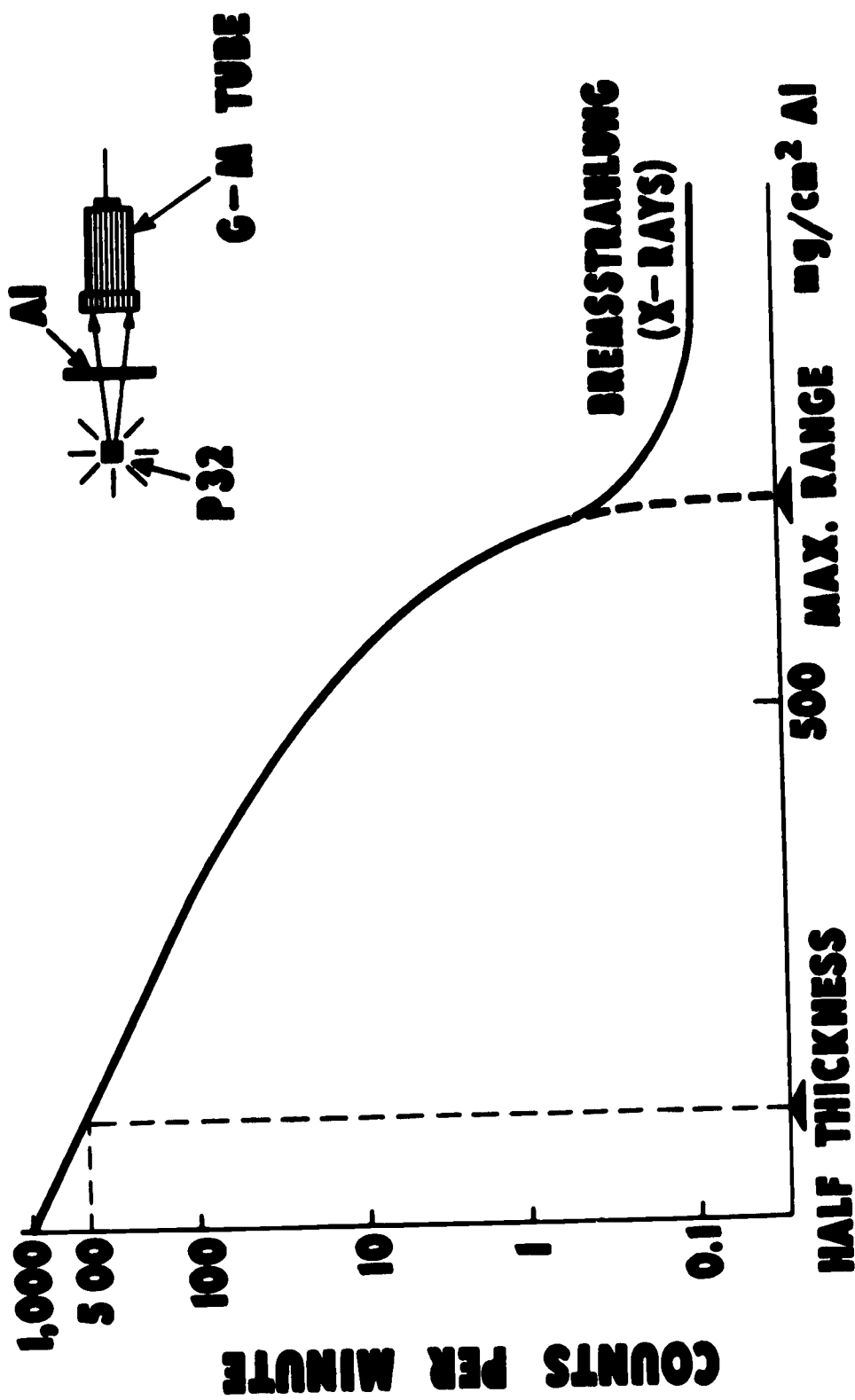

P 32 β PARTICLES IN ALUMINUM

- ABSORPTION IS PRACTICALLY EXPONENTIAL AT START
- MAXIMUM RANGE USUALLY 7 OR 8 TIMES $\frac{1}{2}$ THICKNESS

USAEC-ID-215A

GAMMA RAY INTERACTIONS

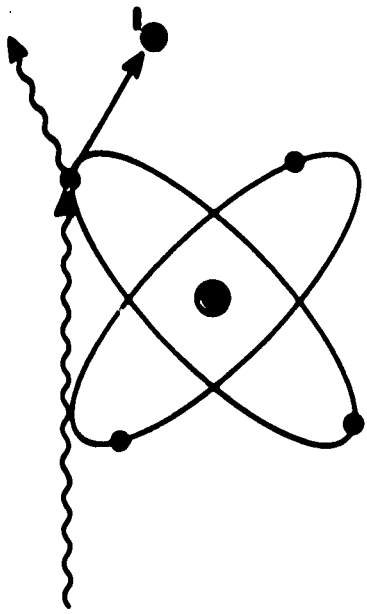

COMPTON RECOIL PROCESS

- γ RAY OF LOWER ENERGY PROCEEDS IN NEW DIRECTION
- ELECTRON IS EJECTED WITH THE ENERGY DIFFERENCE

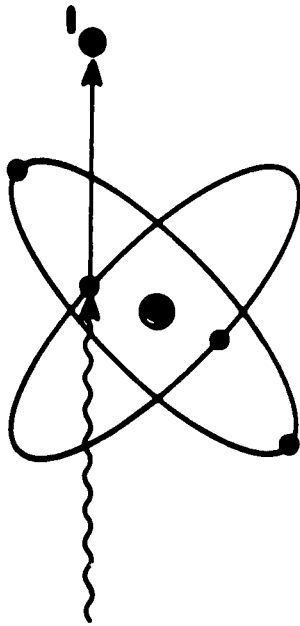

PHOTOELECTRIC PROCESS

- γ RAY COMPLETELY ABSORBED
- ELECTRON EJECTED WITH γ RAY'S ENERGY MINUS BINDING ENERGY

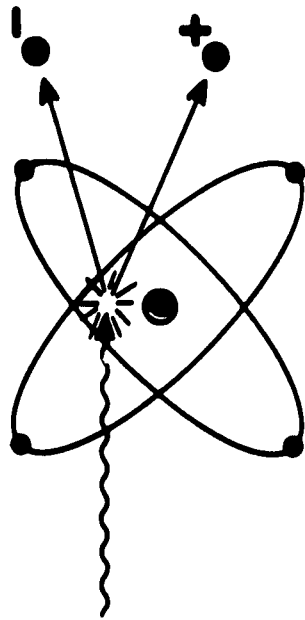

PAIR PRODUCTION PROCESS

- γ RAY ANNIHILATED
- ELECTRON AND POSITRON CREATED AND SHARE γ RAY'S ENERGY MINUS 1.02 Mev

USAEC-ID-216A

Radiation Absorption

IN VARIOUS MATERIALS

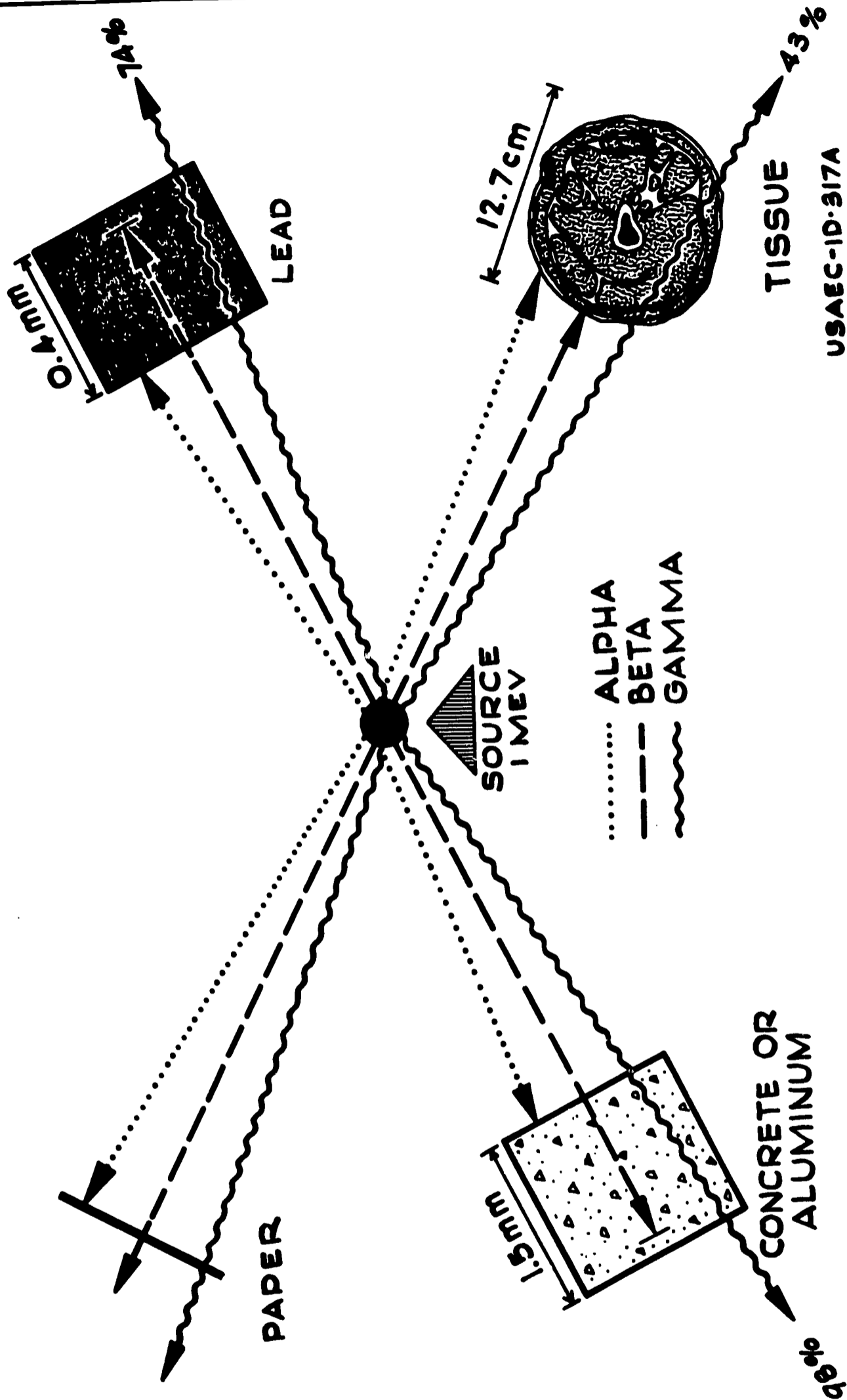

USAEC-ID-317A

USAEC Division of Technical Information Extension, Oak Ridge, Tennessee

ILLUSTRATIONS OF ISOTOPE APPLICATIONS

RADIOACTIVE ISOTOPES

FOR DISTRIBUTION STUDIES OF AN ELEMENT IN END PRODUCTS

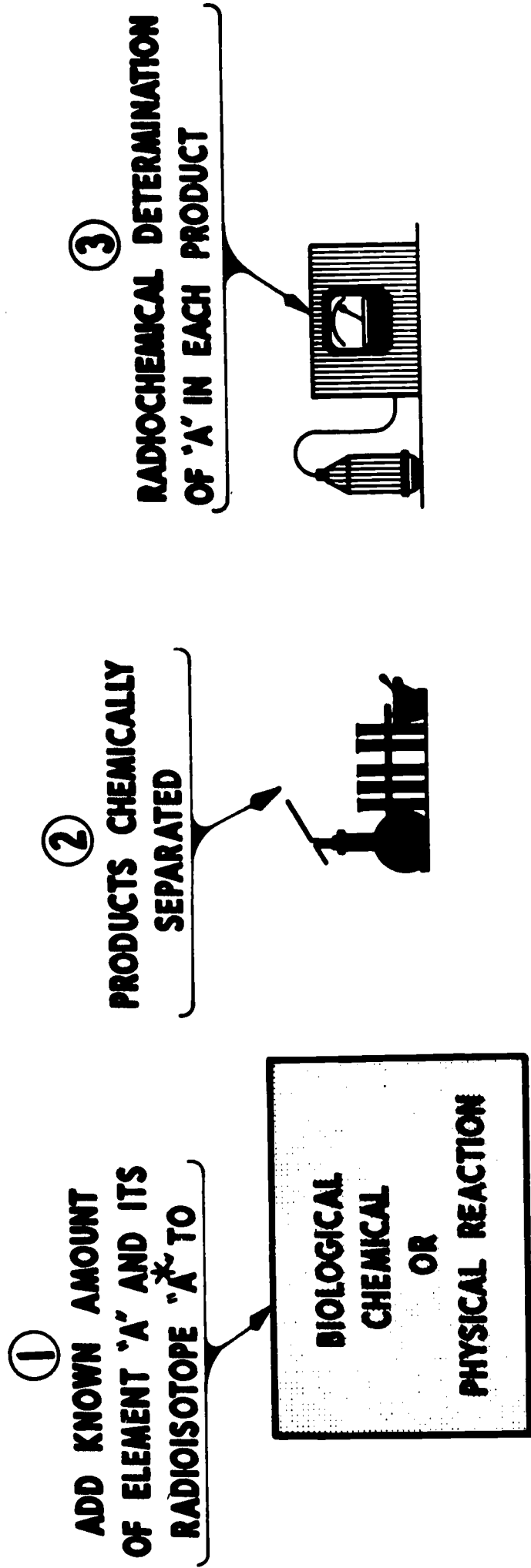

ADVANTAGES:

- 1 - RADIOCHEMICAL ANALYSIS ALONE SHOWS AMOUNT OF 'A' IN EACH PRODUCT
- 2 - SENSITIVITY IS 10^{-19} GRAMS FOR SHORT-LIVED ISOTOPE

LIMITATIONS:

- 1 - COMPLETE CHEMICAL SEPARATION REQUIRED FOR RADIOCHEMICAL ANALYSIS

USAEC-1D-238

HOW RADIOISOTOPES CAN BE USED

AS SOURCES OF RADIATION

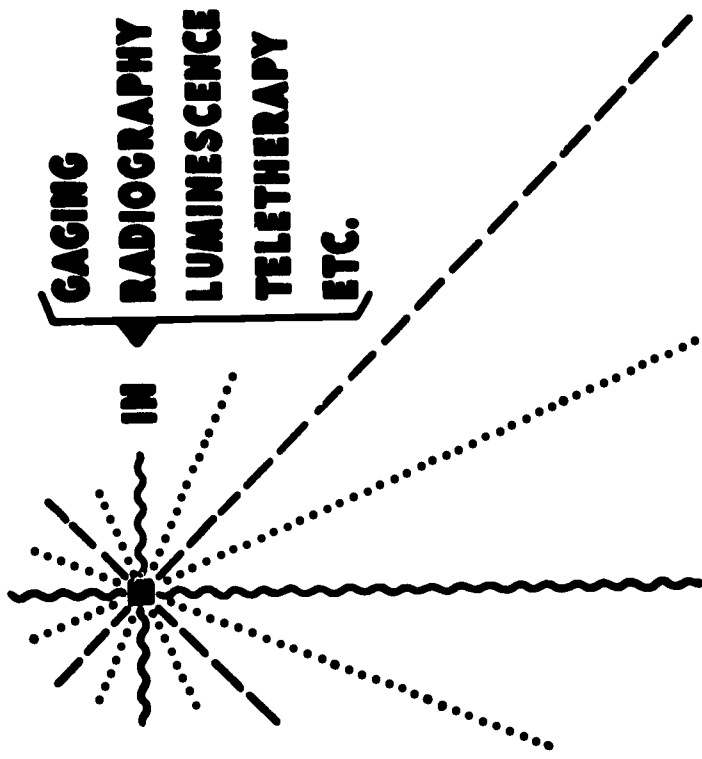

VARIETY OF RADIATIONS
LOW COST
COMPACT SOURCES OF HIGH ACTIVITY

AS TRACER ATOMS

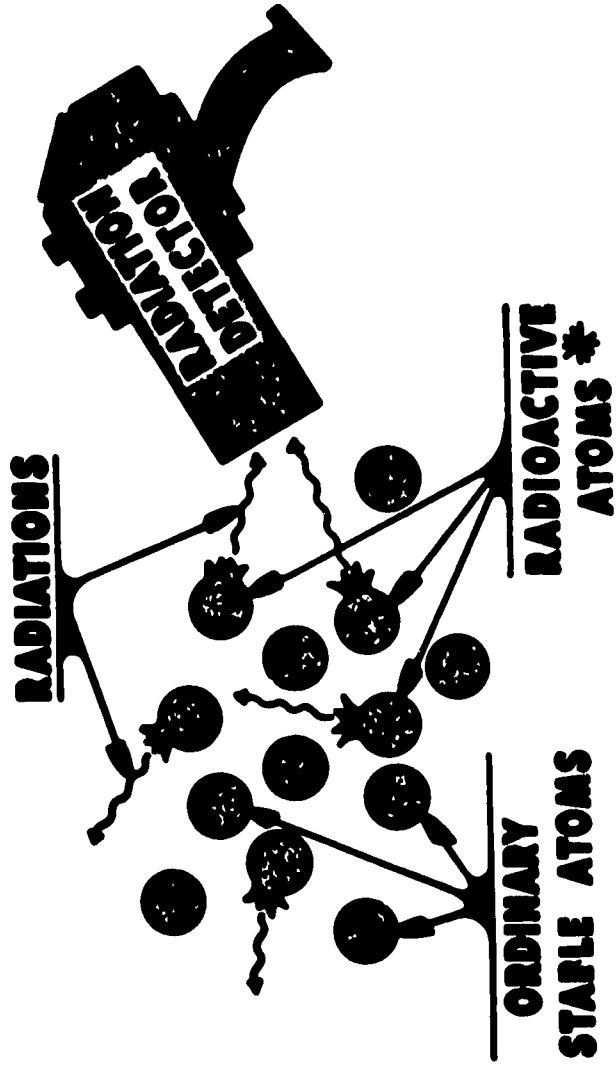

* RADIOACTIVE ATOMS BEHAVE LIKE
STABLE ATOMS —
ARE TRACED BY RADIATIONS

POWER OF ISOTOPE TRACER METHOD

SENSITIVITY :- DILUTIONS OF A TRILLION (10^{12})

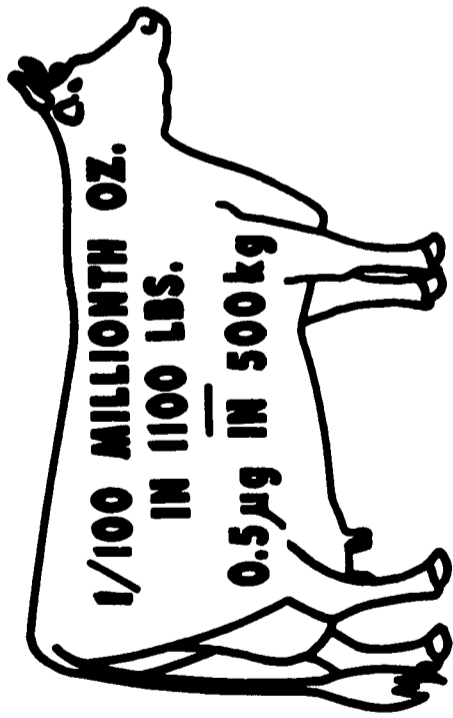

OR

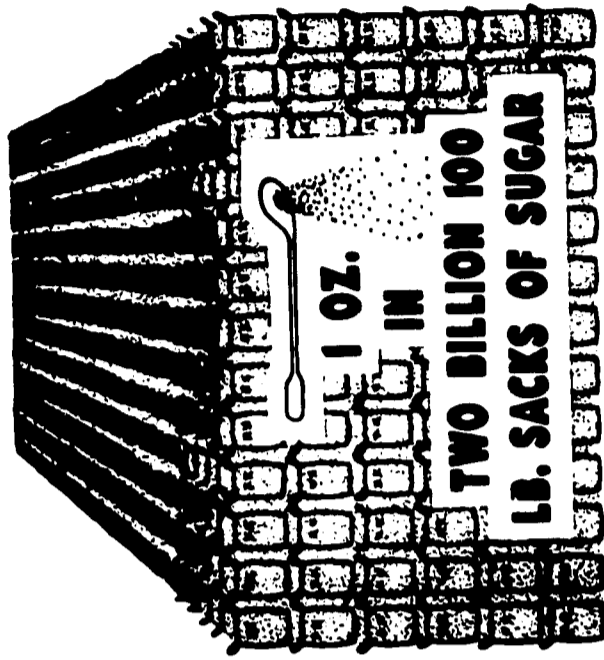

**SPECIFICITY :- CAN TRACE SPECIFIC BATCHES OF ATOMS
AND MOLECULES IN SPITE OF:**

- A - OTHER KINDS OF ATOMS AND MOLECULES**
- B - NUMEROUS AND COMPLEX CHEMICAL REACTIONS**

USAEC-ID-89A

BASIC PRINCIPLES OF RADIOISOTOPE UTILIZATION



RADIATION AFFECTS MATERIALS

MATERIALS AFFECT RADIATION

RADIATION TRACES MATERIALS

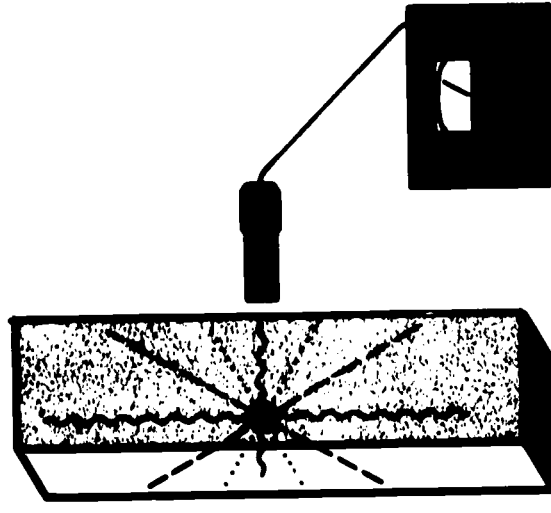
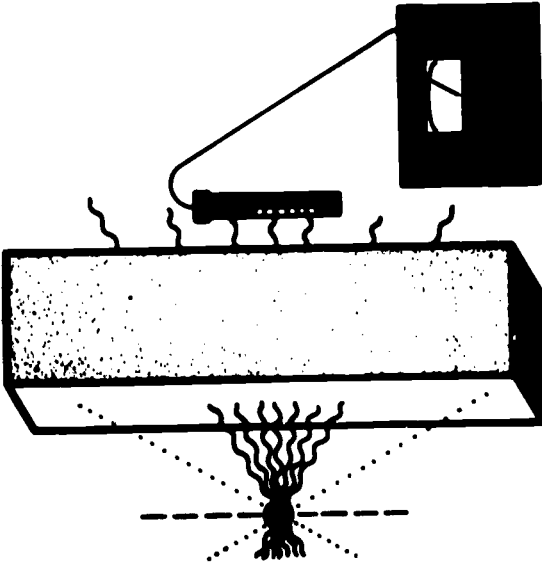
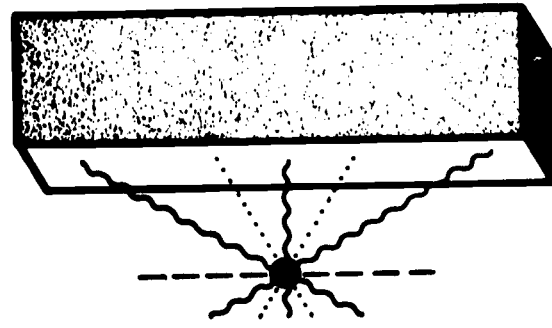

FOOD & DRUG STERILIZATION
STATIC ELECTRICITY ELIMINATION
TELE THERAPY
RADIATION GENETICS

CLINICAL RADIOGRAPHY
THICKNESS (DENSITY) GAGING
INDUSTRIAL RADIOGRAPHY
LIQUID LEVEL & HEIGHT INDICATION

METABOLIC STUDIES
FLUID FLOW
ABRASION & WEAR MEASUREMENT
STUDY OF REACTION MECHANISMS

USAC 2-29AA

Tracing with Radioisotopes

USING
CARBON-14

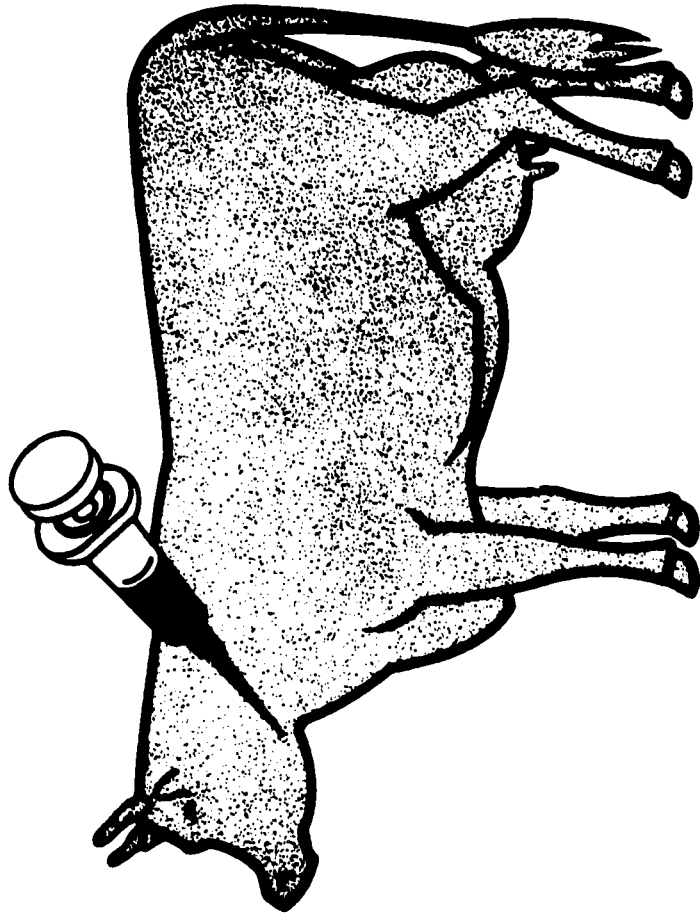

1 MILLIGRAM OF C 14 EMITS 200,000,000 RADIOACTIVE SIGNALS/SEC.

.. 1 mg C14 IN A DRUG, VITAMIN OR HORMONE INJECTED INTO
A 1000 POUND COW - CAN STILL BE MEASURED IN
10 mg AMOUNTS OF BLOOD, MILK OR TISSUE.

USAEC-10-299A

RADIOACTIVITY HAS LABELED AND TRACED

ELEMENTS

HYDROGEN

CARBON

PHOSPHORUS

CALCIUM

COPPER

GOLD

MENDELEVIVUM
(101)

BIOCHEMICALS

AMINO ACIDS

SUGARS

STARCH

VITAMINS

HORMONES

ANTIBIOTICS

CARCINOGENS

MATERIALS

WATER

SALT

SOAP

WAXES

GASOLINE

PISTON RINGS

RUBBER

ORGANISMS

BLOOD CELLS

VIRUSES

BACTERIA

MOSQUITOES

BETLES

BIRDS

RATS

USAEC-ID-329A

INDUCTION OF RADIOACTIVITY FOR ACTIVATION ANALYSIS



①
SAMPLE CONTAINING
UNKNOWN ELEMENTS

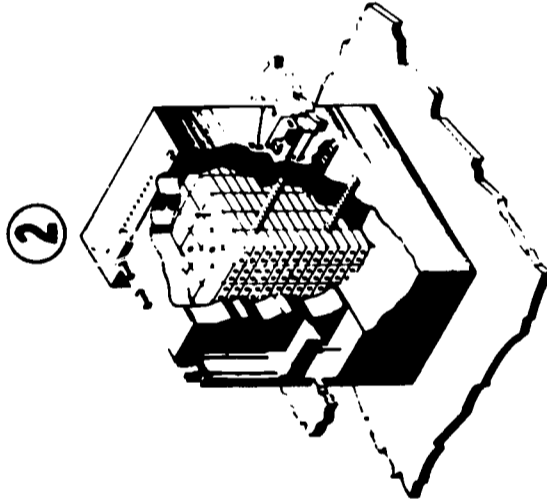

②
SAMPLE IRRADIATED WITH
NEUTRONS IN NUCLEAR
REACTOR

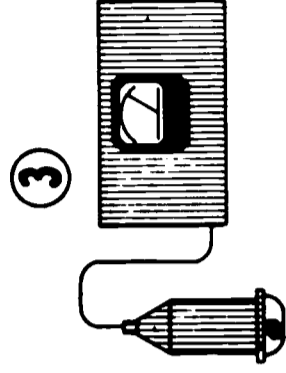

③
INDUCED RADIOISOTOPES
IDENTIFIED BY RADIATION
CHARACTERISTICS

ADVANTAGES:

- 1 - ELIMINATES TEDIOUS CHEMICAL PROCEDURES
- 2 - MORE SENSITIVE THAN CHEMICAL AND SPECTROSCOPIC METHODS
- 3 - METHOD IS BOTH QUALITATIVE AND QUANTITATIVE

DISADVANTAGES:

- 1 - LARGE SOURCE OF NEUTRONS SUCH AS A REACTOR IS NEEDED
- 2 - SIMILAR RADIATION PROPERTIES MAY PREVENT DIFFERENTIATION OF INDUCED RADIOISOTOPES

ID-USAE C

RADIOACTIVE ISOTOPES FOR ISOTOPE DILUTION ANALYSIS

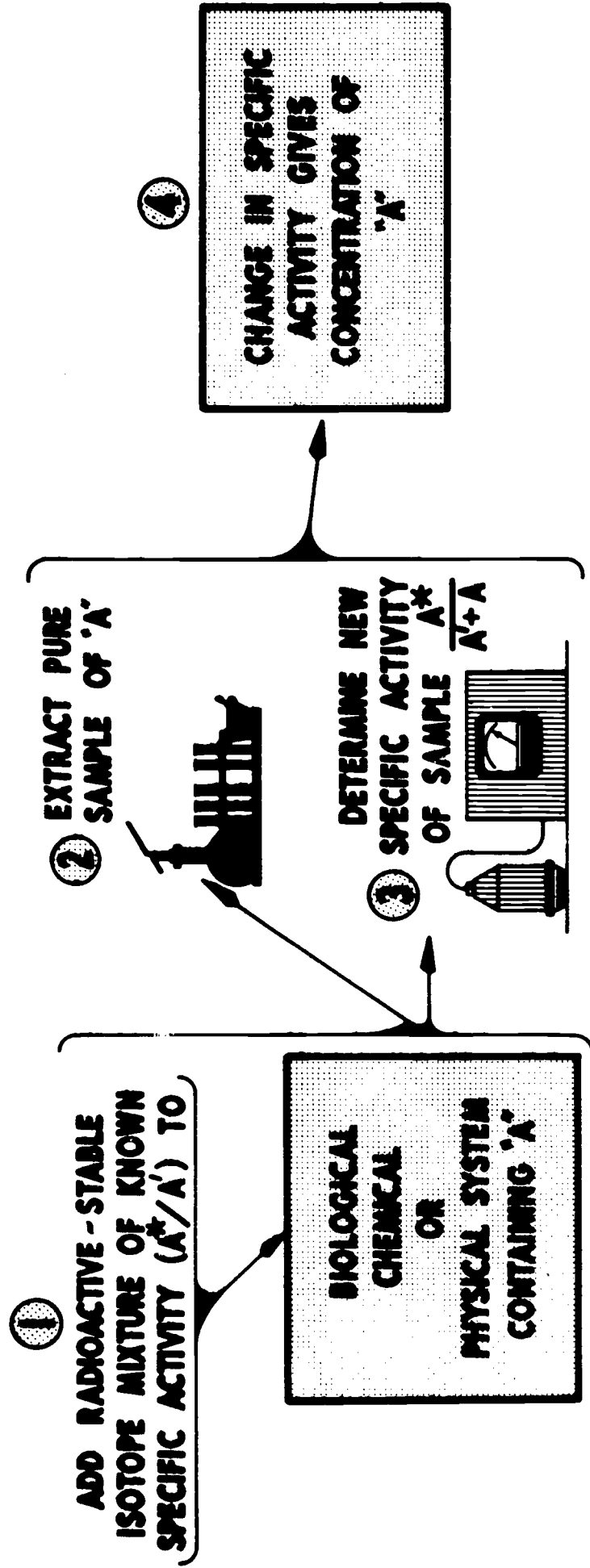

ADVANTAGES:

- 1- SENSITIVITY MANY TIMES GREATER THAN CHEMICAL ANALYSIS
- 2- QUANTITATIVE CHEMICAL SEPARATION PROCEDURES NOT NECESSARY

LIMITATIONS:

- 1- SPECIFIC ACTIVITY SHOULD CHANGE BY A FACTOR OF 2 OR MORE
- 2- a. ISOTOPE MIXTURE ADDED
b. SAMPLE ISOLATED FOR ANALYSIS } MUST BE CHEMICALLY PURE

ID-USAEC

**ILLUSTRATIONS OF ISOTOPE APPLICATIONS
IN BIOLOGY AND MEDICINE, RESEARCH**

RADIOACTIVE CARBON - C 14 FOR STUDYING FATE OF LABELED STEROIDS

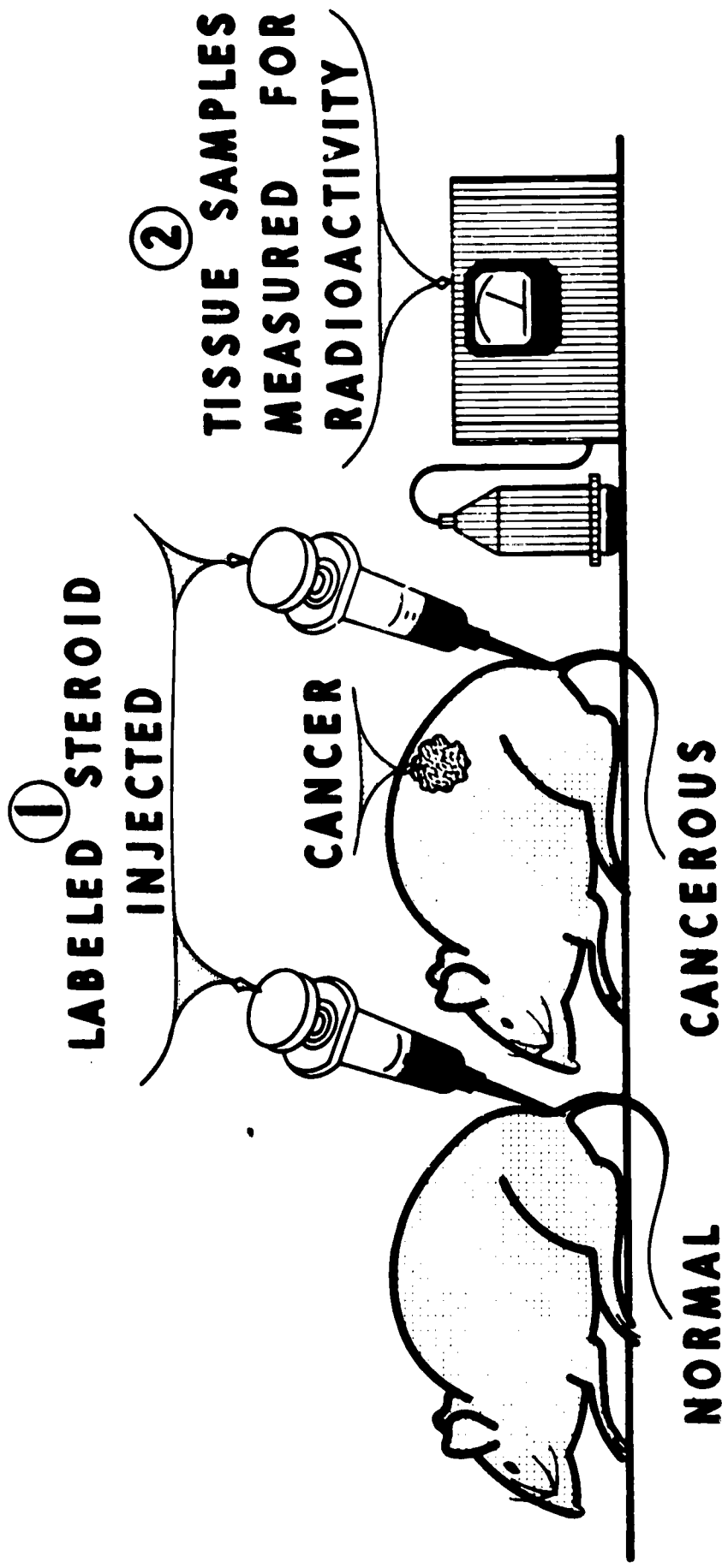

INDICATES:

- 1- UPTAKE OF STEROIDS IN VARIOUS ORGANS
- 2- FATE OF STEROIDS IN EACH ANIMAL
- 3- REASONS FOR DIFFERENCES DUE TO DISEASE

USAEC-1D-178

RADIOACTIVE SULFUR - S35

FOR STUDY OF BODY'S USE OF AMINO ACIDS

- ① **S35 INCORPORATED IN AMINO ACIDS:**
- 1-METHIONINE**
 - 2-GLUTATHIONE**
 - 3-CYSTINE**
- ESSENTIAL BUILDING BLOCKS
FOR TISSUE FORMATION**

② **LABELED AMINO ACIDS FED**

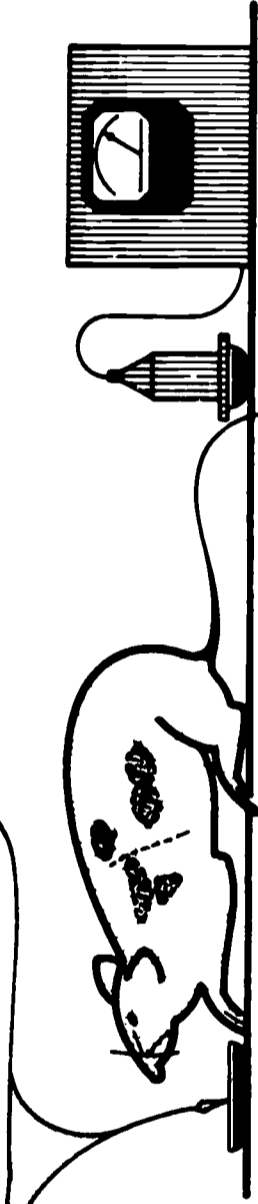

③ **TISSUE SAMPLES MEASURED
FOR S35 CONTENT**

SHOWS:

- 1- UPTAKE OF AMINO ACIDS IN VARIOUS ORGANS**
- 2- HOW AMINO ACIDS ENTER INTO BODY PROCESSES**
- 3- DIFFERENCE IN UPTAKE AND USE DUE TO DISEASES**
 - CANCER - CIRRHOSIS - DIABETES - VITAMIN DEFICIENCY**

USAEC-1D-182

RADIOACTIVE IRON - Fe 59

FOR STUDYING WHOLE BLOOD PRESERVATION

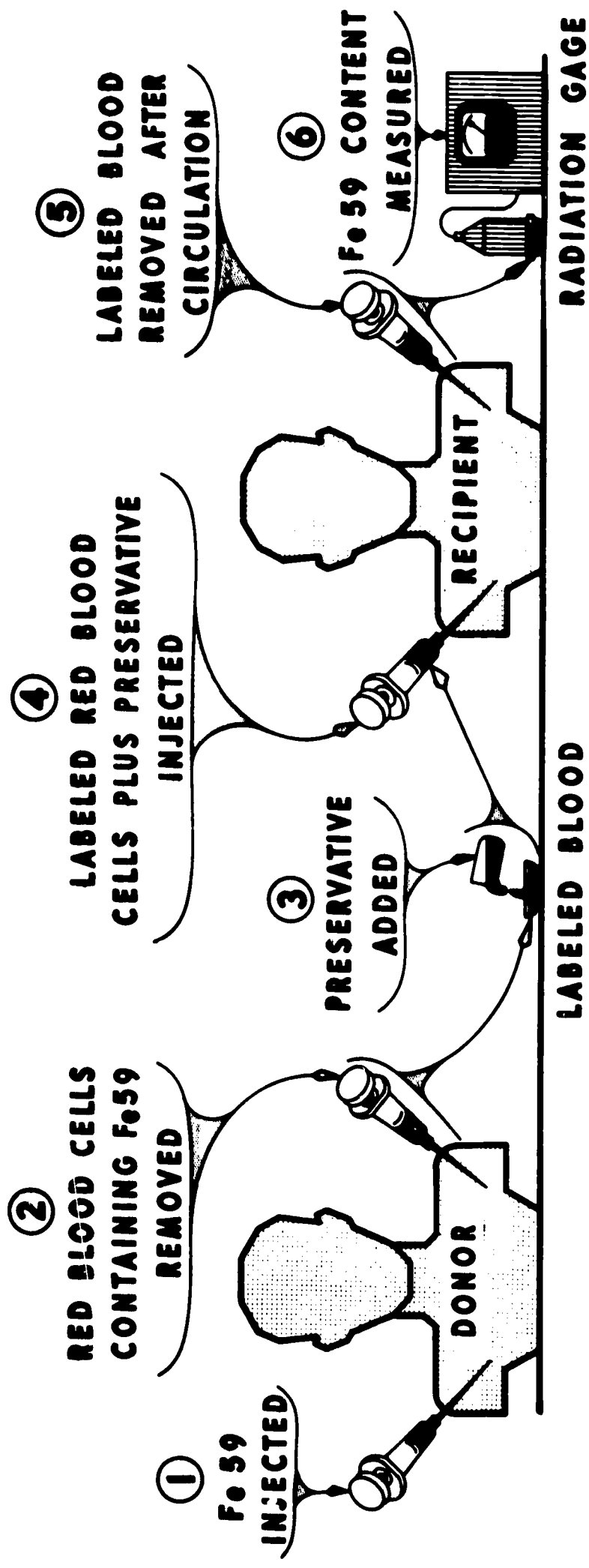

SHOWS:

- 1 - Fe 59 IN BLOOD AS FUNCTION OF CIRCULATION TIME
- 2 - LIFE SPAN OF TRANSFUSED BLOOD CELLS
- 3 - EFFECTIVENESS OF BLOOD PRESERVATIVE

RADIOACTIVE SODIUM - Na 24

FOR STUDYING SODIUM TURNOVER IN BODY

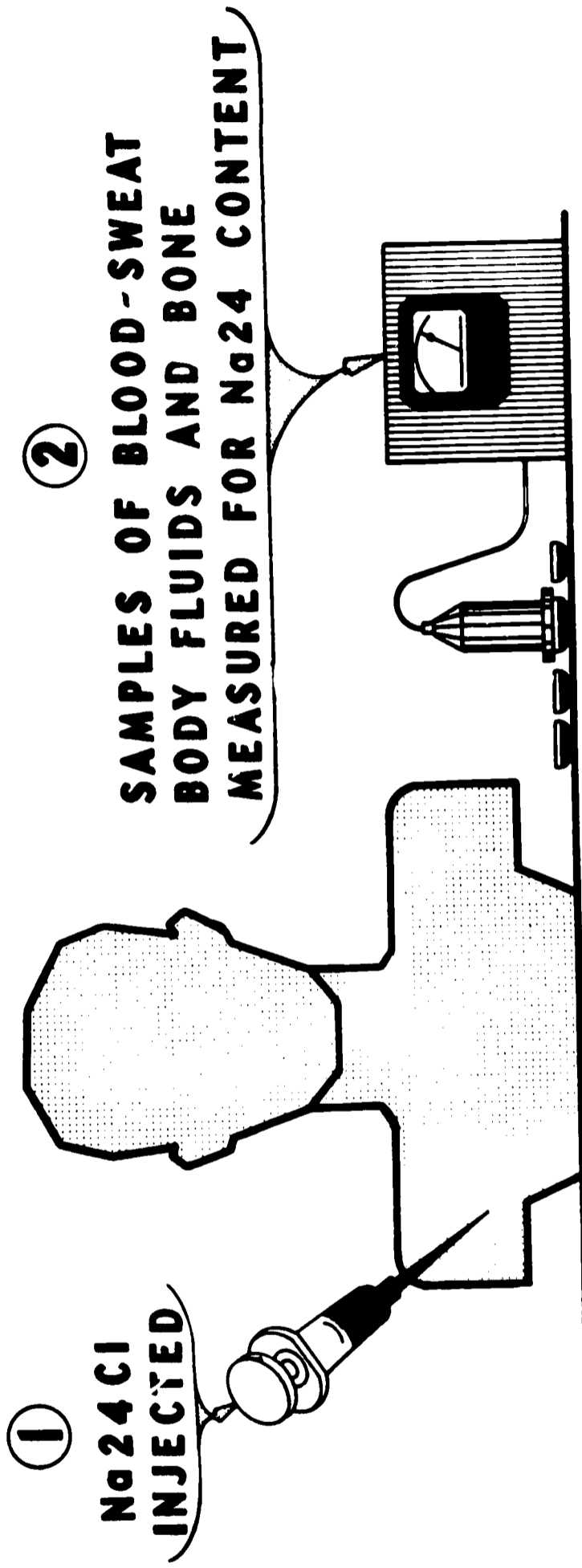

SHOWS:

RATES OF SODIUM TRANSFER THRU BLOOD VESSEL WALLS

**1 - FAST { TO TISSUE FLUIDS - 50 lbs. SALT PER DAY
 { TO SWEAT IN 75 SECONDS**

2 - MEDIUM - TO FLUID OF EYE - BRAIN - SPINAL CORD

3 - SLOW - TO BONES AND TEETH

USAEC-D-188

RADIOACTIVE CARBON - C14

FOR STUDYING CANCER PRODUCING AGENTS - CARCINOGENS

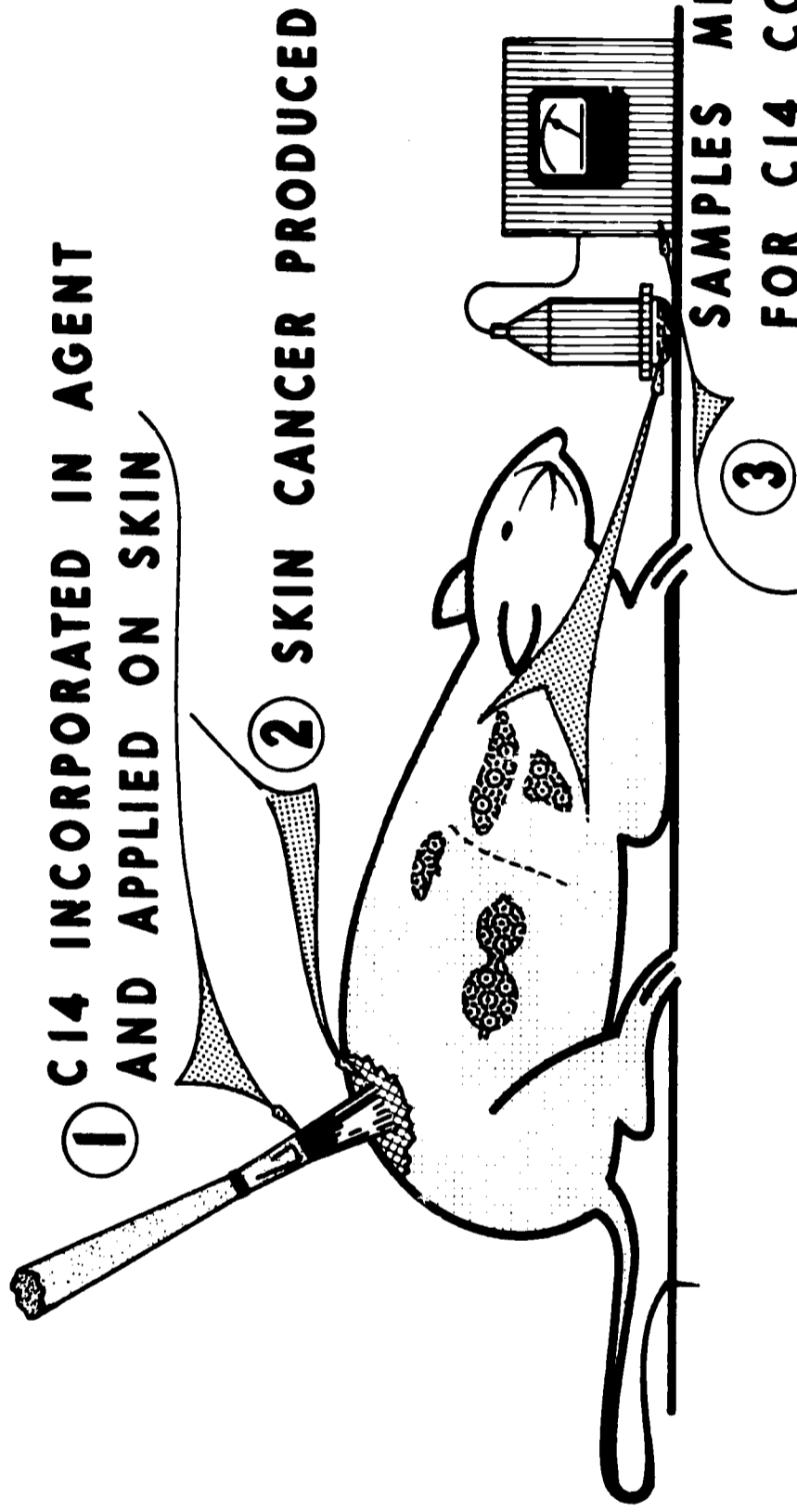

SHOWS:

- 1 - AMOUNT OF AGENT IN CANCER AND OTHER TISSUE**
- 2 - LOCATION OF BREAKDOWN PRODUCTS OF THE AGENT**
- 3 - MODE OF ACTION OF CANCER PRODUCING AGENT**

RADIOACTIVE TRACERS

FOR STUDYING PERMEABILITY OF CELL MEMBRANES

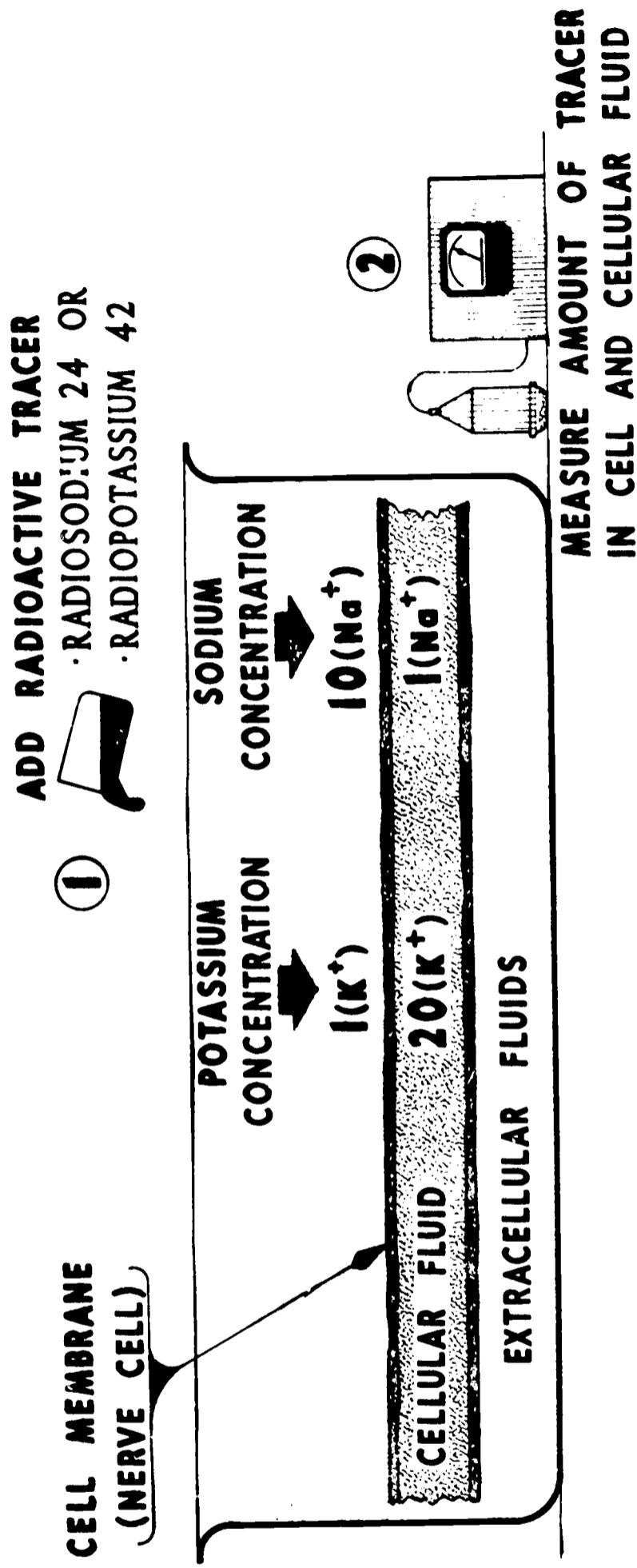

SHOWS:

- 1- RAPID TRANSFER OF ATOMS ACROSS CELL MEMBRANE
- 2- TRANSFER THROUGH MEMBRANE IS COMPLICATED EXCHANGE PROCESS
- 3- RATE OF TRANSFER DEPENDS ON ENZYMES AND CONDUCTION

RADIOACTIVE CARBON - C14

FOR STUDYING THE FATE OF AN INJECTED DRUG

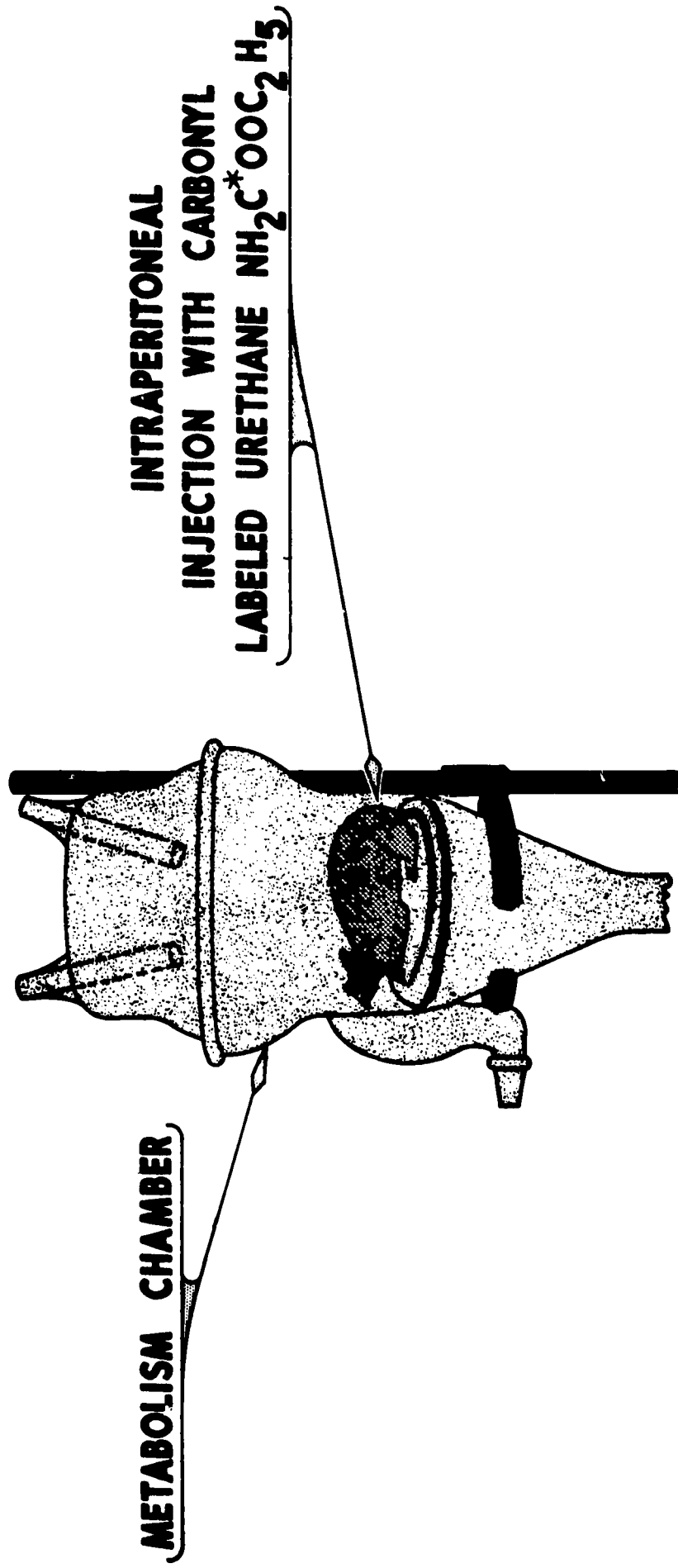

SHOWS:

- 1- IN NORMAL ANIMAL 90% C14 ELIMINATED IN 24 HOURS AS C*O₂
- 2- RETENTION OF C14 HIGHER IN CANCEROUS AND LEUKEMIC ANIMALS
- 3- SLOWER RATE OF CATABOLISM OF URETHANE IN NEOPLASTIC ANIMALS

ISOTOPES FOR TRACER STUDIES IN CLINICAL RESEARCH

VITAMINS
HORMONES
STEROIDS
AMINO ACIDS
PHOSPHOLIPIDS
ETC.

FATE OF NORMAL METABOLITES

ANTIBIOTICS
ANESTHETICS
BACTERICIDES
ALKALOIDS
ETC.

ACTION OF DRUGS

VIRUSES
BACTERIA
RADIATION
CARCINOGENS
TOXICANTS
ETC.

ACTION OF INJURIOUS AGENTS

USAEC-ID-82A

COMBINATION BLOCKING IN CHEMOTHERAPY

SEQUENTIAL OR CONCURRENT

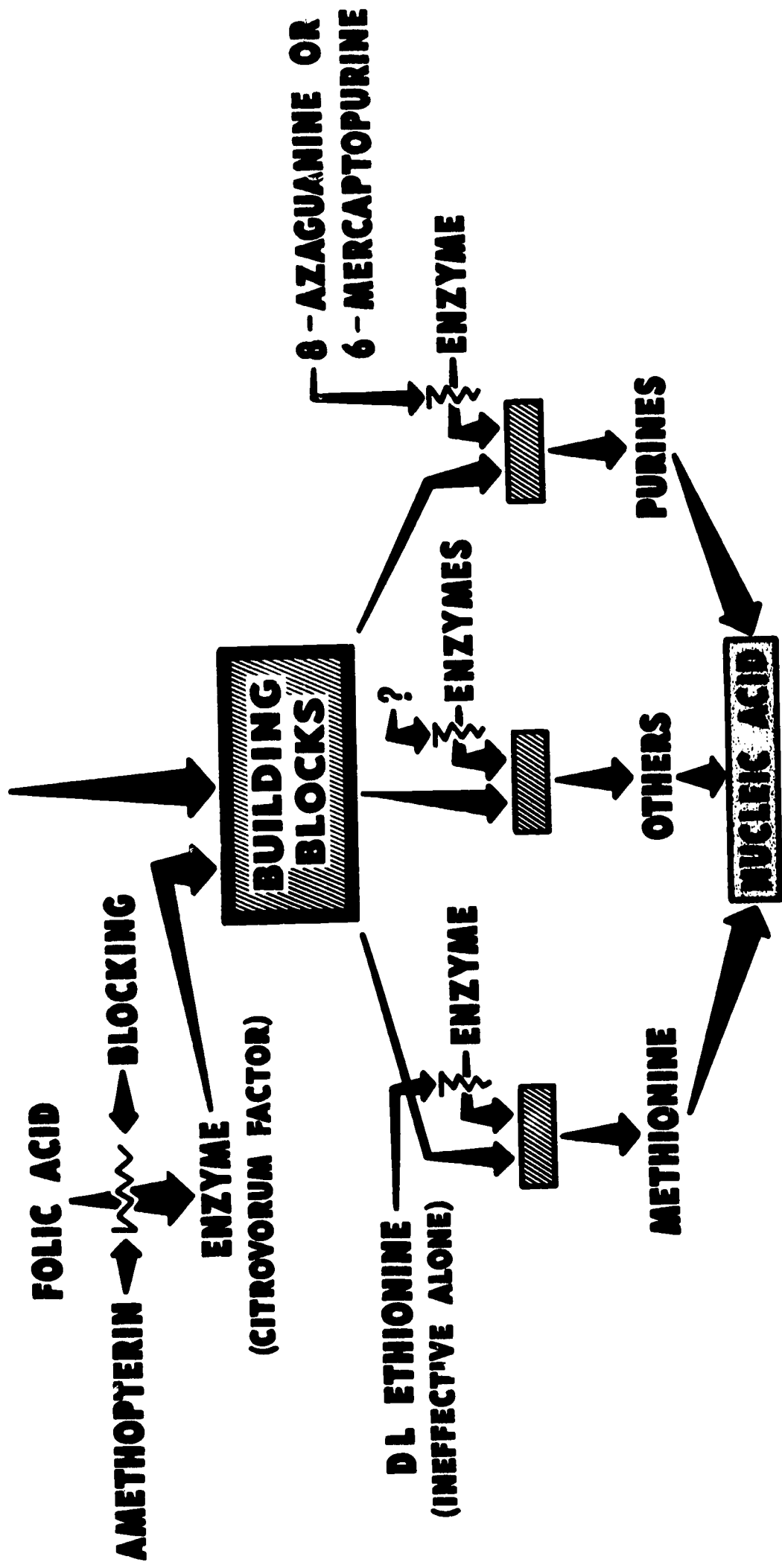

--ANTIMETABOLITE DRUGS BLOCK ESSENTIAL ENZYMES--

--COMBINATION BLOCKS SEVERAL ENZYMES -- RESULTS MORE EFFECTIVE--

USAEC-ID-219A

ISOTOPIC COMPETITION METHOD IN STUDY OF AMINO ACID PRECURSOR SCHEMES

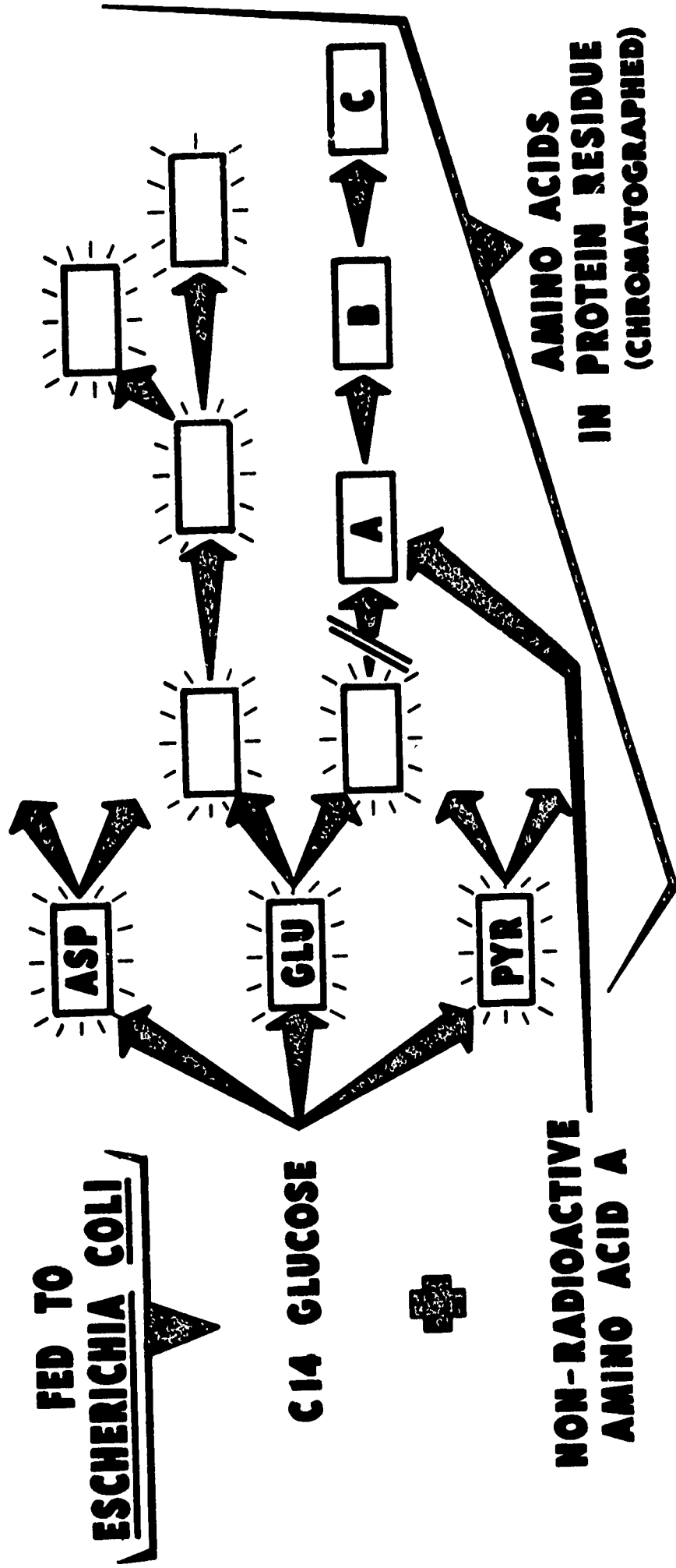

NON-RADIOACTIVE AMINO ACID A

AMINO ACIDS IN PROTEIN RESIDUE (CHROMATOGRAPHED)

- WITHOUT ADDED (A) — RADIOACTIVITIES SHOW RELATIVE CONTENT
- ADDED (A) COMPETES SUCCESSFULLY WITH ENDOGENOUS (A)
- REDUCED ACTIVITY OF (B) AND (C) SHOWS (A) IS PRECURSOR

USAEC-ID-220A

CONSIDERATIONS IN INTERNAL USE OF RADIOISOTOPES

1 - RADIATION HAZARDS AND COMPETITION BETWEEN TISSUES

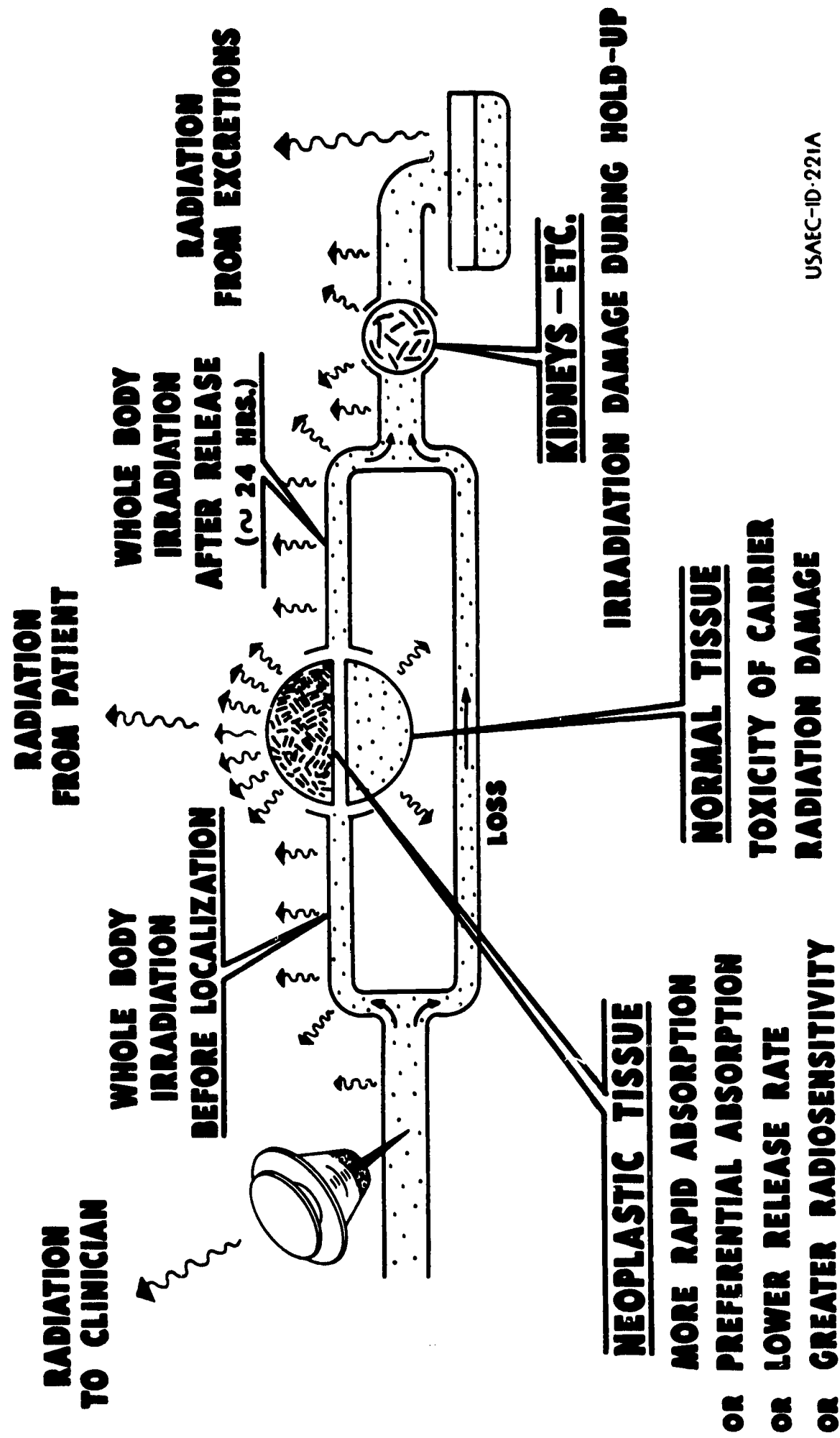

USAEC-ID-221A

CONSIDERATIONS IN INTERNAL USE OF RADIOISOTOPES

2-- UPTAKE -- RETENTION -- DECAY TIMES

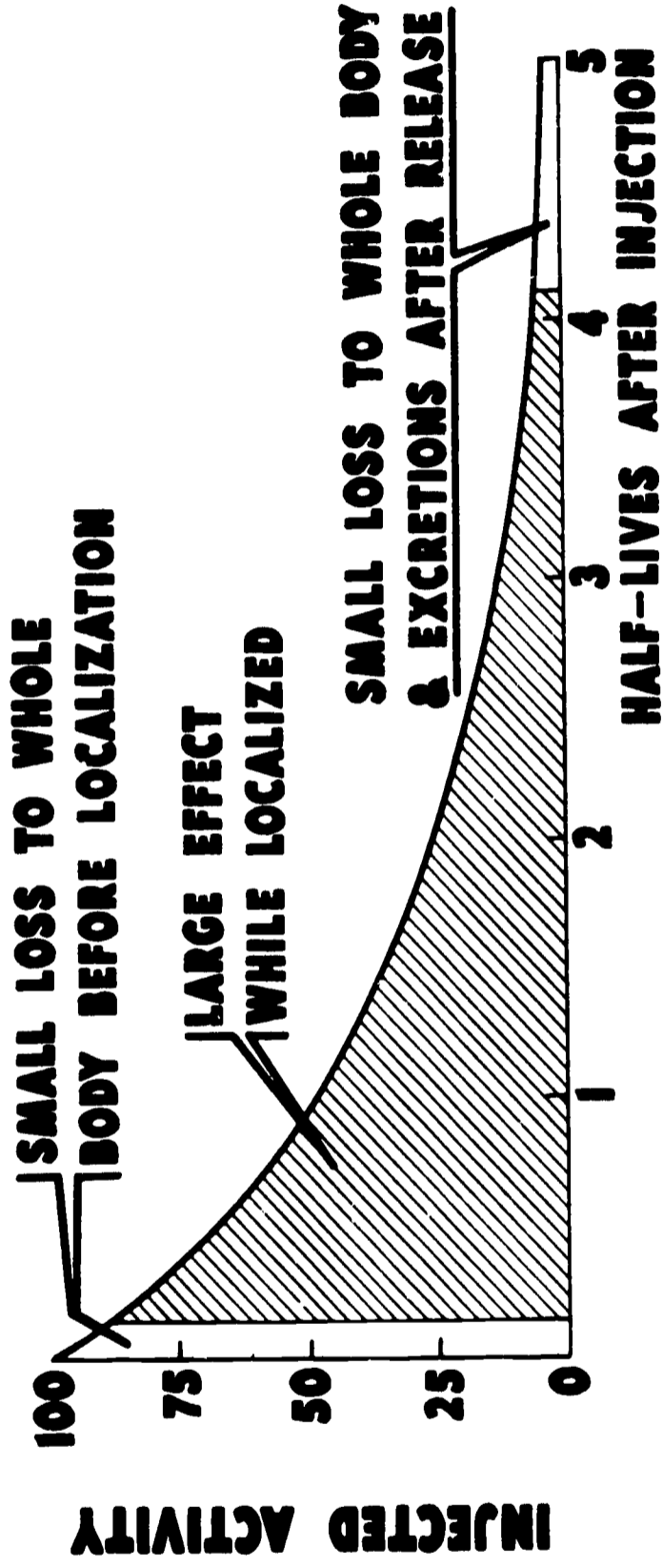

IDEAL UPTAKE -- RETENTION -- HALF-LIFE COMBINATION

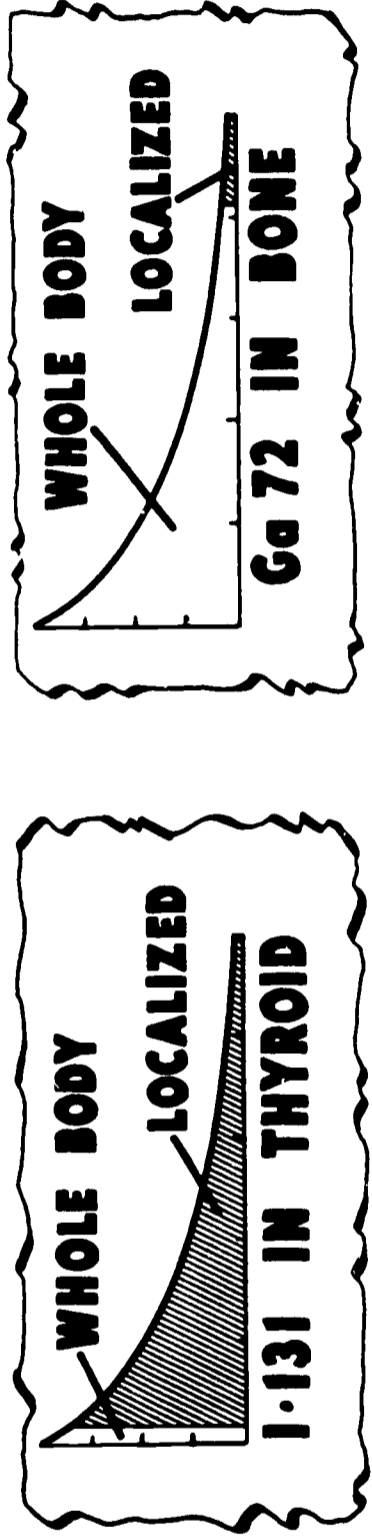

USAEC-ID-222A

CANCER STUDIES AIDED BY RADIOISOTOPES

CITRIC ACID CYCLE

NUCLEIC ACID METABOLISM

ANTICANCER DRUGS

ENZYME INHIBITORS
NITROGEN MUSTARDS
METABOLIC SUBSTITUTES

SYSTEMIC EFFECTS OF CANCER

FUNCTIONING OF OTHER TISSUES
ANEMIA

CARCINOGENS

RADIATION
AMINOAZO DYES
HYDROCARBONS

INTRACELLULAR RADIATION EFFECTS

USAEC-ID-234A

Continuous Metabolic Measurement

USING CARBON 14

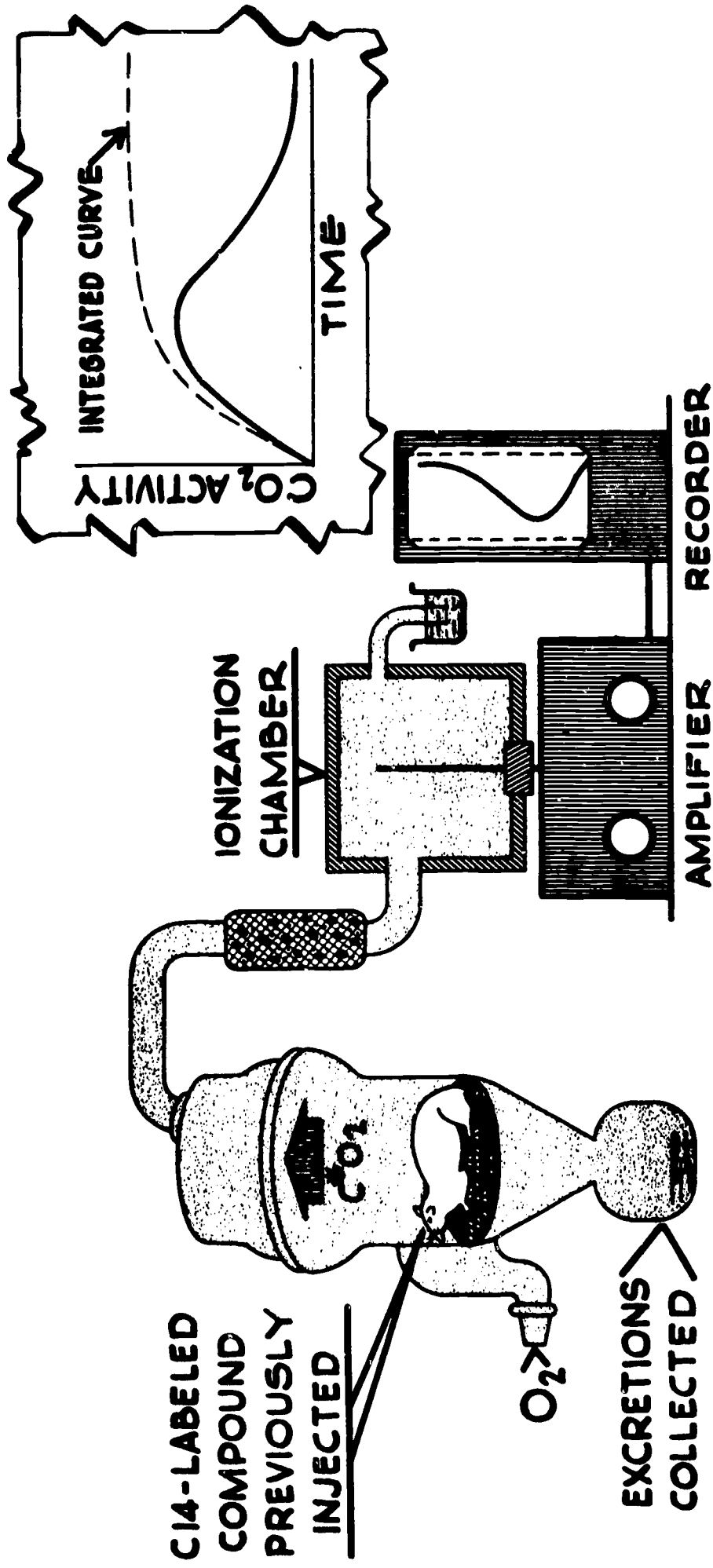

- SHOWS:**
- 1- CONTINUOUS RATE OF BREAKDOWN TO CO₂
 - 2- RAPID METABOLISM OF MOST COMPOUNDS
 - 3- DIFFERENCES DUE TO DRUG ACTION OR DISEASE

ID: USAEC-276A

Biological Synthesis

LABELED COMPOUNDS (BUFAGIN)

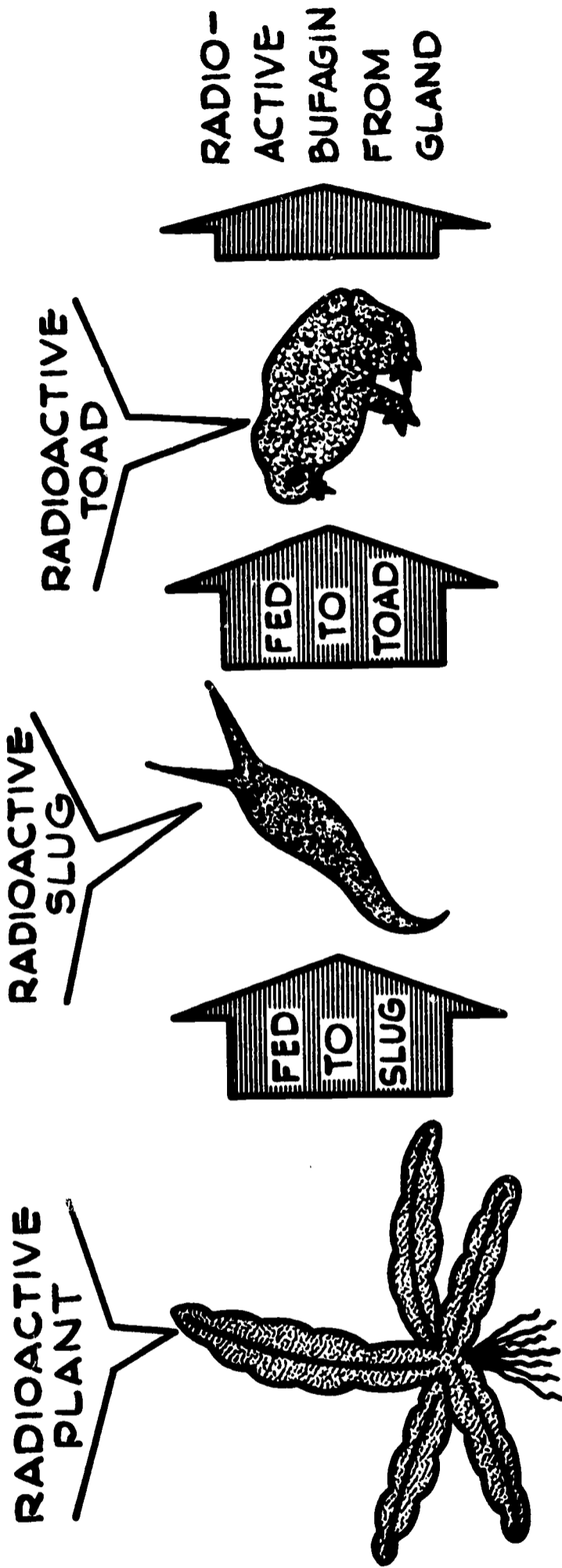

- . SECRETION FROM TOAD (BUFAGIN) USED FOR TREATMENT OF HEART DISEASE.
- . RADIOACTIVE BUFAGIN USED TO STUDY ACTION OF THIS DRUG.

USAEC-ID-285A

RADIOACTIVE IODINE - I-131 FOR AUTORADIOGRAPHIC EXAMINATION OF THYROID GLAND

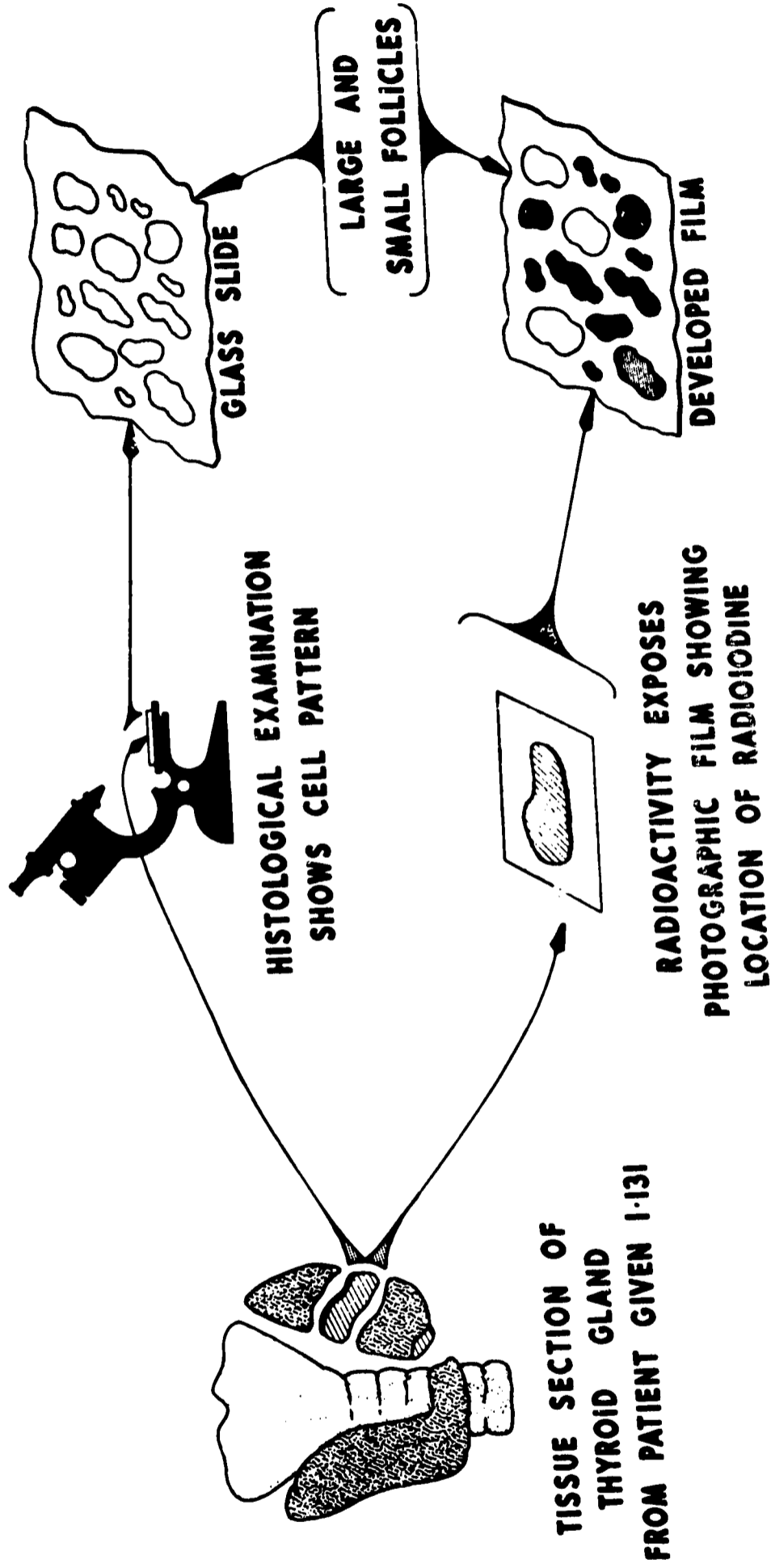

SHOWS:

- 1 - IODINE TAKEN UP BY FOLLICLES OF THYROID GLAND
- 2 - SMALL FOLLICLES CONCENTRATE I-131 MORE RAPIDLY
- 3 - GREATER UPTAKE IN ACIDOPHILIC THAN BASOPHILIC FOLLICLES

USAEC-ID 313A

RADIOACTIVE IODINE - I-131 FOR STUDYING THYROID GLAND PHYSIOLOGY

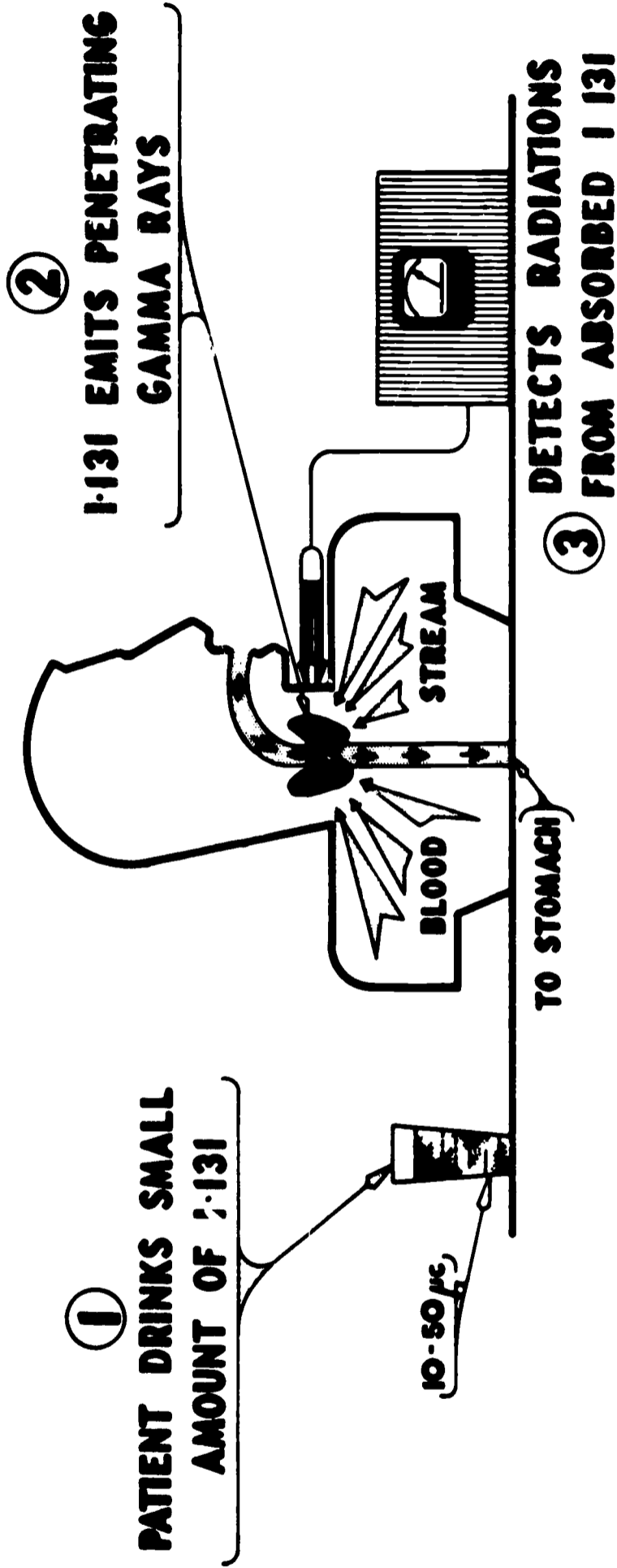

SHOWS:

- 1- THYROID GLAND TAKES UP MOST RADIOIODINE RETAINED BY BODY
- 2- IODINE ABSORPTION PROPORTIONAL TO PRODUCTION OF THYROXINE
- 3- RELATIVE ABSORPTION SHOWS PHYSIOLOGICAL ACTIVITY OF GLAND

ID-USAEC

STUDY OF IRON PHYSIOLOGY

WITH
RADIOACTIVE IRON Fe59

①

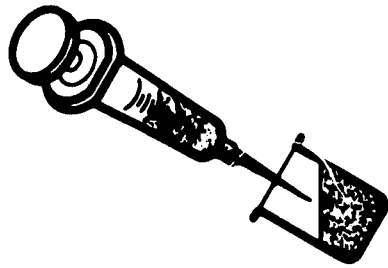

Fe Cl₃ ADDED TO
PATIENT'S PLASMA

②

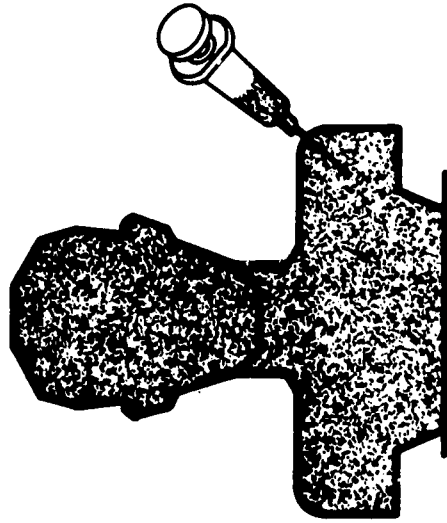

LABELED PLASMA INJECTED
AND BLOOD SAMPLES
REMOVED AT TIMED INTERVALS

③



TOTAL IRON AND Fe59
DETERMINED IN
PLASMA ALIQUOTS

SHOWS PLASMA IRON TURNOVER TO BE:

- 1--SENSITIVE INDICATOR OF IRON METABOLISM
- 2--ABOUT 1.5 TIMES AMOUNT NEEDED FOR RENEWAL OF RED CELL IRON
- 3--INCREASED IN POLYCYTHEMIA, LEUKEMIA AND ANEMIA
- 4--REDUCED IN POLYCYTHEMIA BY RADIOISOTOPE THERAPY

USAEC-ID 90A

**ILLUSTRATIONS OF ISOTOPE APPLICATIONS
IN BIOLOGY AND MEDICINE, DIAGNOSIS**

RADIOACTIVE SODIUM Na 24

FOR DIAGNOSIS OF PUMPING QUALITIES OF HEART - RADIOCARDIOGRAPHY

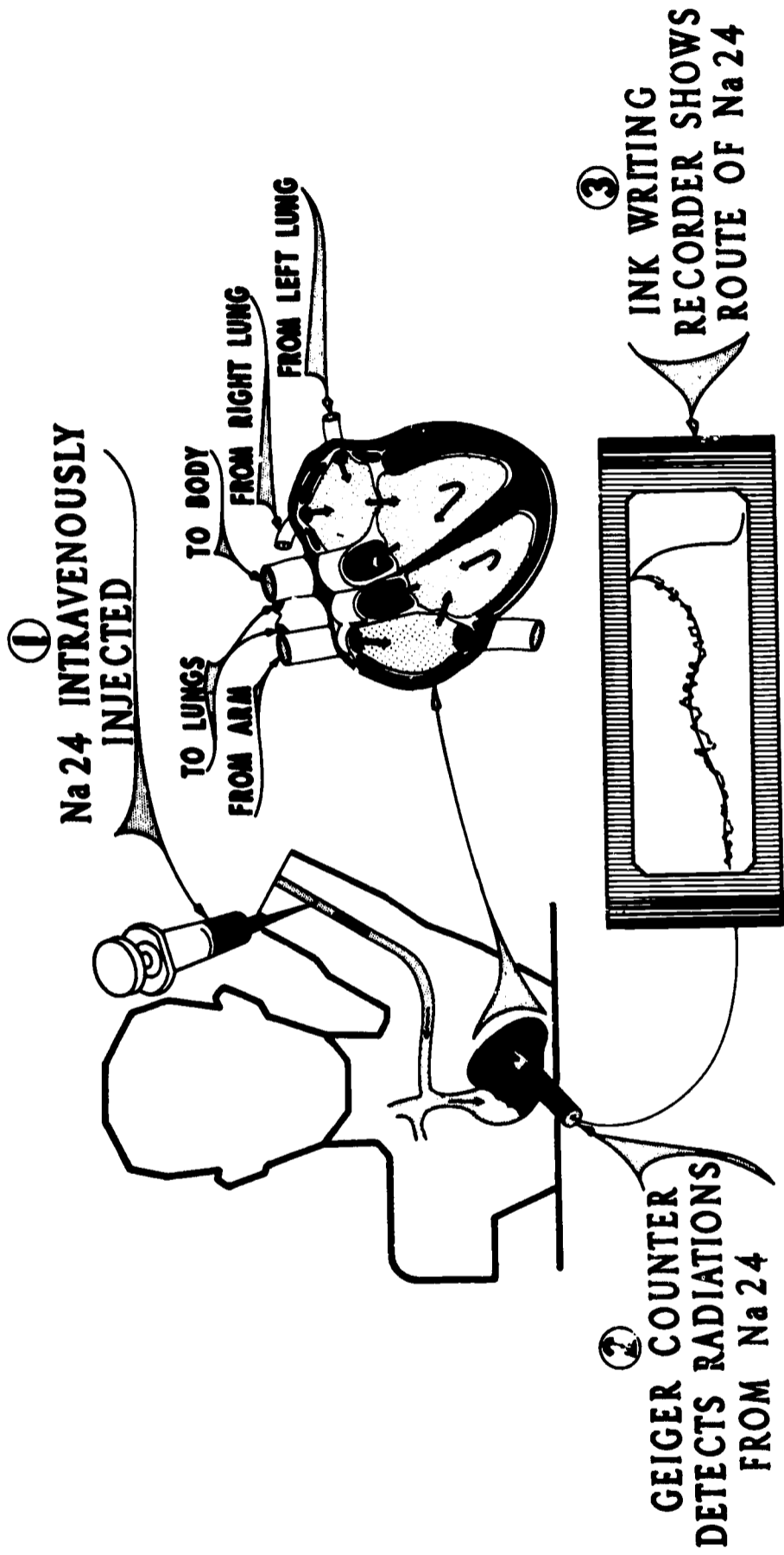

ADVANTAGES:

- 1- GIVES INFORMATION NOT OBTAINABLE BY OTHER MEANS**
- 2- RAPIDITY OF DIAGNOSIS - 1 TO 2 MINUTES**
- 3- RADIOISOTOPE RAPIDLY ELIMINATED FROM BODY**
- 4- NO DISCOMFORT TO PATIENT**

USAEC-1D-164

RADIOACTIVE IODINE - I-131 FOR DETERMINING BLOOD PLASMA VOLUME

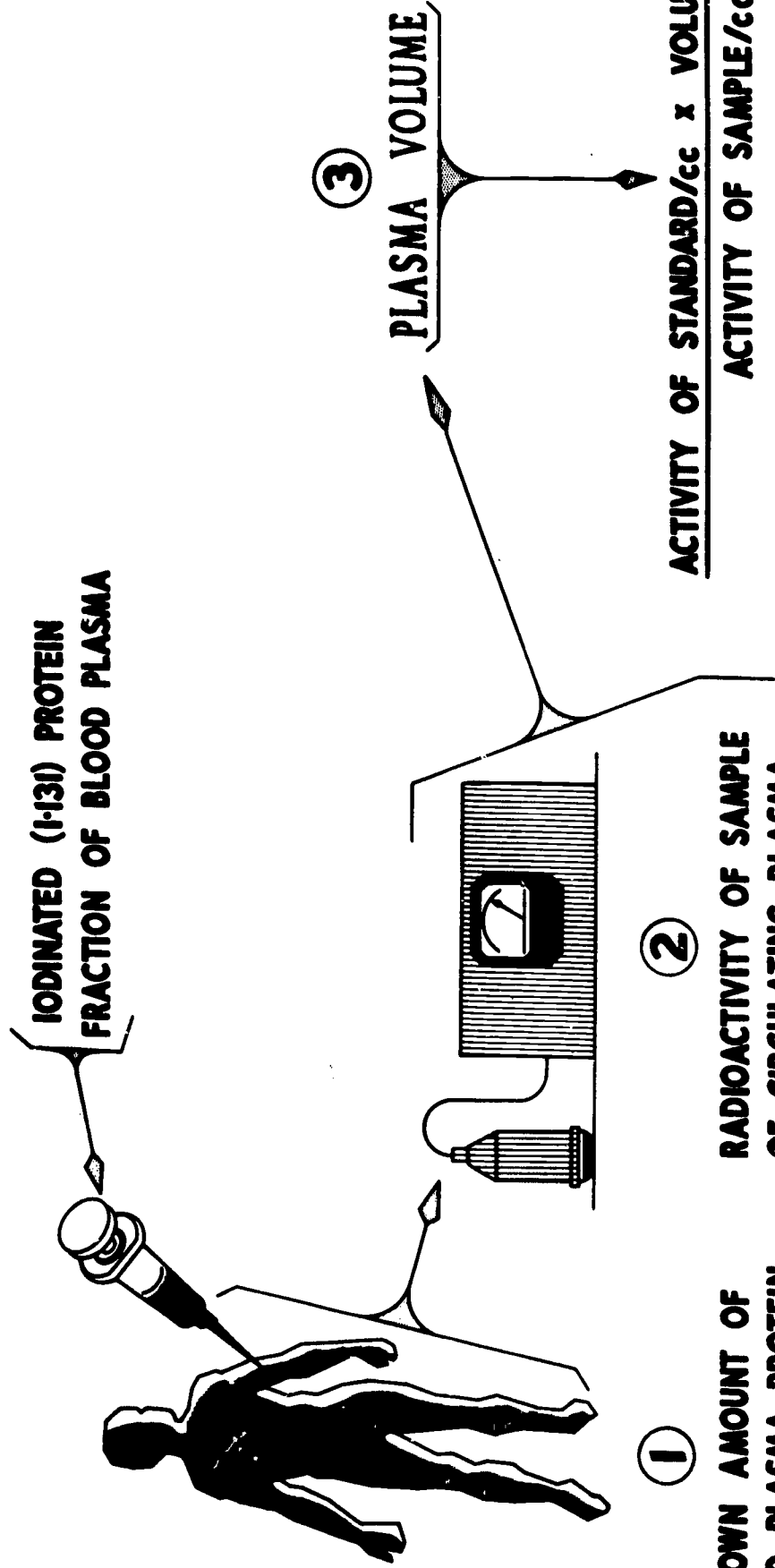

1 - KNOWN AMOUNT OF
Labeled PLASMA PROTEIN
INTRAVENOUSLY INJECTED

2 - RADIOACTIVITY OF SAMPLE
OF CIRCULATING PLASMA
COMPARED WITH STANDARD

3 - $\frac{\text{ACTIVITY OF STANDARD/cc} \times \text{VOLUME INJECTED}}{\text{ACTIVITY OF SAMPLE/cc}}$

ADVANTAGES:

- 1 - PERMITS ACCURATE PLASMA VOLUME DETERMINATIONS FOR COMPARATIVELY LONG PERIODS
- 2 - USED WITH HEMATOCRIT DETERMINATION GIVES QUICK AND ACCURATE BLOOD VOLUME
- 3 - PERMITS FOLLOWING RAPID CHANGES IN CIRCULATING BLOOD VOLUME

USAEC-1D-303

RADIOISOTOPES FOR DIAGNOSIS

**ISOTOPE INDICATES
FLUID SPACE OR FLOW**

BLOOD VOLUME

BLOOD CIRCULATION TO EXTREMITIES

RADIOCARDIOGRAPHY

**ISOTOPE CONCENTRATED
BY SPECIFIC TISSUE**

PHYSIOLOGICAL ACTIVITY OF THYROID

PRE-OPERATIVE LOCALIZATION OF BRAIN TUMOR

DETERMINATION OF EXTENT OF BRAIN TUMOR

USAEC-1D-333

SCREENING TEST FOR HYPERTHYROIDISM

1 HOUR VERSUS 24 HOUR TEST

(UNIVERSITY OF VIRGINIA)

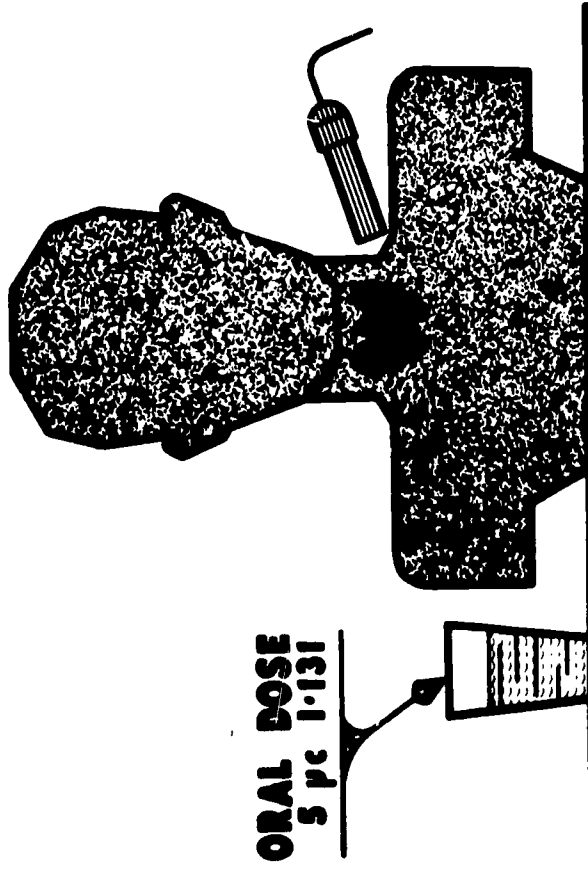
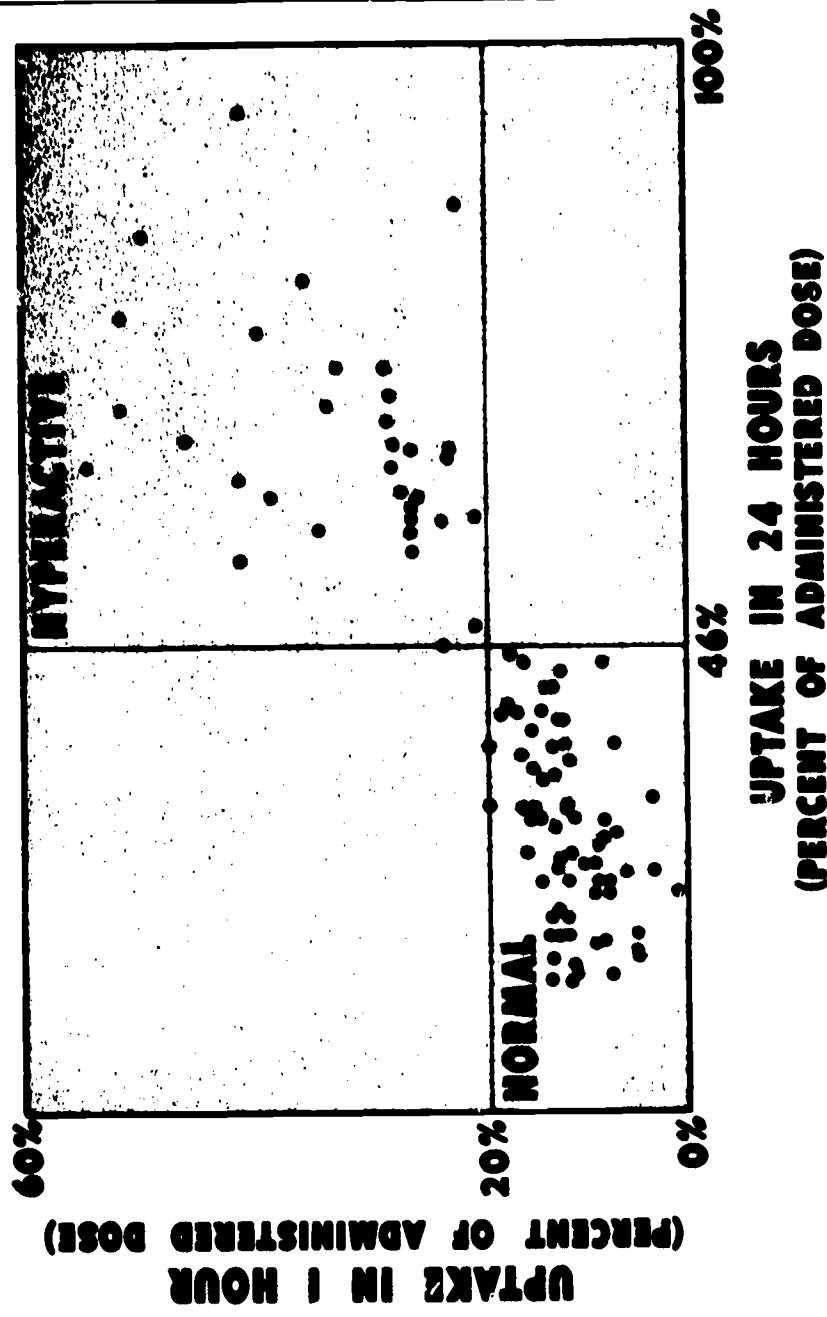

RESULTS:

- 1 - SCREENS HYPERTHYROID FROM NORMAL
- 2 - SAME DIAGNOSIS AT 1 HR. AND 24 HRS. ON 126 OF 130 PATIENTS
- 3 - TESTS CLINICALLY CONFIRMED

USAEC-ID-153A

WHOLE BODY SCANNING

WITH THE AID OF
RADIOISOTOPES

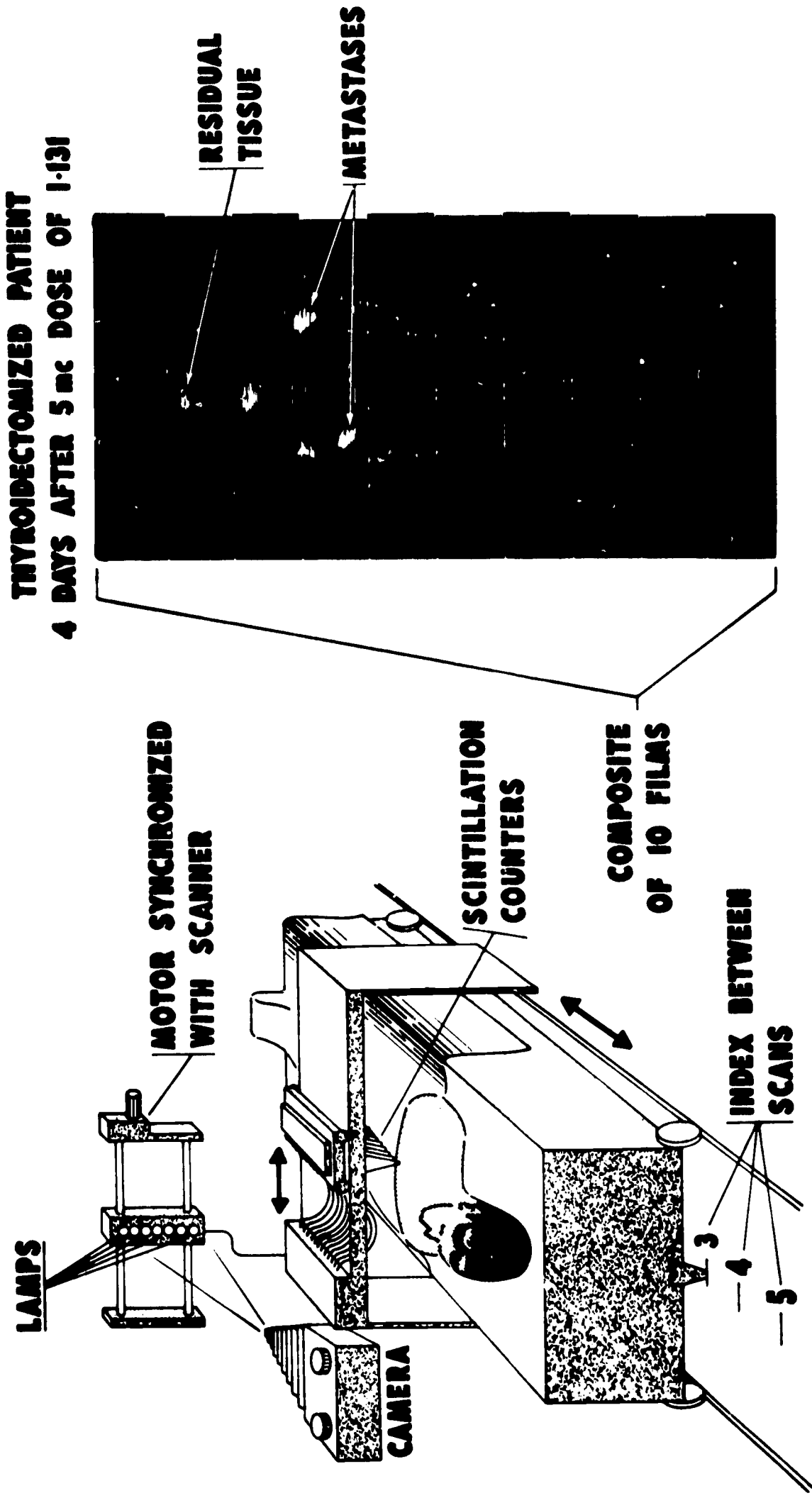

- USES:**
- 1--MAPS RADIOACTIVITY LOCALIZED IN TISSUES
 - 2--LOCATES UNSUSPECTED METASTASES
 - 3--REVEALS RESIDUAL TISSUE AFTER OPERATION

CARDIAC OUTPUT

USING
I-131 LABELED HUMAN SERUM ALBUMIN

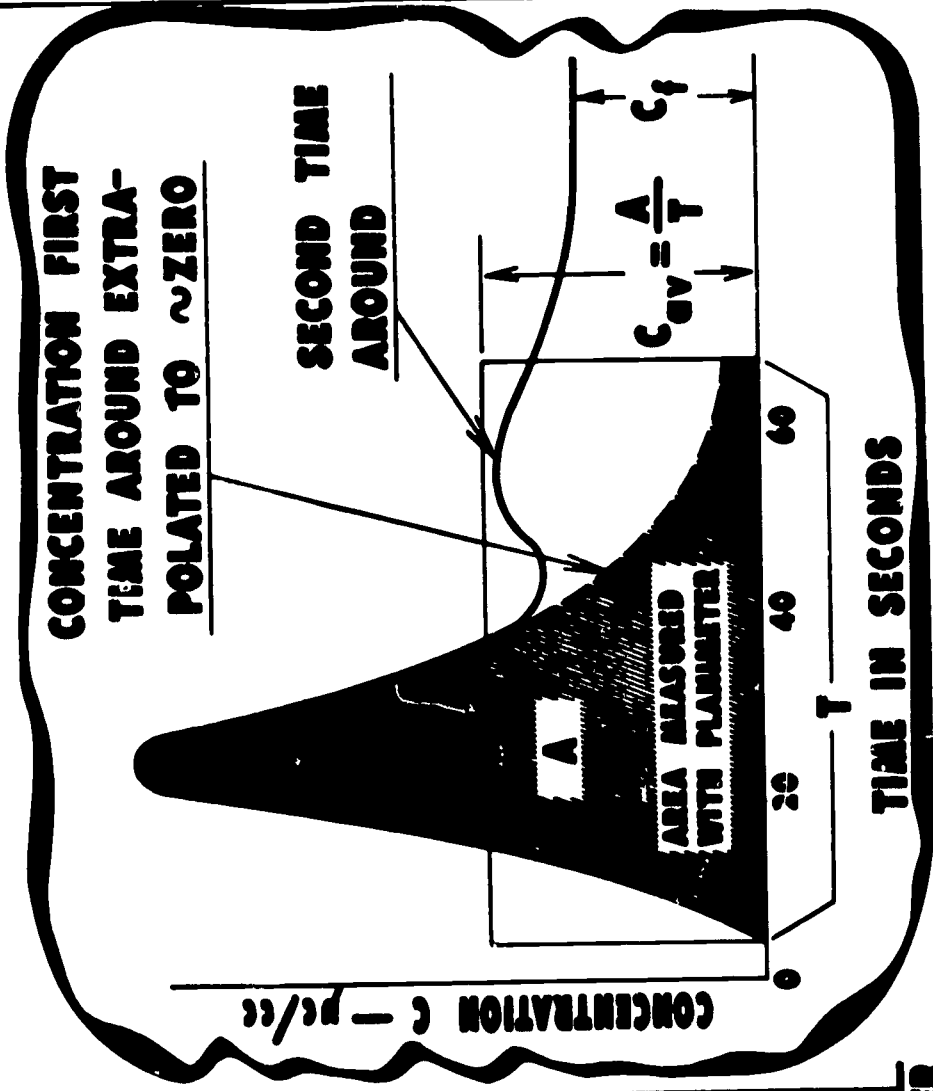
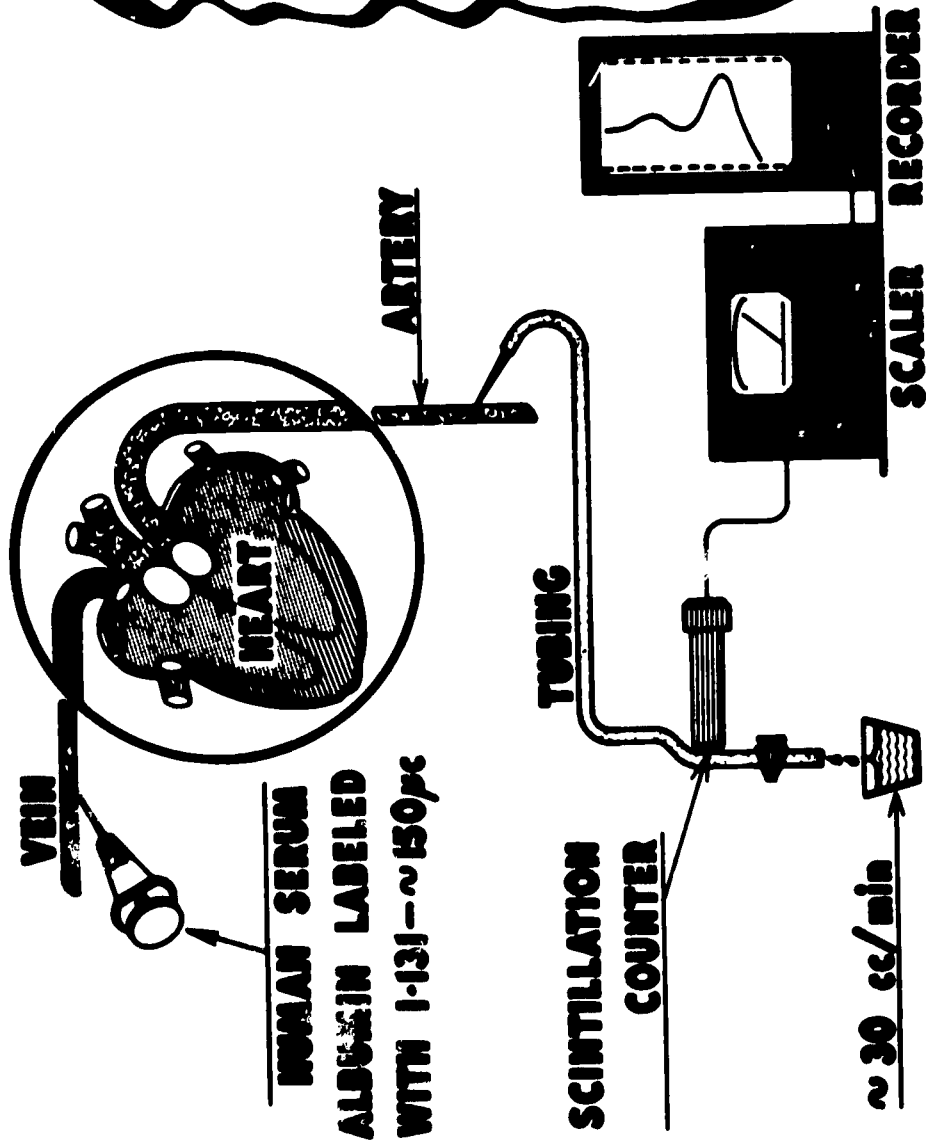

INJECTED ACTIVITY = HEART OUTPUT DURING $T \times C_{cv}$ = TOTAL BLOOD VOLUME $\times C_f$

$$\text{FLOW RATE} \times T \times C_{cv} = V \times C_f$$

$$\text{FLOW RATE} = \frac{C_f}{C_{cv}} \times \frac{V}{T} \text{ liters/min}$$

CHIEF CLINICAL USES OF RADIOISOTOPES

USING INSTITUTIONS

USE DIAGNOSIS

ISOTOPE

I-131	THYROID FUNCTION (DIAGNOSIS ONLY) BLOOD VOLUME, CIRCULATION, ETC. TUMOR DETECTION (BRAIN, LIVER, ETC.)	80 111 95
P 32	BLOOD VOLUME, CIRCULATION, ETC. TUMOR DETECTION	37 39

TREATMENT

I-131	HYPERTHYROIDISM AND HEART DISORDERS CANCER	291 242
P 32	POLYCYTHEMIA AND LEUKEMIA CANCER	269 87
Au 198	INTRACAVITARY PROSTATE OTHER INTERSTITIAL	131 32 43

USAEC-ID-204A

Uptake in Spleen

USING

RADIOACTIVE IRON

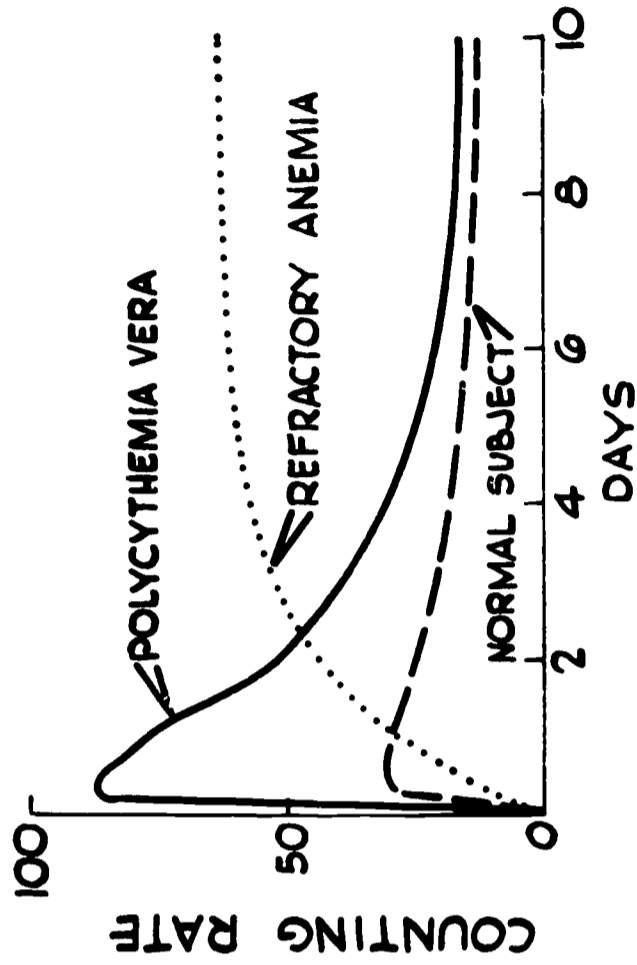
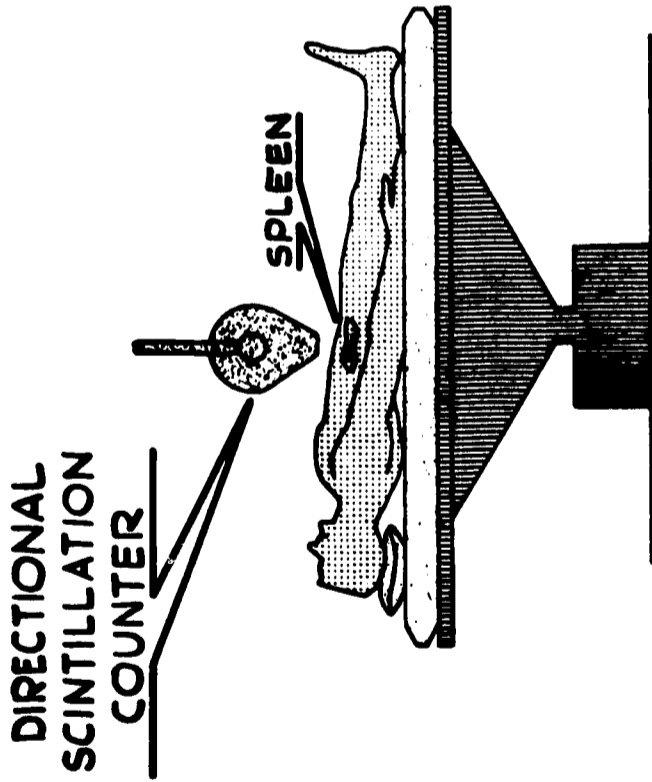

POLYCYTHEMIA VERA — INCREASED RED-CELL PRODUCTION IN SPLEEN
REFRACTORY ANEMIA — SPLEEN DESTROYS RED-CELLS AT ABNORMAL RATE
NORMAL SUBJECT — BALANCE OF PRODUCTION AND DESTRUCTION

USAEC-10-278A

Detection of Arteriosclerosis

USING

TRITIUM-LABELED CHOLESTEROL

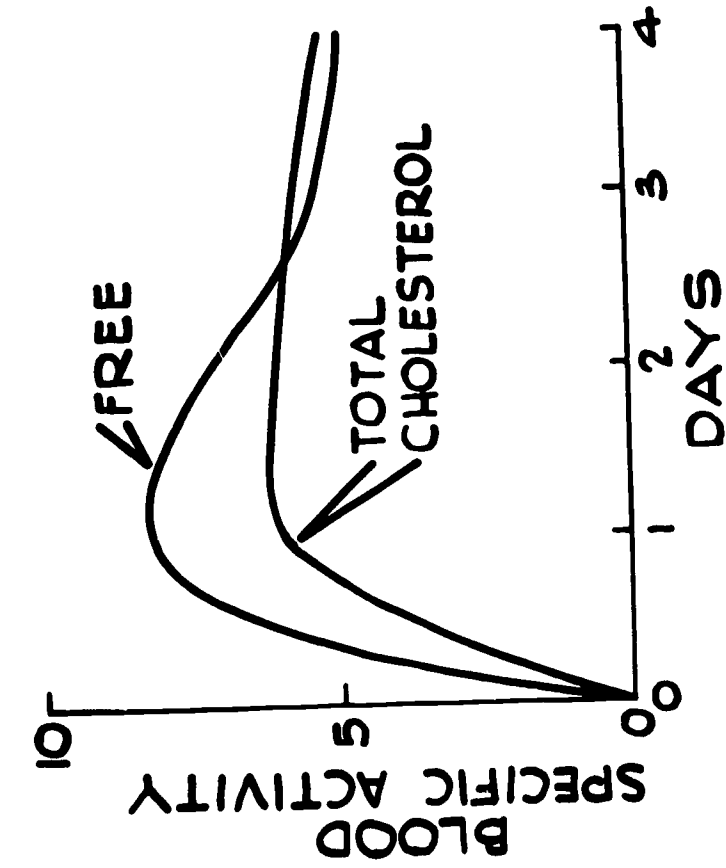

NORMAL SUBJECT

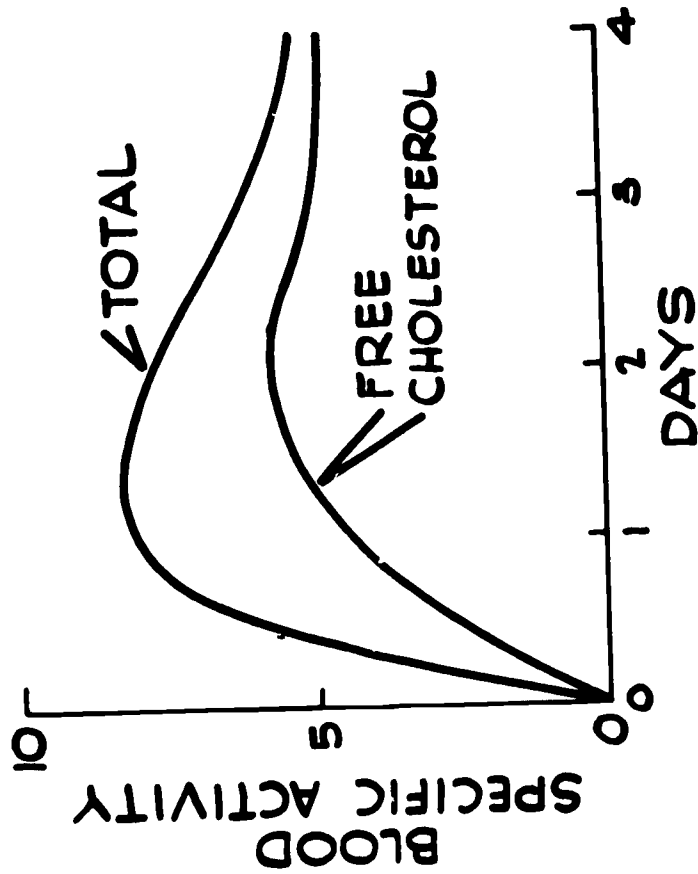

PATIENT WITH ARTERIOSCLEROSIS

- .. CONSTANT FINDING BETWEEN NORMAL AND DISEASED MAN.
- .. TEST MAY LEAD TO EARLY DIAGNOSIS OF A TENDENCY TOWARD ARTERIOSCLEROSIS.

USAEC-ID-281A

LOCATING BRAIN TUMORS

WITH
I-131-TAGGED HUMAN SERUM ALBUMIN

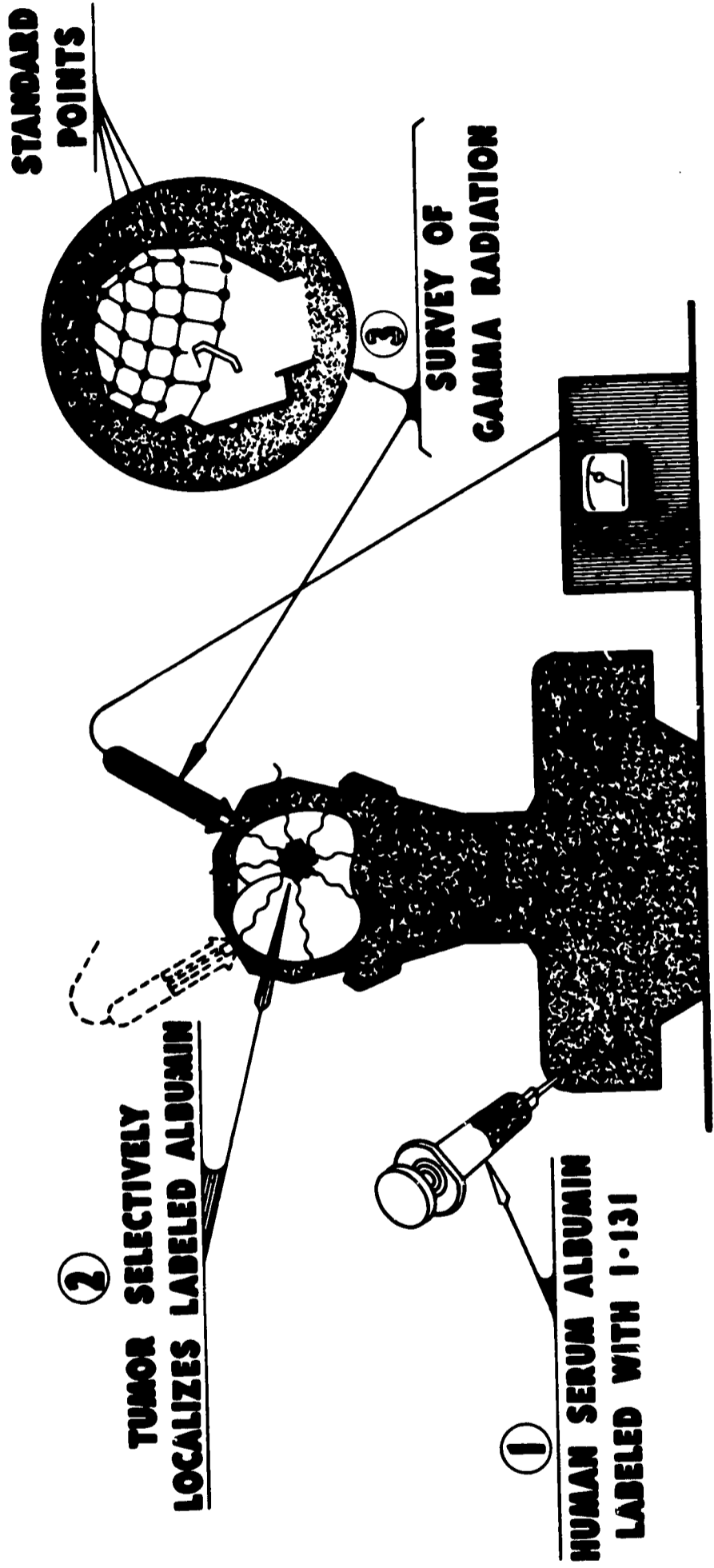

AID TO DIAGNOSIS PRIOR TO SURGERY
LOCATES TUMORS NOT FOUND BY OTHER MEANS
CAN USE MULTIPLE COUNTERS FIXED IN STANDARD POSITIONS

USAEC-ID-154A

RADIOACTIVE SODIUM - Na 24
FOR DETECTING NORMAL AND RESTRICTED BLOOD CIRCULATION

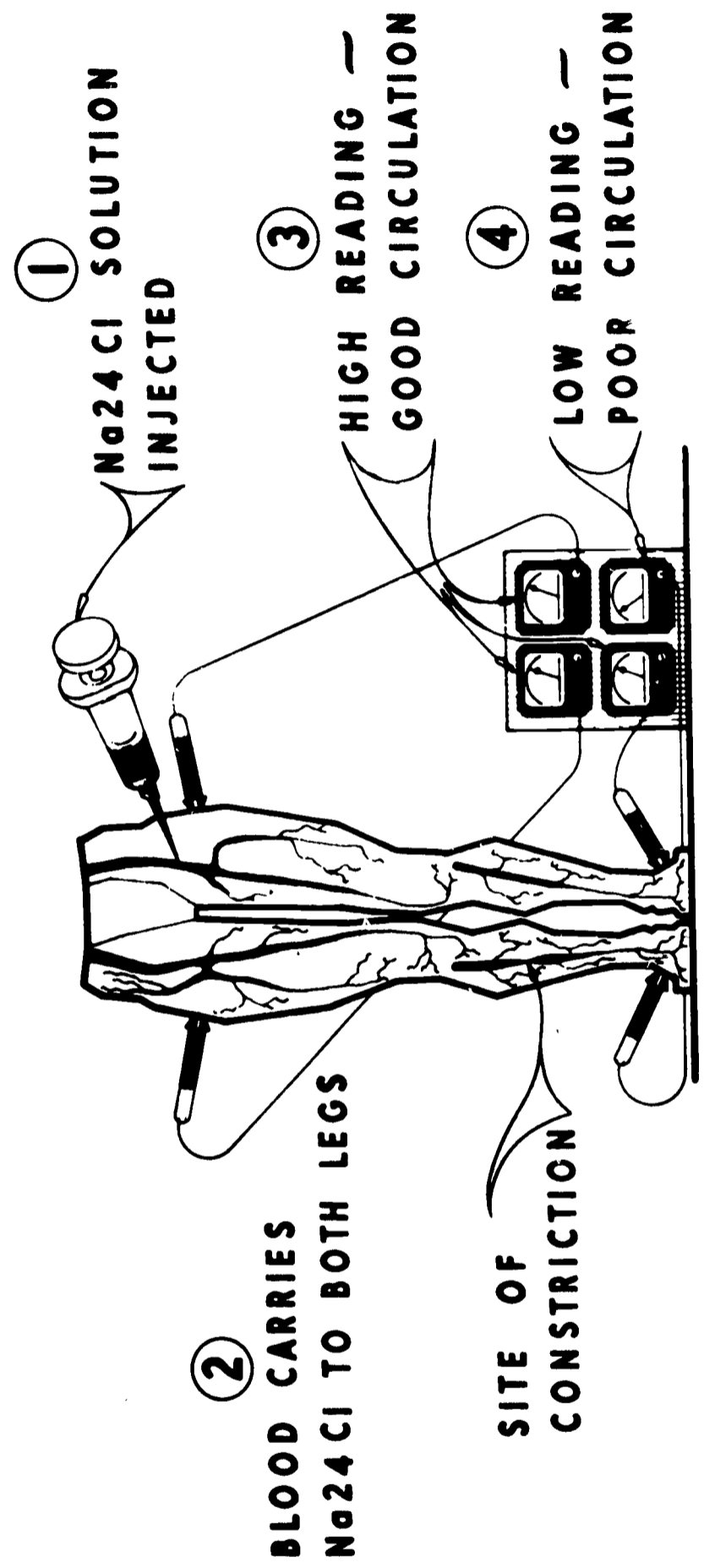

ADVANTAGES:

- 1- GIVES PATTERN OF BLOOD FLOW**
- 2- PERMITS EXACT LOCATION OF ARTERIAL CONSTRICTION**
- 3- METHOD QUICK AND NO DISCOMFORT TO PATIENT**

1D-USAEC

**ILLUSTRATIONS OF ISOTOPE APPLICATIONS
IN BIOLOGY AND MEDICINE, THERAPY**

RADIOACTIVE PHOSPHORUS - P 32

FOR TREATMENT OF: A-POLYCYTHEMIA VERA
B-CHRONIC LEUKEMIA

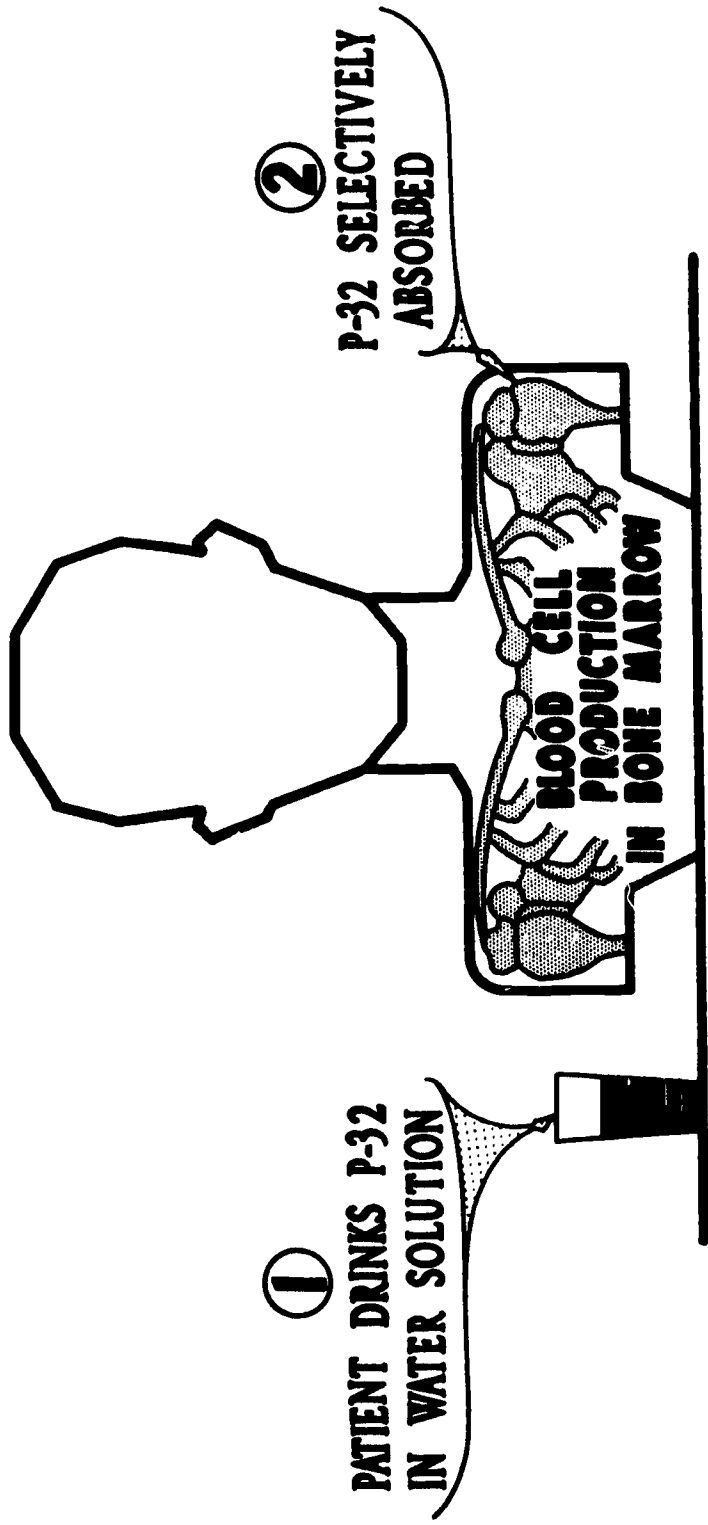

THERAPEUTIC ACTION:

- 1 - PARTIALLY SELECTIVE UPTAKE
- 2 - SLOW PROTRACTED IRRADIATION
- 3 - INHIBITS BLOOD CELL PRODUCTION

USAEC-1D-191

RADIOACTIVE STRONTIUM - Sr 90

FOR TREATING SMALL LESIONS

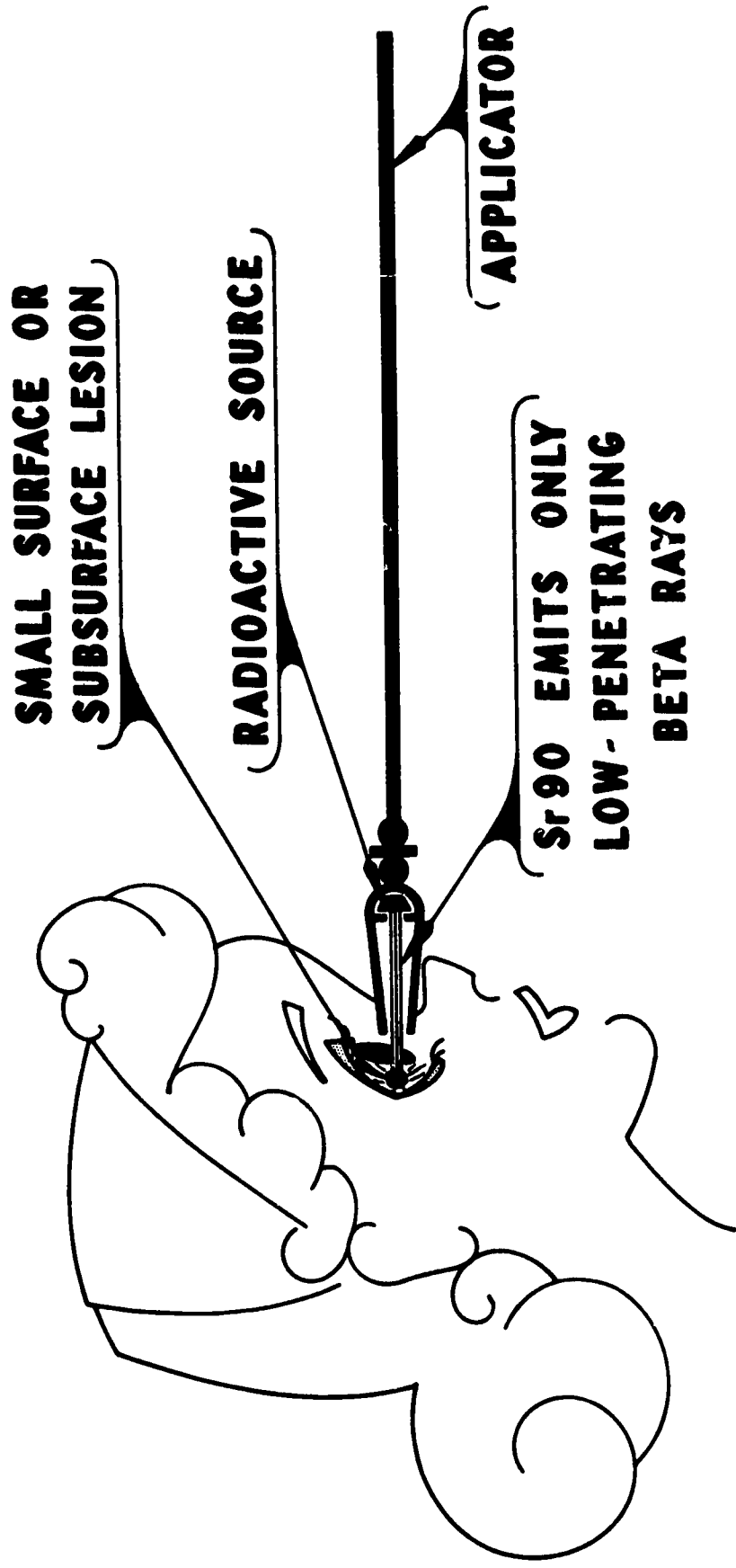

ADVANTAGES:

- 1 - NO EXTRANEOUS GAMMA RADIATION**
- 2 - REMOVAL OF BENIGN TUMORS WITHOUT SURGERY**
- 3 - READILY ADAPTABLE TO THERAPY OF POSTOPERATIVE LESIONS**

USAEC-1D-200

RADIOACTIVE COBALT - Co 60 FOR EXTERNAL GAMMA RAY TREATMENT

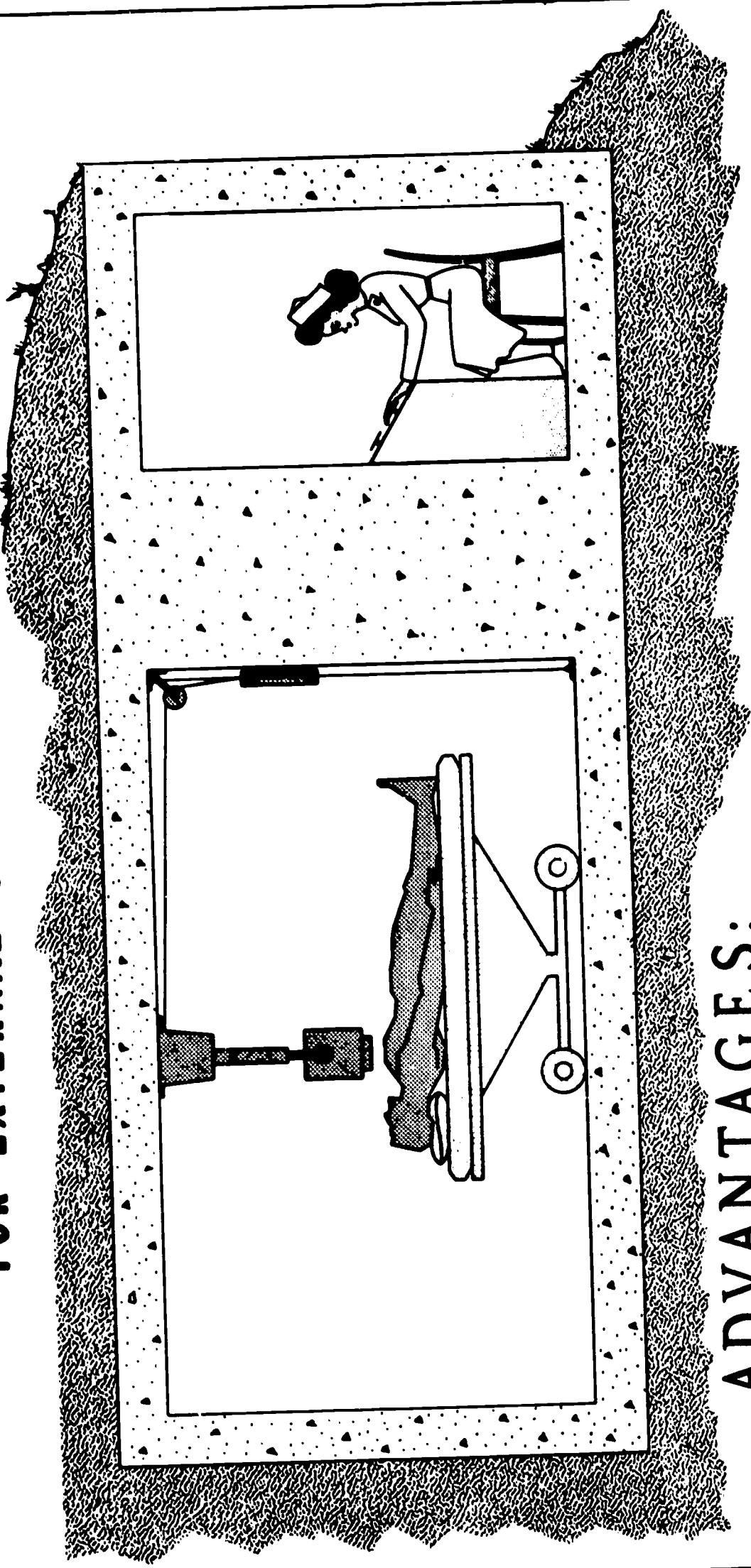

ADVANTAGES:

- 1- HIGHLY PENETRATING RADIATION**
- 2- RADIATION ENERGY NEARLY UNIFORM**
- 3- INEXPENSIVE TO PRODUCE**

USAEC-ID-306

ADVANTAGES OF RADIOCOBALT FOR INTERSTITIAL TREATMENT

- - - - -

PERMITS TECHNIQUES BASED ON:

A. THIN WALL TUBING TO REMOVE BETA RAYS

- 1 - STAINLESS STEEL - - 0.1 mm.**
- 2 - ALUMINUM - - 0.3 mm.**
- 3 - NYLON - - 0.7 mm.**

B. LARGE INVENTORY OF RADIOCOBALT

- 1 - AVAILABLE IN LARGE QUANTITIES AT LOW COST**
- 2 - AVAILABLE IN WIDE RANGE OF ACTIVITIES PER GRAM**
- 3 - SPECIAL APPLICATORS STOCKED FOR VARIETY OF CASE TYPES**

C. NEEDLES AND SHEATHS EASILY TAILORED FOR EACH CASE

- 1 - TUBING EASILY LOADED AND SHAPED**
- 2 - DISTRIBUTION OF ACTIVITY VARIED AS DESIRED**
- 3 - COBALT READILY RECOVERED - - TUBING EXPENDABLE**

GAMMA RAY TELE THERAPY UNIT

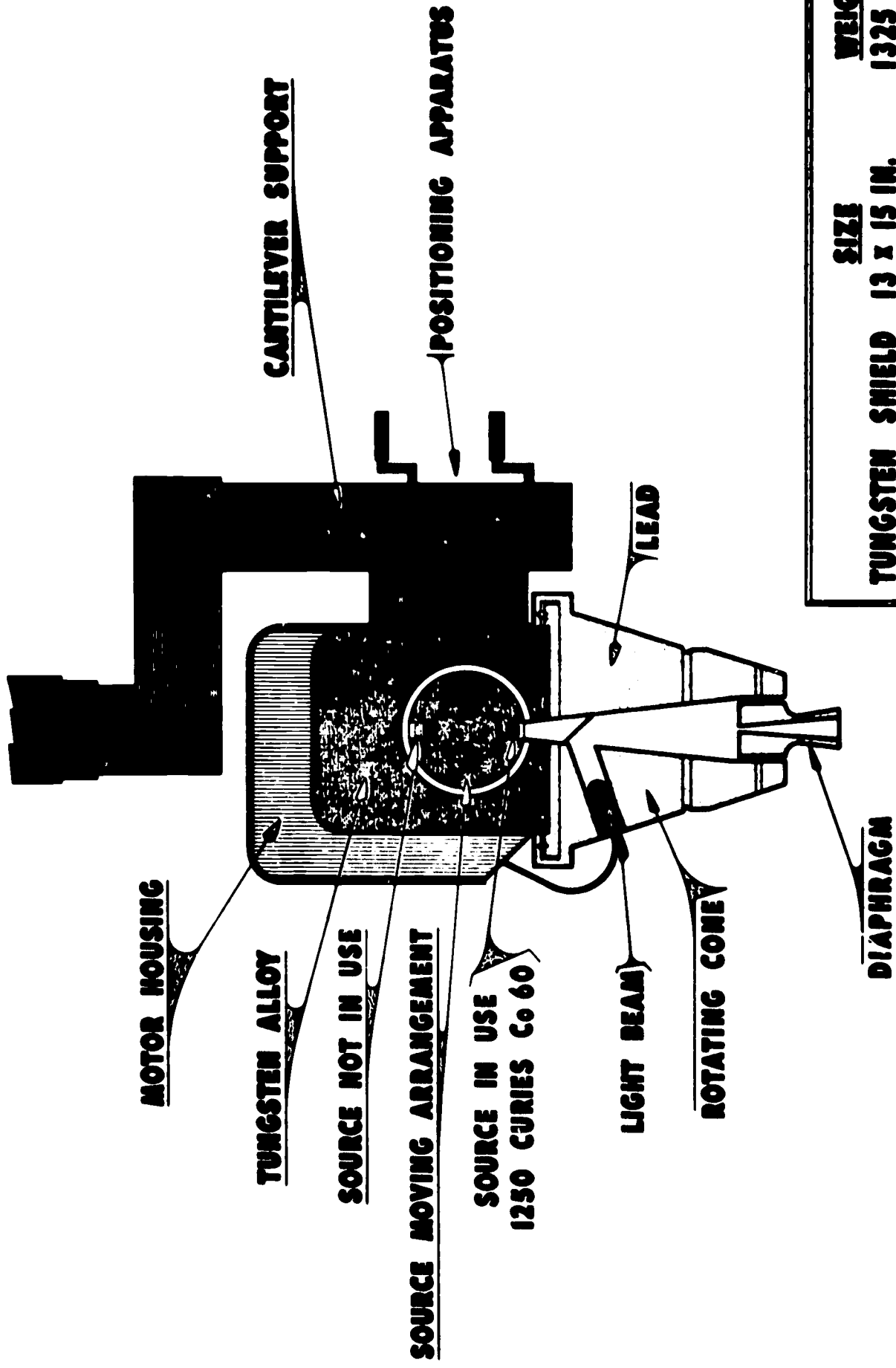

	<u>SIZE</u>	<u>WEIGHT</u>
TUNGSTEN SHIELD	13 x 15 IN.	1325 LBS.
CONE	13 x 15 IN.	300 LBS.
DIAPHRAGMS	15 x 15 cm MAX.	25-50 LBS.

THERAPY METHODS WITH RADIOISOTOPES

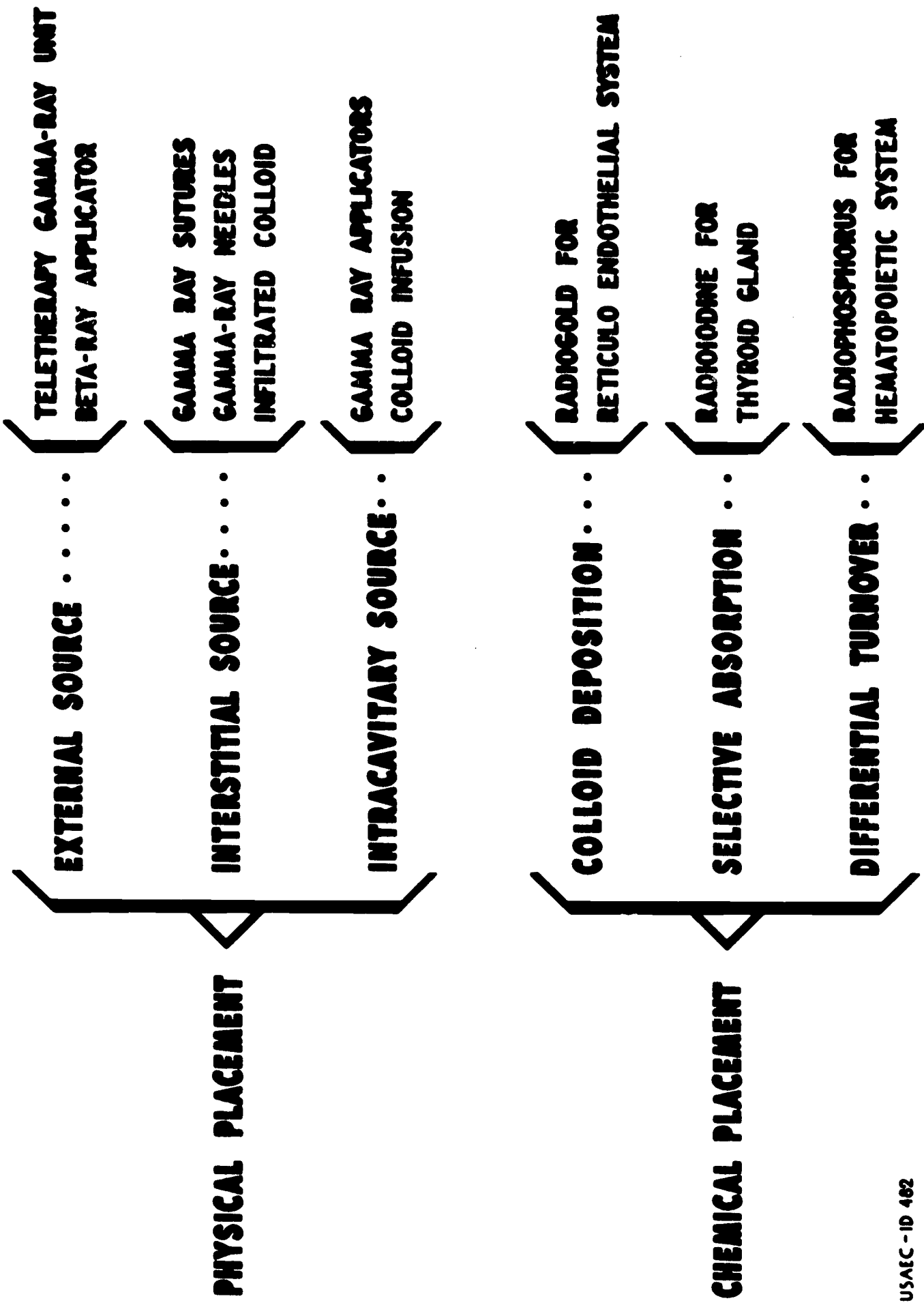

USAEC - ID 462

METHOD FOR INTRACAVITARY INFUSION OF RADIOGOLD COLLOID

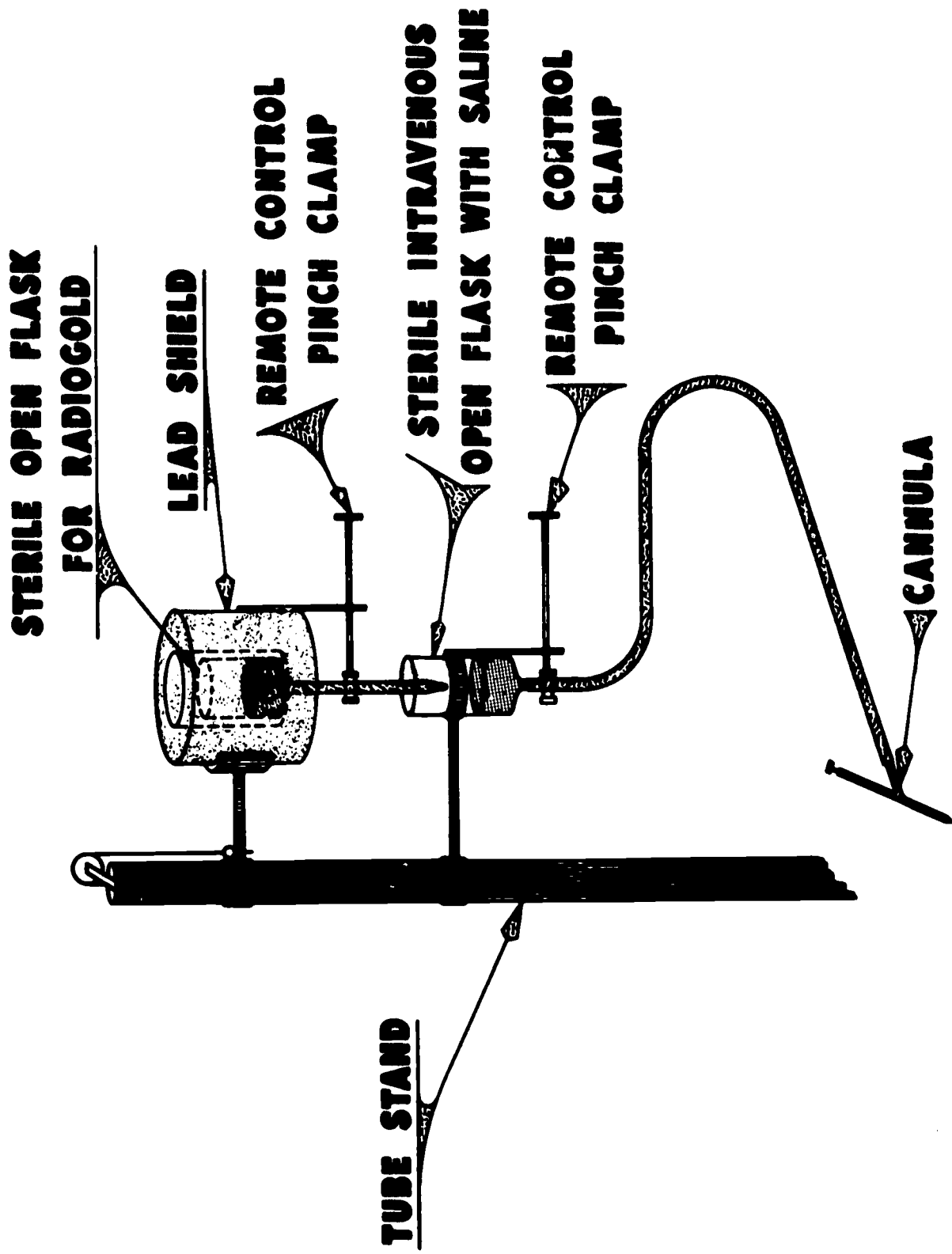

USAEC - ID 467

RADIOACTIVE GOLD - Au 198

FOR INTRACAVITARY USE IN METASTASIZED CANCER

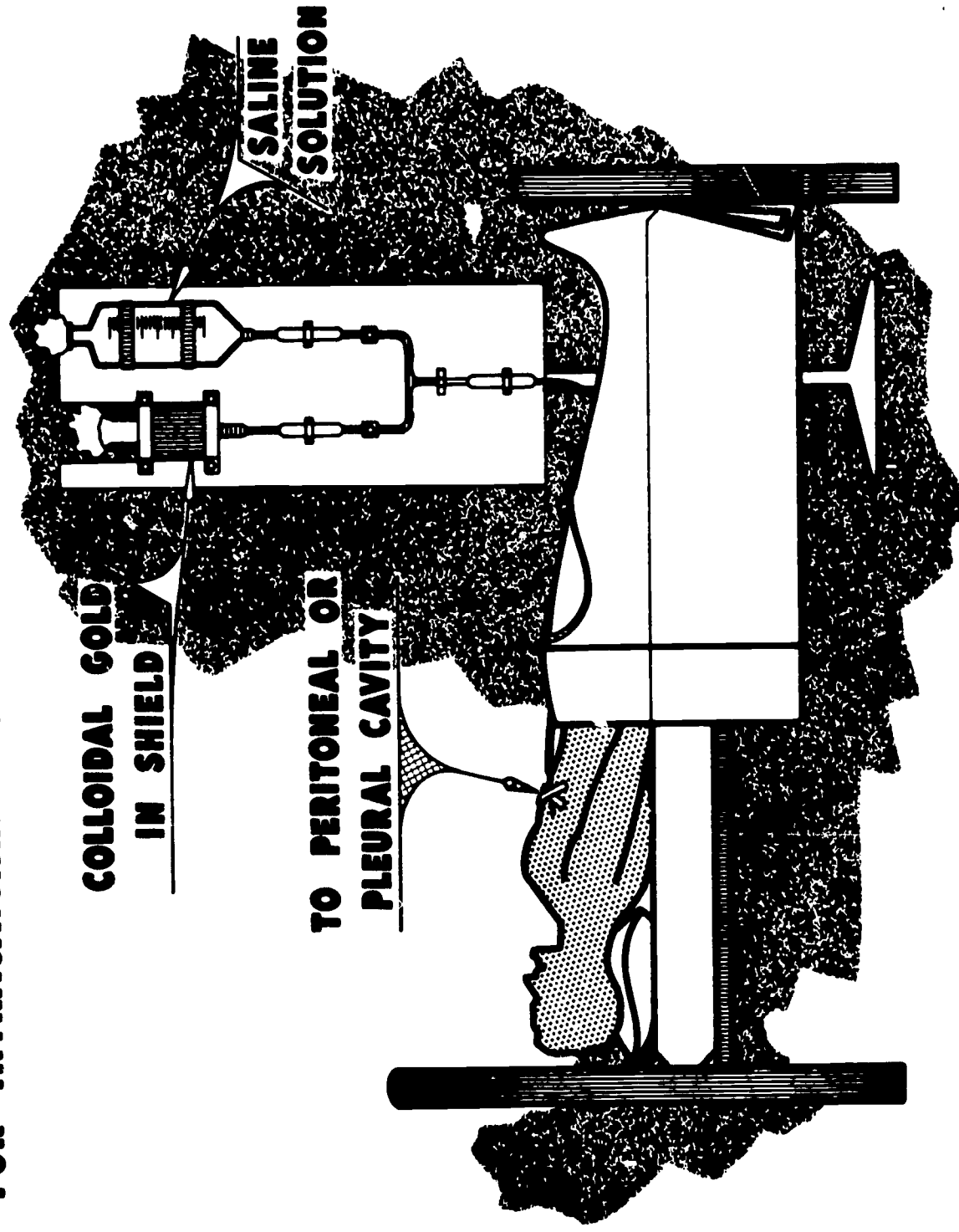

- ### **ADVANTAGES:**
- 1 - INHIBITS FORMATION OF CAVITARY FLUID**
 - 2 - REDUCES PAIN**
 - 3 - HELPS RETURN PATIENT TO NORMAL ACTIVITY**

USAEC-ID-18A

LOCATING BRAIN TUMORS

WITH
I-131-TAGGED HUMAN SERUM ALBUMIN

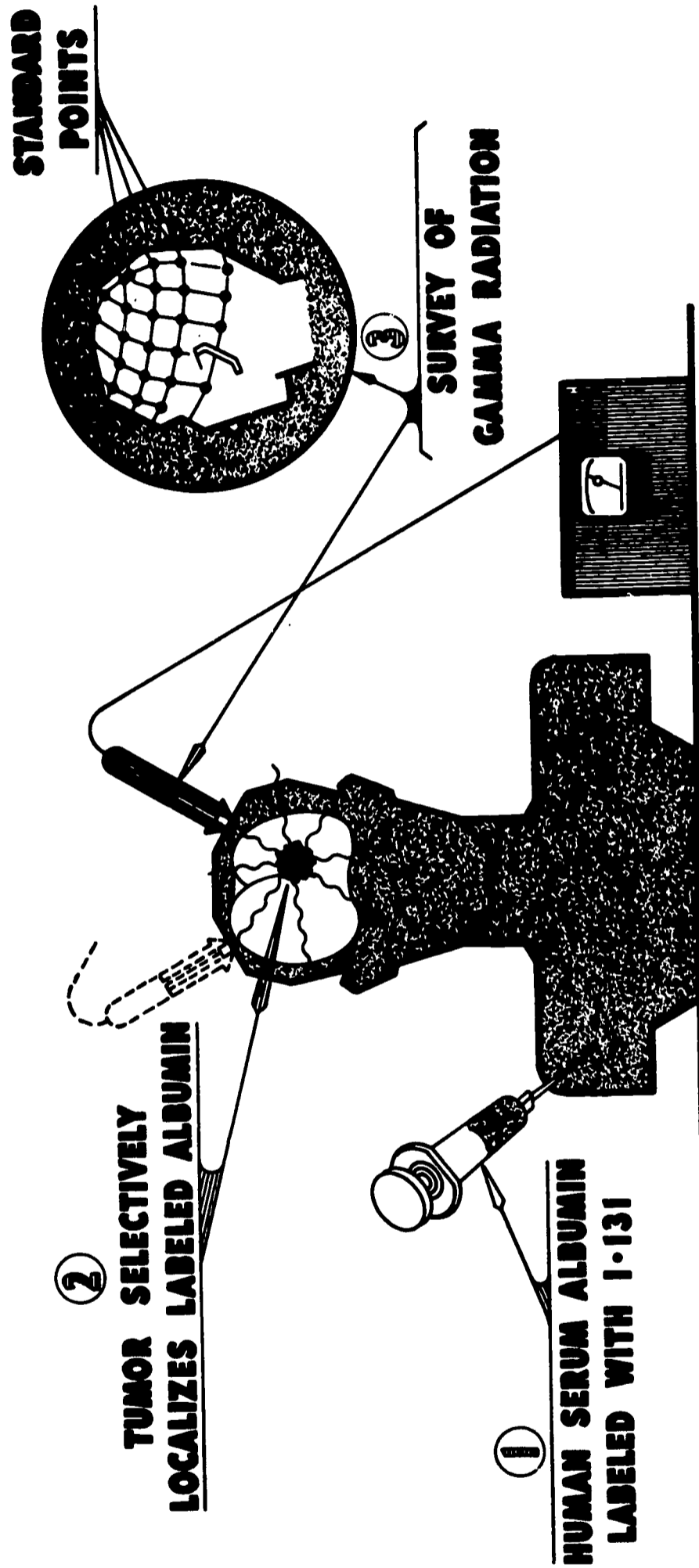

**AID TO DIAGNOSIS PRIOR TO SURGERY
LOCATES TUMORS NOT FOUND BY OTHER MEANS
CAN USE MULTIPLE COUNTERS FIXED IN STANDARD POSITIONS**

USAEC-ID-154A

ROTATIONAL TELEETHERAPY

USING

Co 60 GAMMA RAYS

(FRANCIS DELAFIELD HOSPITAL - NYC)

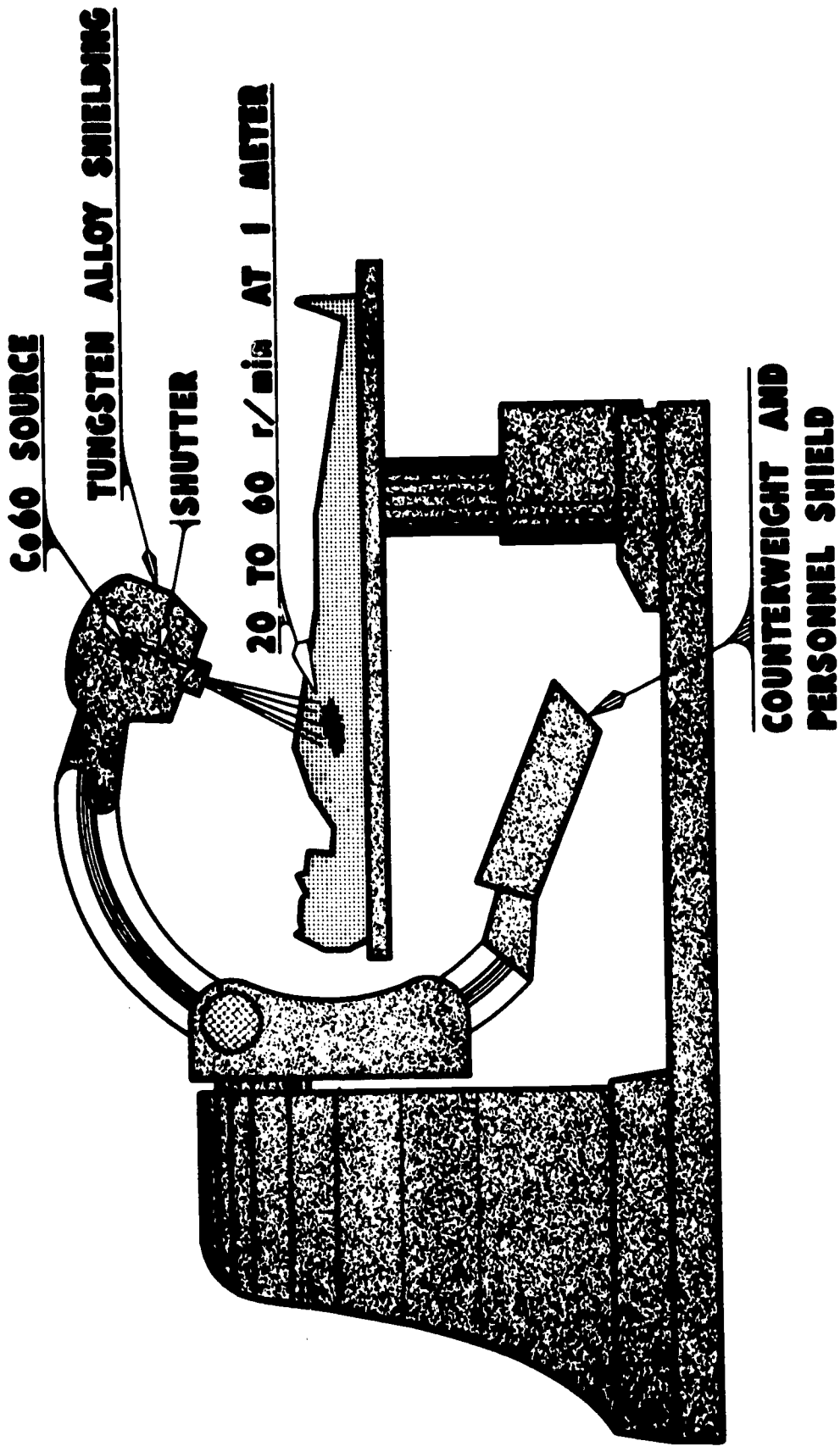

ADVANTAGES:

- 1-EFFECTIVE DOSE AT DEEP-SEATED TUMOR -- SMALL DOSE AT SURFACE
- 2-ALLOWS SELECTION OF IRRADIATION PATTERNS
- 3-ROTATION AND SHUTTER REMOTELY CONTROLLED

USAEC-D-155A

ROTATIONAL TELETHERAPY

USING

Co 60 GAMMA RAYS

"THERATRON" — AECL

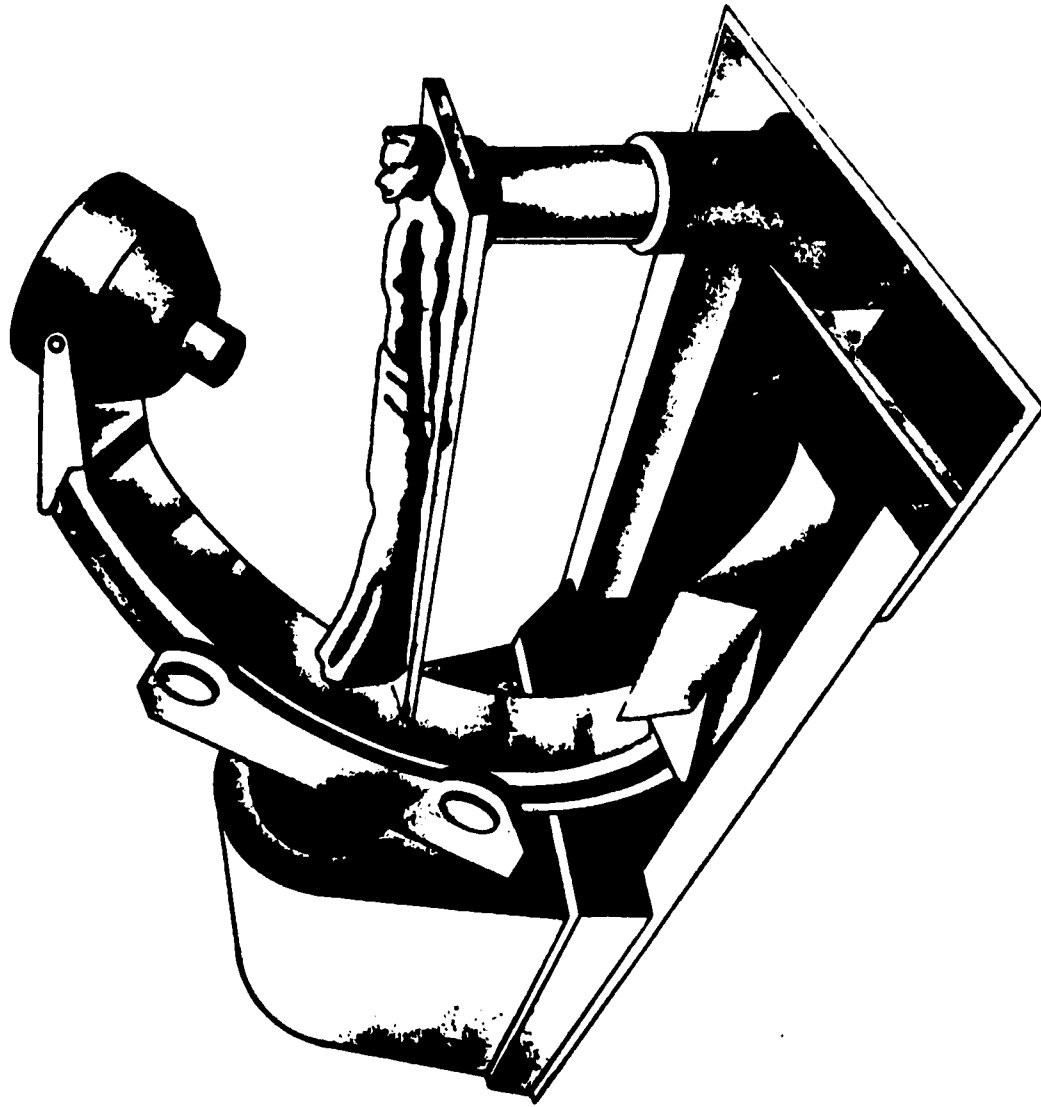

ADVANTAGES:

- 1 - EFFECTIVE DOSE AT DEEP-SEATED TUMOR — SMALL DOSE AT SURFACE**
- 2 - ALLOWS SELECTION OF IRRADIATION PATTERNS**
- 3 - ROTATION AND SHUTTER REMOTELY CONTROLLED**

USAEC-ID-158A

**RADIOACTIVE COBALT - Co 60
FOR INTRACAVITARY OR EXTERNAL APPLICATORS**

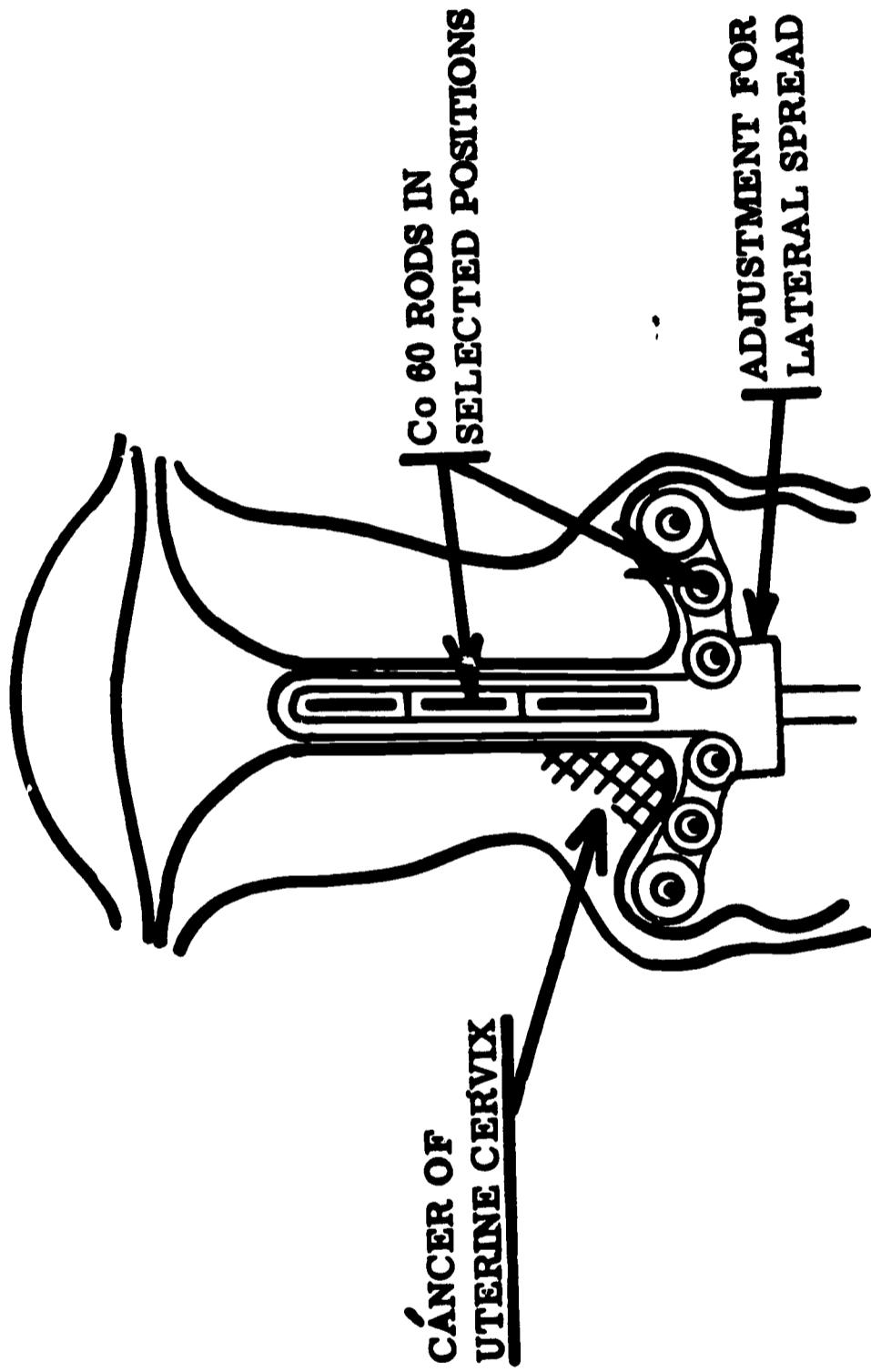

**PERMITS WIDE VARIETY OF APPLICATORS
READILY AVAILABLE AND INEXPENSIVE
ALLOWS LARGE INVENTORY OF SPECIAL SOURCES**

U.S.A.E.C.-1D-235A

Life Expectancy of Polycythemia Vera Patients

AFTER USING

RADIOACTIVE PHOSPHORUS

NO. CASES -----201
 AVERAGE AGE -----52
 MEDIAN SURVIVAL-----13.2
 SURVIVAL FOR:
 5 YEARS-----91.5%
 10 YEARS-----70.0%

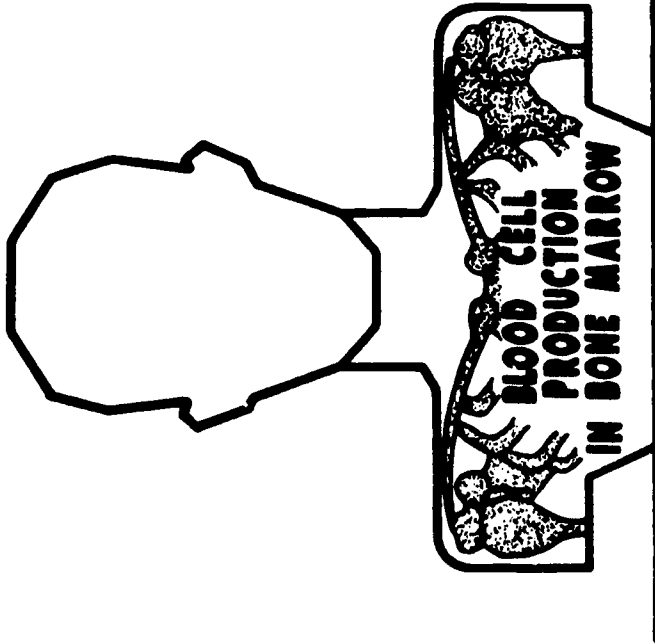
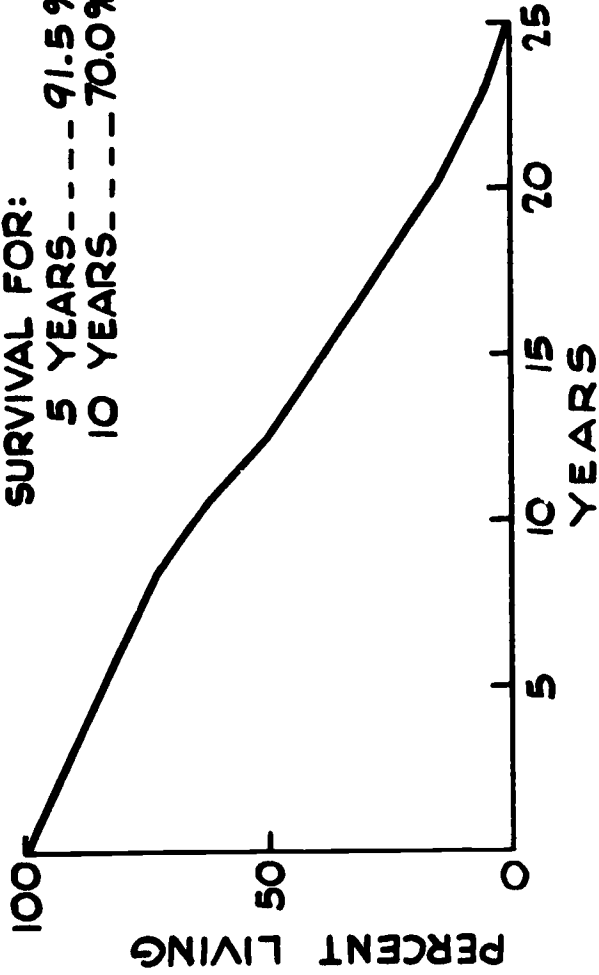

LIFE EXPECTANCY EQUAL TO OR BETTER THAN:
 LIVER EXTRACT IN TREATMENT OF PERNICIOUS ANEMIA
 INSULIN IN DIABETES TREATMENT

USAEC-10-279A

RADIOACTIVE IODINE - I-131

FOR DIAGNOSING AND TREATING THYROID GLAND DISORDERS

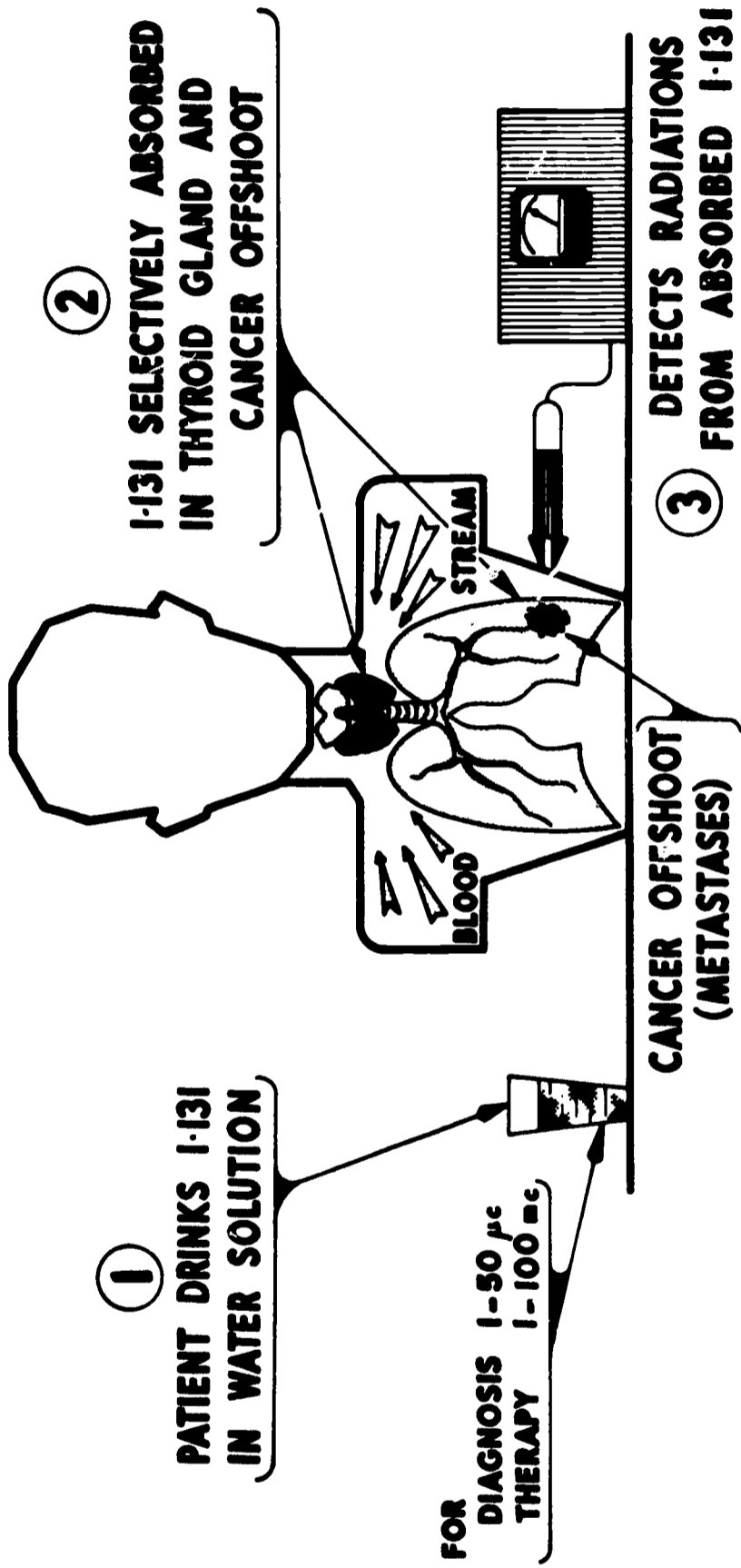

MEDICAL ACTION:

- 1- DIAGNOSIS AND TREATMENT OF HYPERTHYROIDISM
- 2- LOCATION OF THYROID CANCER OFFSHOOTS (METASTASES)
- 3- TREATMENT OF THYROID CANCER AND METASTASES

ID-USAEC

**ILLUSTRATIONS OF ISOTOPE APPLICATIONS
IN AGRICULTURE**

RADIOACTIVE PHOSPHORUS - P 32

FOR STUDY OF PHOSPHATE FERTILIZER UPTAKE

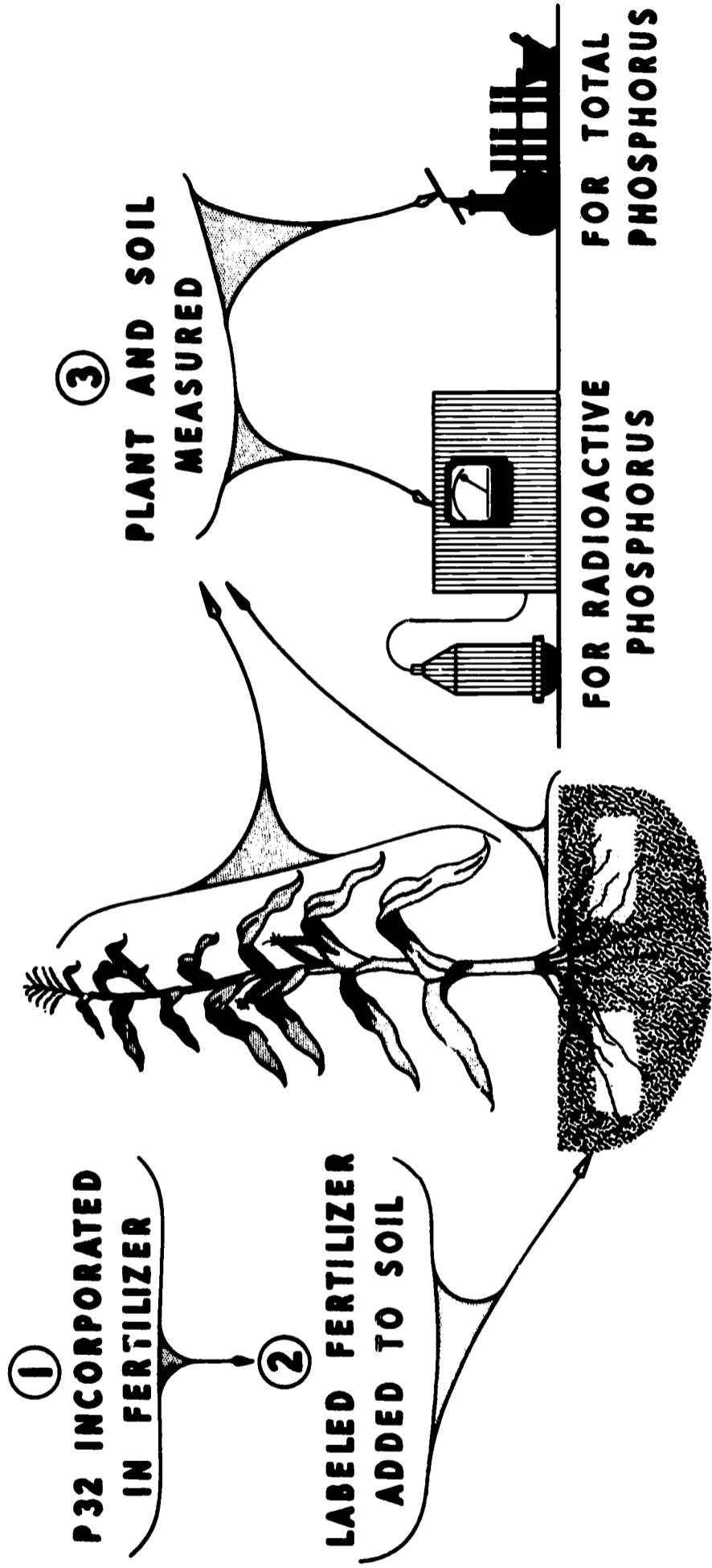

SHOWS:

- 1- FIXATION OF PHOSPHORUS BY SOIL
- 2- PHOSPHORUS UPTAKE BY PLANT
- 3- PROPER TYPE AND PLACEMENT OF FERTILIZER
- 4- EFFICIENCY OF FERTILIZER

USAEC-ID-179

RADIOACTIVE CARBON - C14

FOR STUDYING FOOD PRODUCTION BY PLANTS - PHOTOSYNTHESIS

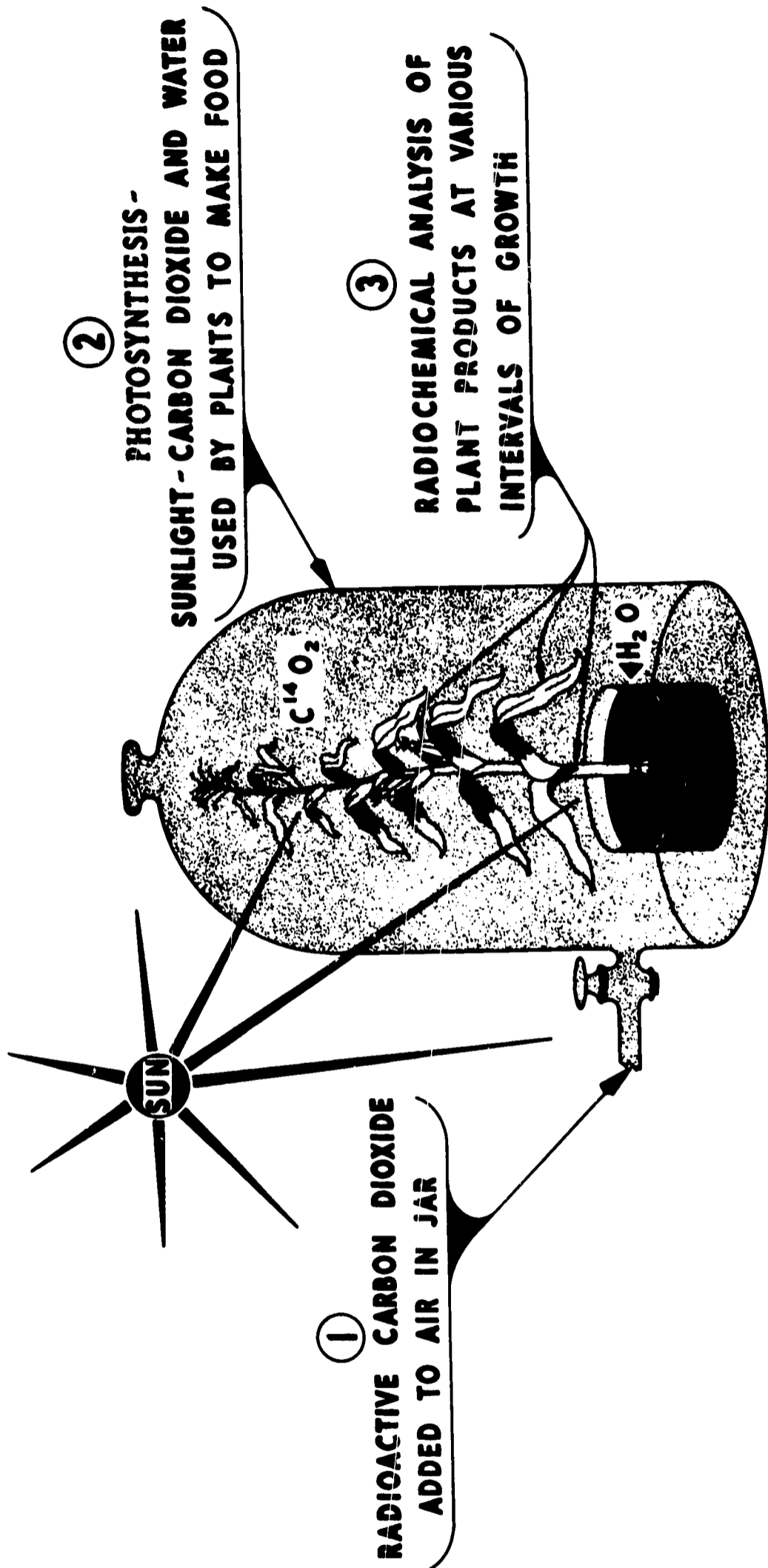

SHOWS:

- 1 - RAPIDITY OF LIFE PROCESSES
- 2 - INTERMEDIATE STEPS IN PRODUCING FOODS
- 3 - ROLE OF CHLOROPHYLL (GREEN PIGMENT)

USAEC-ID-190

RADIOACTIVE CALCIUM - Ca 45

FOR STUDYING PLANT NUTRITION

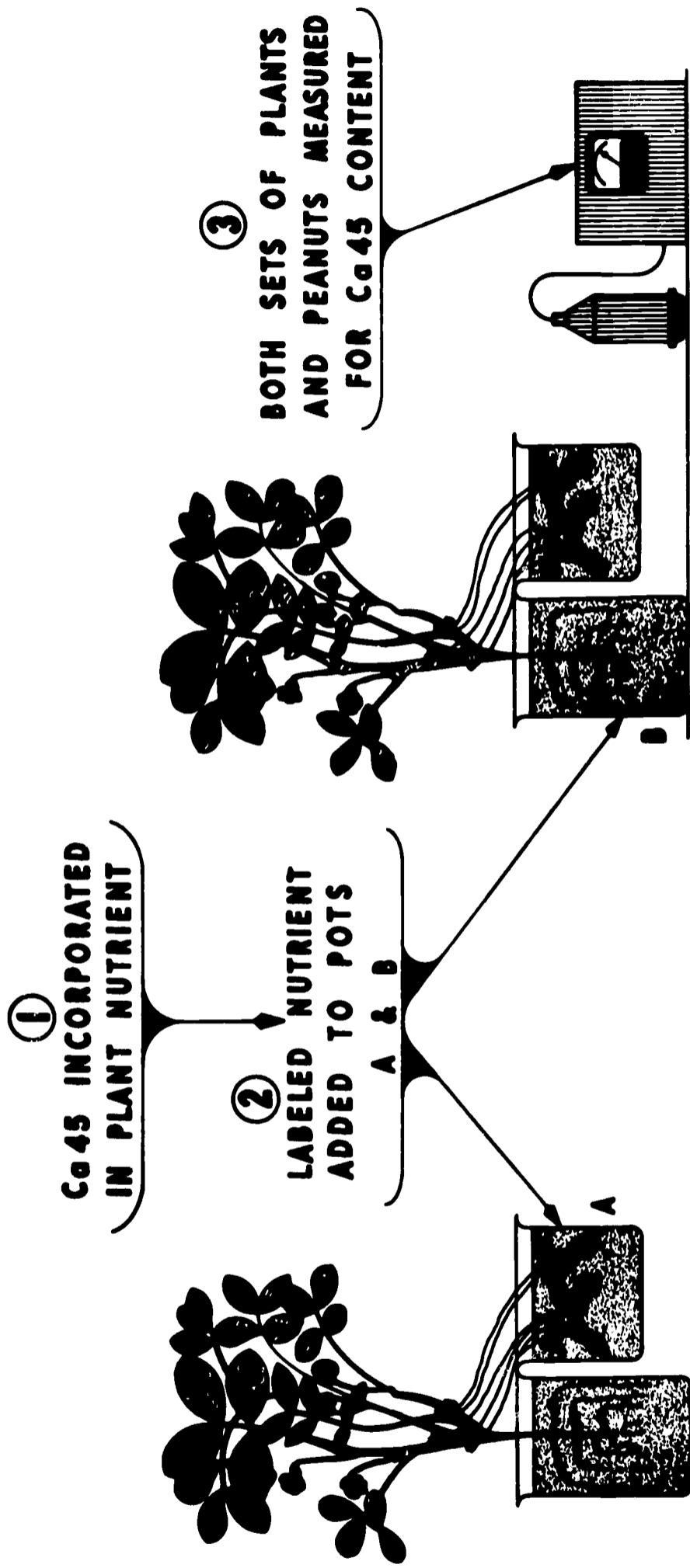

INDICATES:

- 1 - ROOTS SUPPLY INSUFFICIENT CALCIUM FOR FRUIT GROWTH
- 2 - LOCATION OF GREATEST ABSORPTION
- 3 - ABSORPTION DURING EARLY FRUIT GROWTH

USAEC-ID-192

RADIOACTIVE COBALT — CO 60 FOR STUDYING TRACE DEFICIENCIES IN DIET

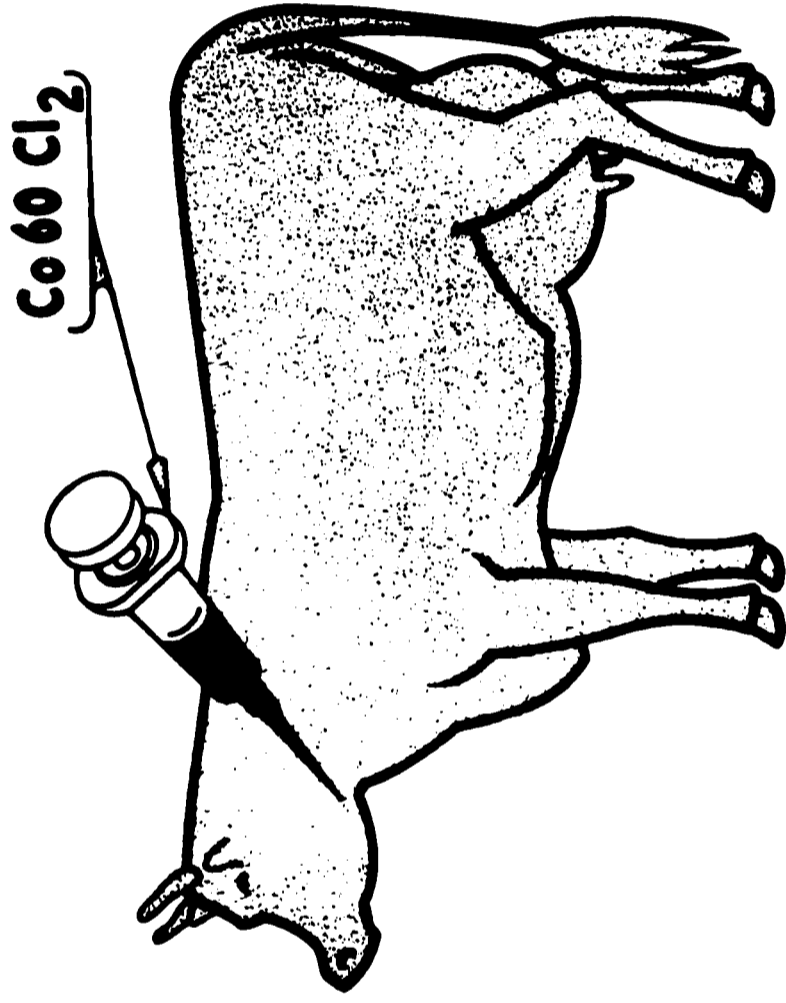

ADVANTAGES:

- 1- RADIO-ANALYSIS RELIABLE FOR TRACE AMOUNTS**
- 2- ONLY TRACE AMOUNTS OF Co 60 NEEDED**
- 3- METABOLIC ACTION INDICATED**

USAEC-1D-276

RADIOACTIVE CALCIUM - Ca 45 FOR STUDYING KINETIC EXCHANGE IN CLAYS

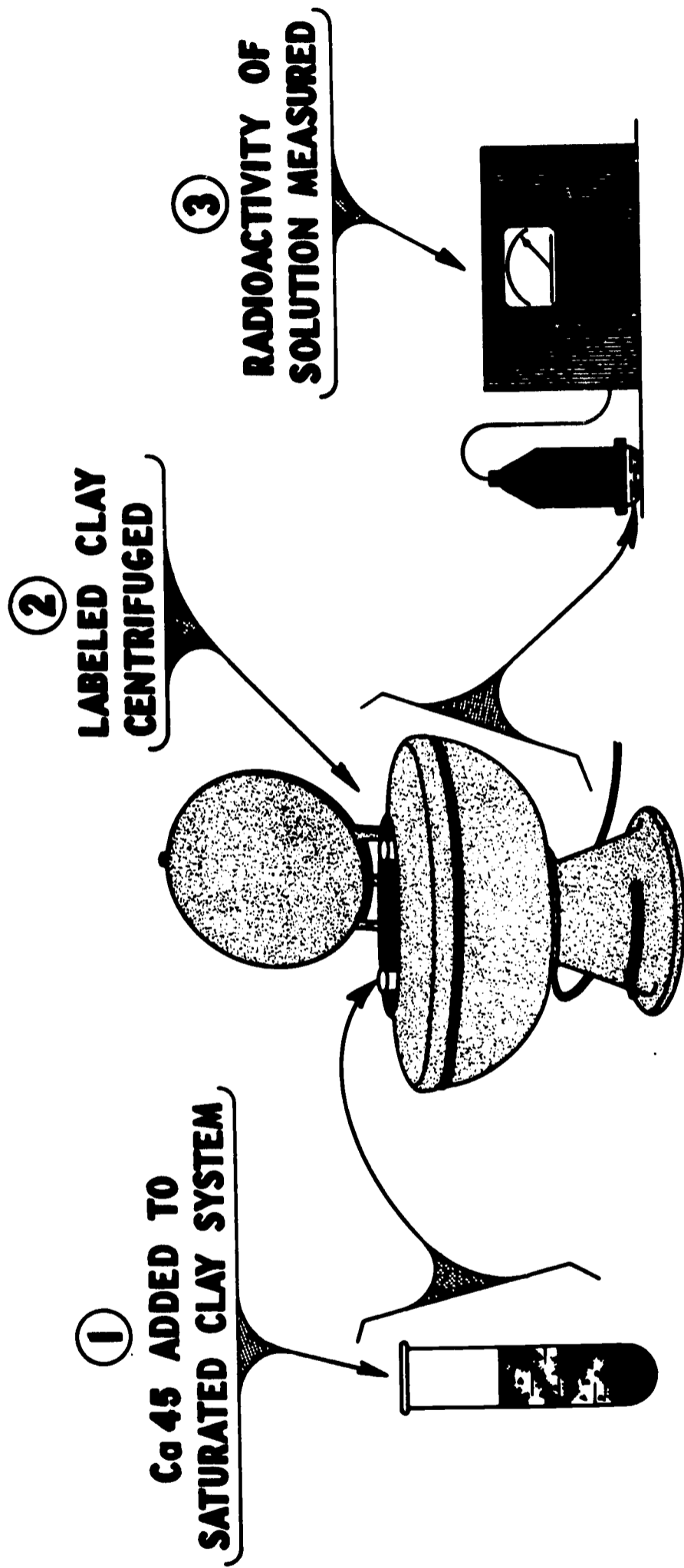

ADVANTAGES:

- 1 - MEASURES EXCHANGE BETWEEN IONS OF SAME ELEMENT
- 2 - CONFIRMS KINETIC EQUILIBRIUM

USAEC-1D-411

RADIOACTIVE PHOSPHORUS - P32

FOR STUDYING PHOSPHORUS UPTAKE FROM GREEN MANURES

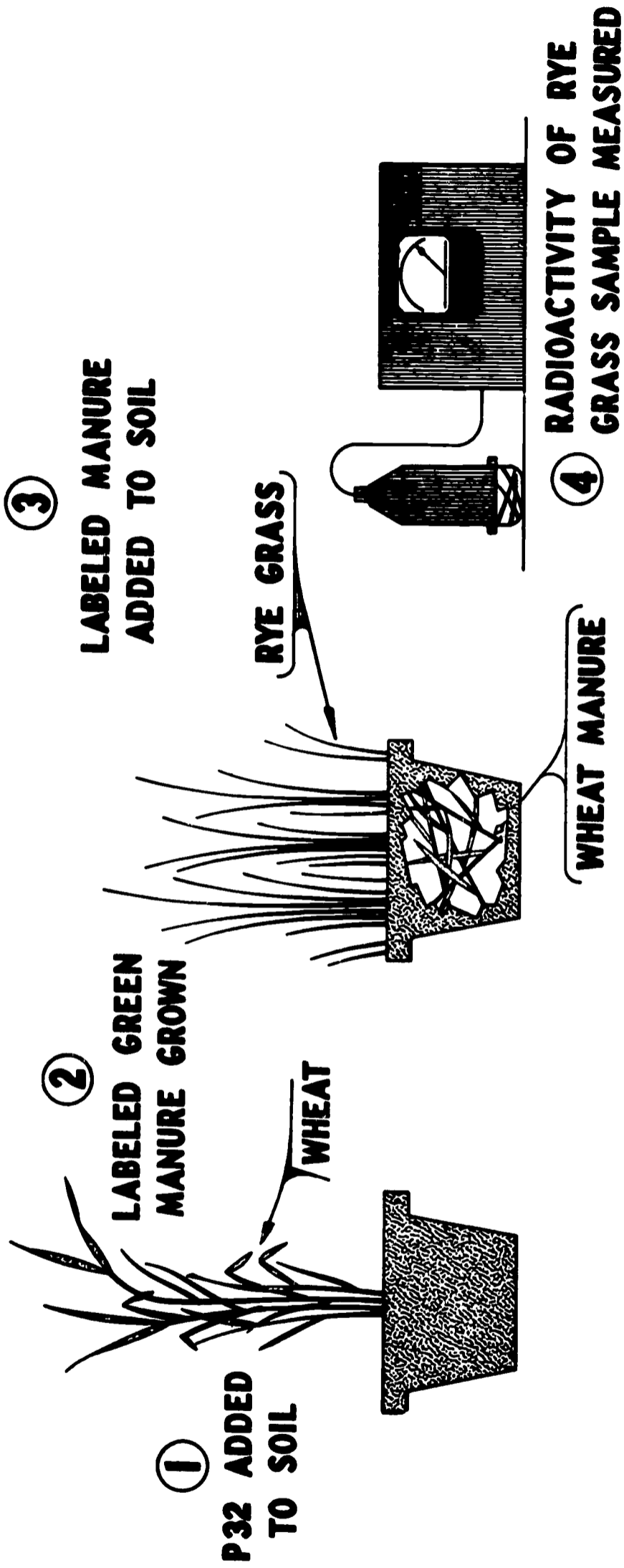

INDICATES:

- 1 - PHOSPHORUS FROM GREEN MANURE AVAILABLE FOR PLANT USE
- 2 - SOIL PHOSPHORUS AND MODE OF PLACEMENT CONTROLS AVAILABILITY

RADIOACTIVE SULFUR - S35

FOR STUDYING SULFUR DAMAGE TO CITRUS FRUITS



①

LABELED SULFUR DUST
APPLIED TO FRUIT

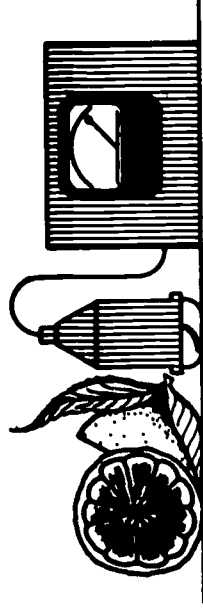

PEEL MEASURED FOR

②

PENETRATION OF S35

③

DETERMINE FORMATION
OF INJURIOUS GASES

④

RADIOACTIVITY OF
GASES MEASURED

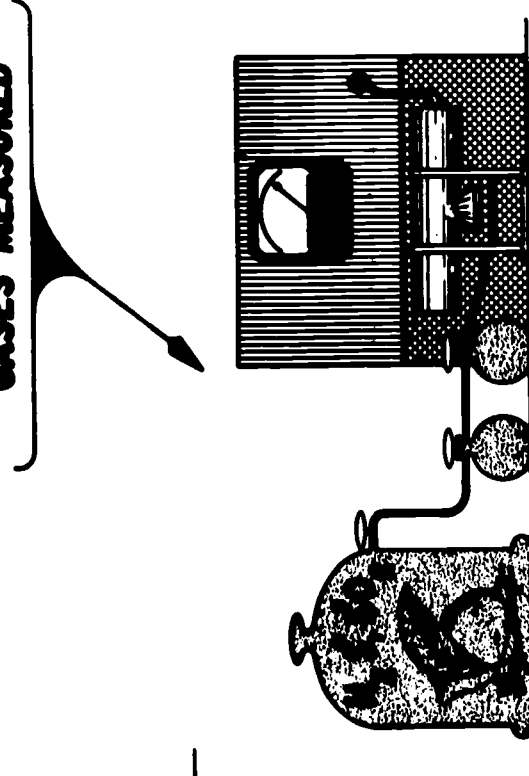

INDICATES:

- 1- PENETRATION OF FRUIT PEEL BY SULFUR ATOMS
- 2- REACTION WITH FRUIT PEEL TO FORM INJURIOUS GASES
- 3- DAMAGE CONFINED TO FRUIT EXPOSED TO SUNLIGHT
- 4- DAMAGE INCREASES WITH TEMPERATURE AND HUMIDITY

USAEC-ID-413

RADIOACTIVE IODINE - I-131

FOR STUDYING MOVEMENT OF PLANT GROWTH REGULATORS

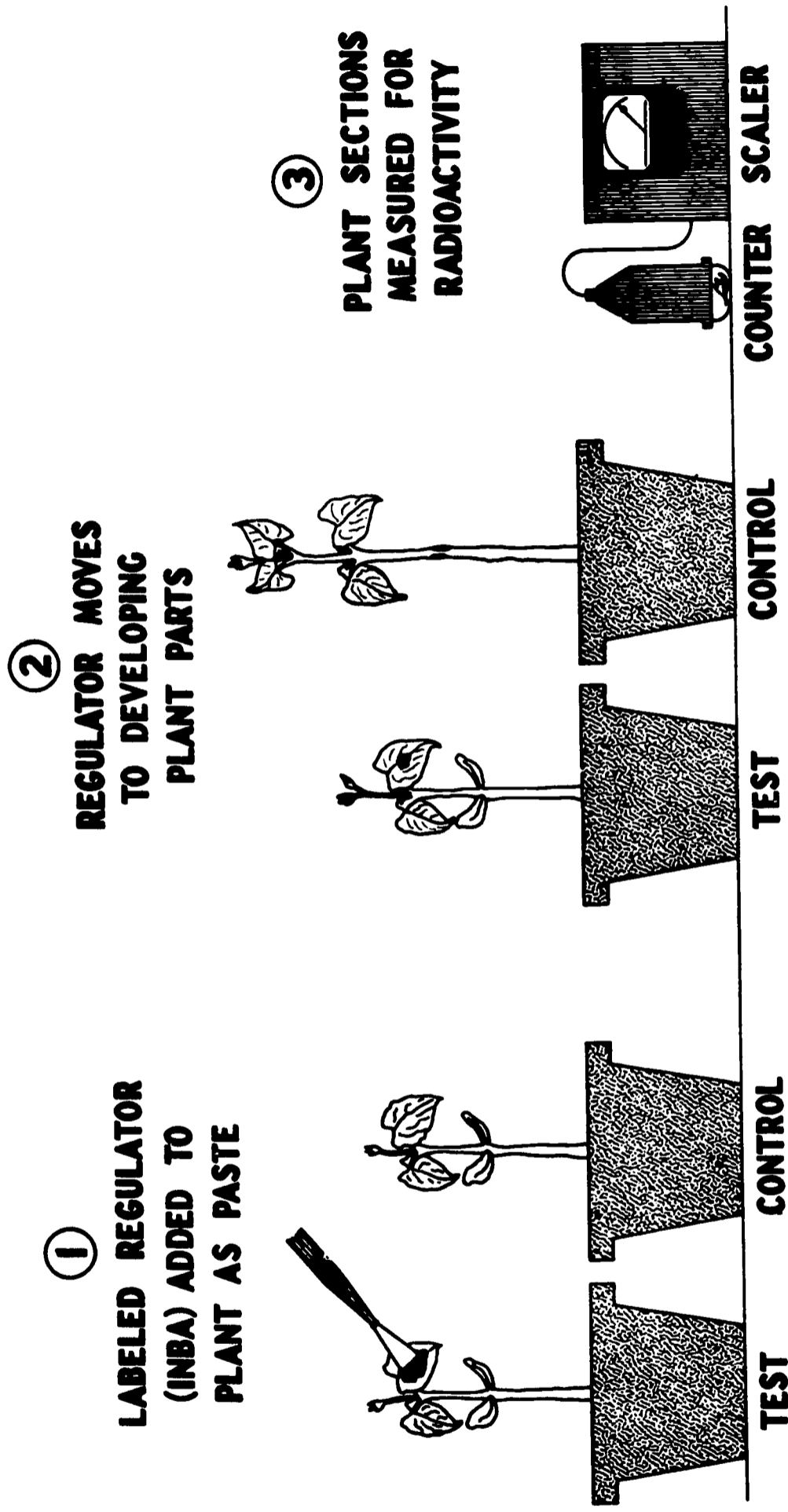

INDICATES:

- 1 - DETAILED PATHWAY OF TRANSLOCATED REGULATOR
- 2 - REGULATOR TRANSLOCATED TO DEVELOPING PARTS OF PLANT, PROBABLY INTACT
- 3 - ACCUMULATION OF REGULATOR IN MILLIONTHS OF GRAM RANGE

RADIOISOTOPES IN AGRICULTURE

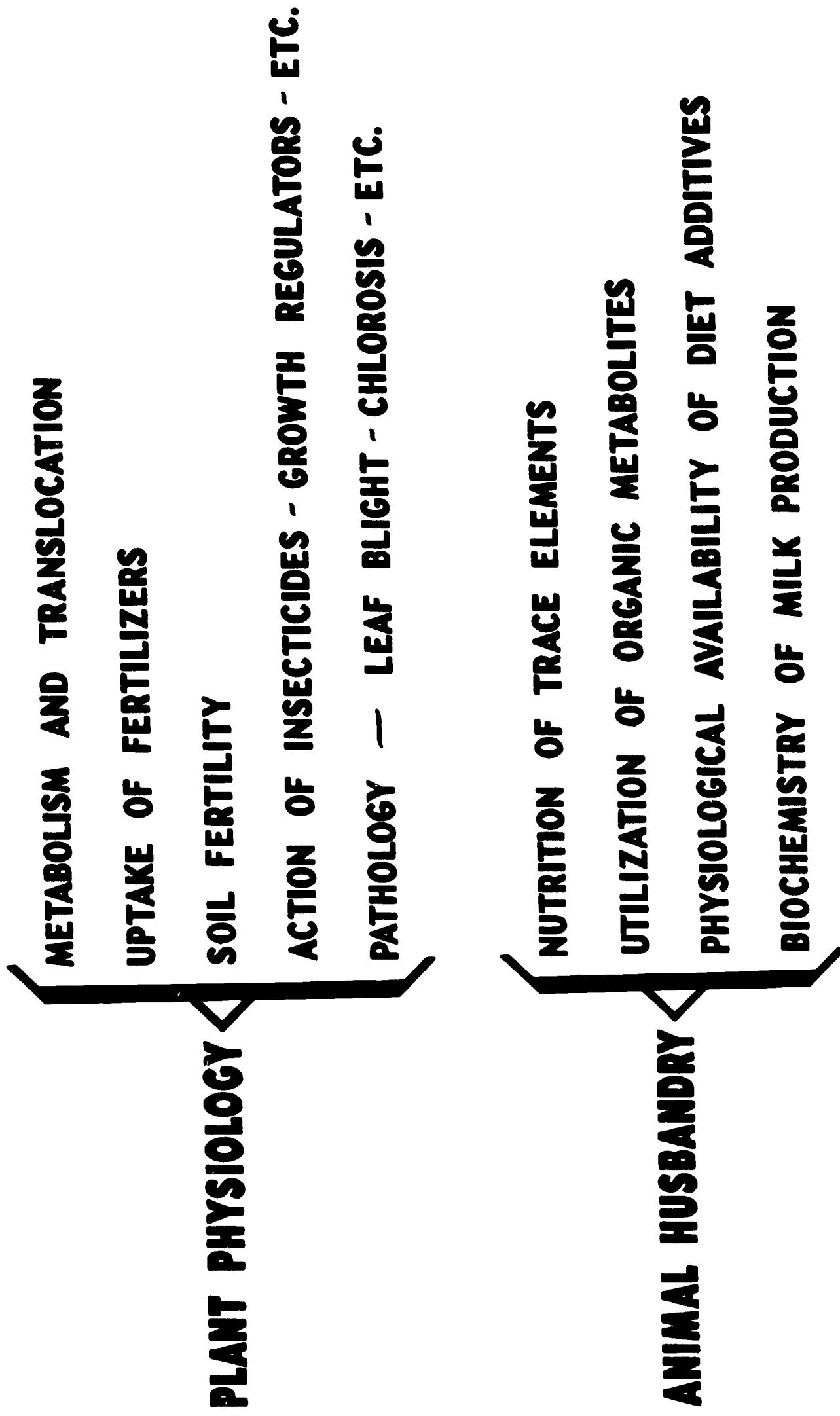

Fertilizer Uptake by Roots and Foliage

USING

RADIOACTIVE PHOSPHORUS - P-32

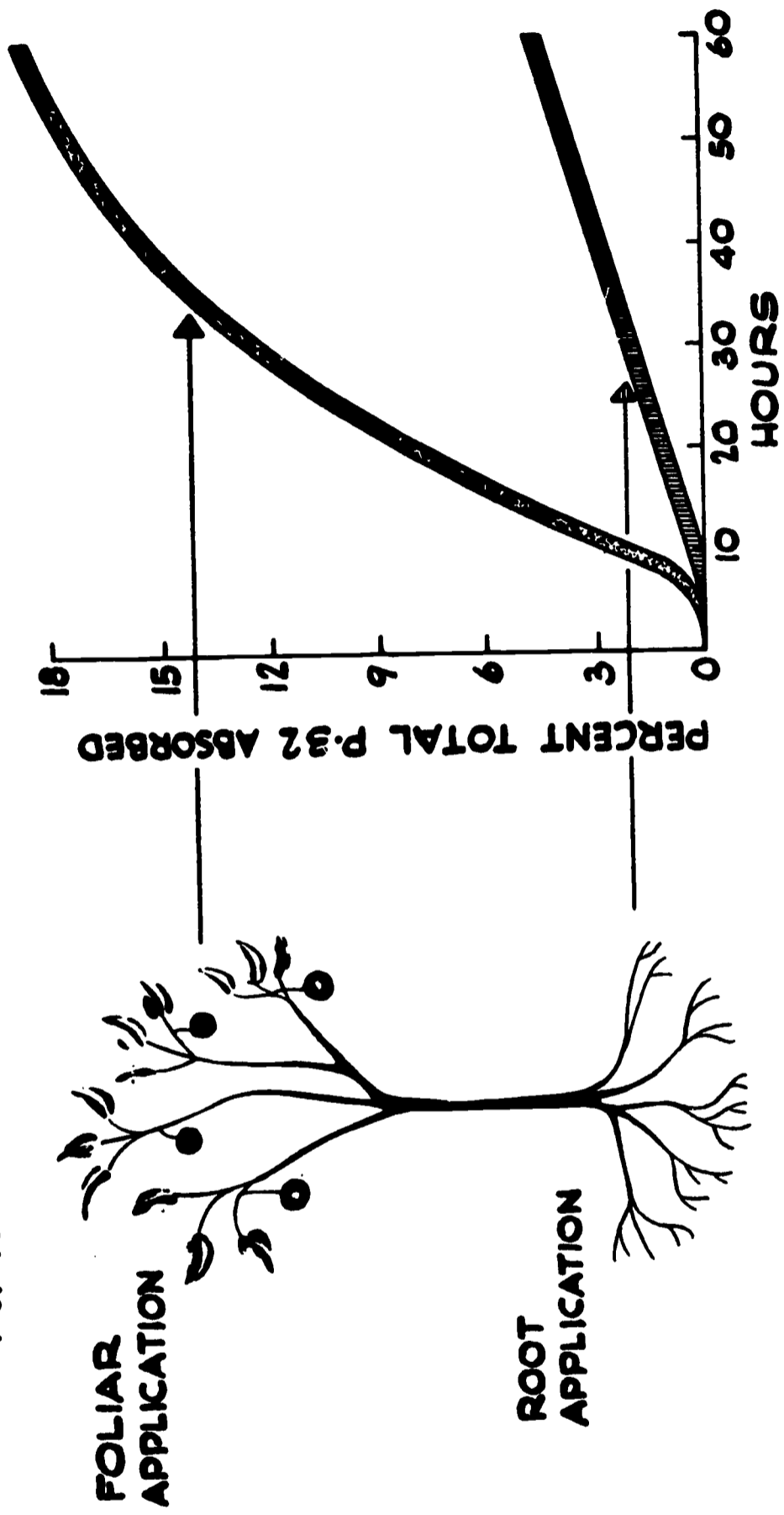

SHOWS: 1-QUICK EFFICIENT WAY TO APPLY FERTILIZER
2-FOLIAR METHOD 95% EFFICIENT - ROOTS 10%
3-CAN BE APPLIED WHEN MOST NEEDED

USAEC-10-277A

**ILLUSTRATIONS OF ISOTOPE APPLICATIONS
IN PHYSICAL SCIENCES**

RADIOACTIVE SODIUM - Na 24

FOR STUDYING ION SORPTION ON SOLID SURFACE

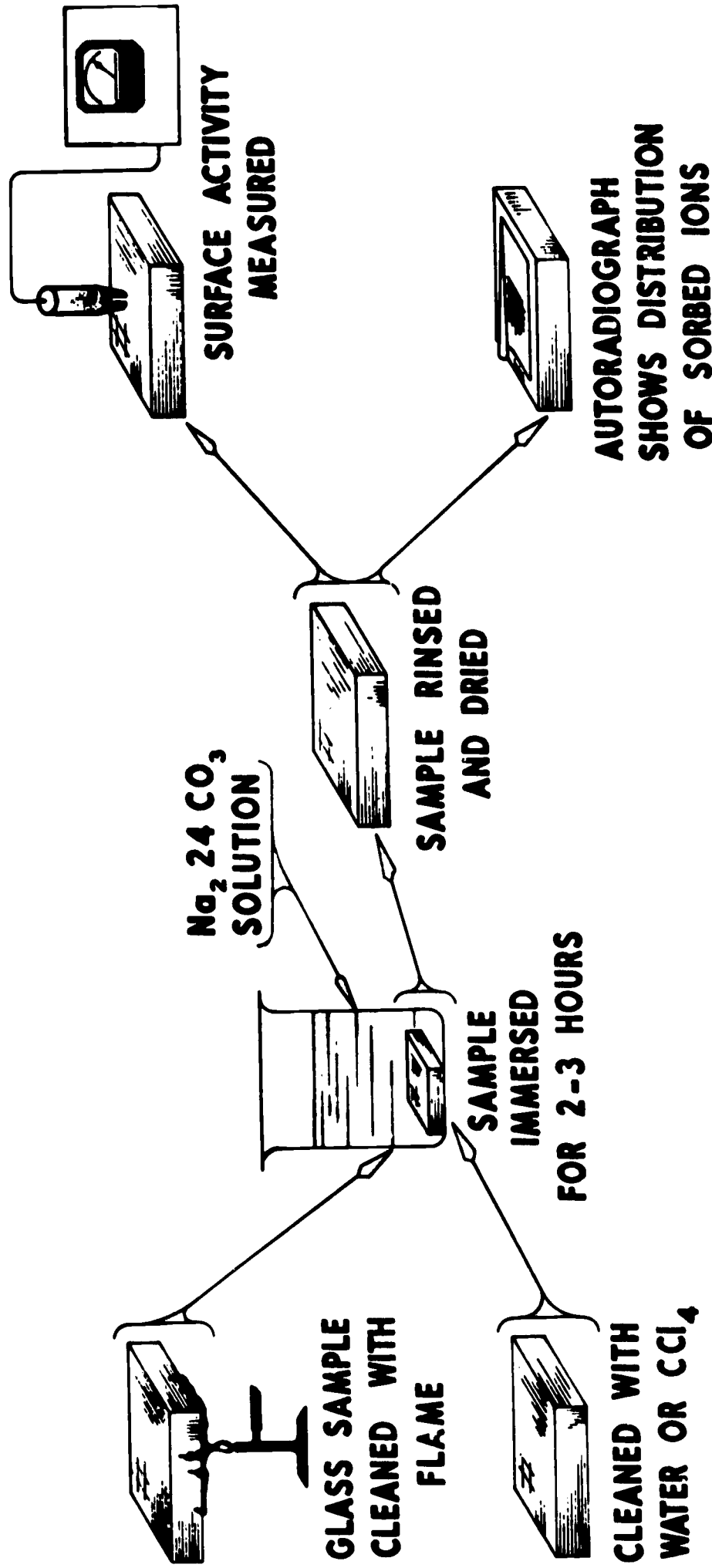

SHOWS:

- 1- SORPTION AT 90°C TEN TIMES GREATER THAN SORPTION AT 25°C
- 2- INITIAL RATE DECREASED FIVE TIMES BY DECREASE IN PH FROM 12 TO 5
- 3- SORPTION RATE DEPENDENT ON SURFACE CLEANLINESS
- 4- FLAME BETTER CLEANER THAN CCl₄ AND WATER

USAEC-10-219

RADIOACTIVE ISOTOPES FOR MEASURING VAPOR PRESSURE OF METALS

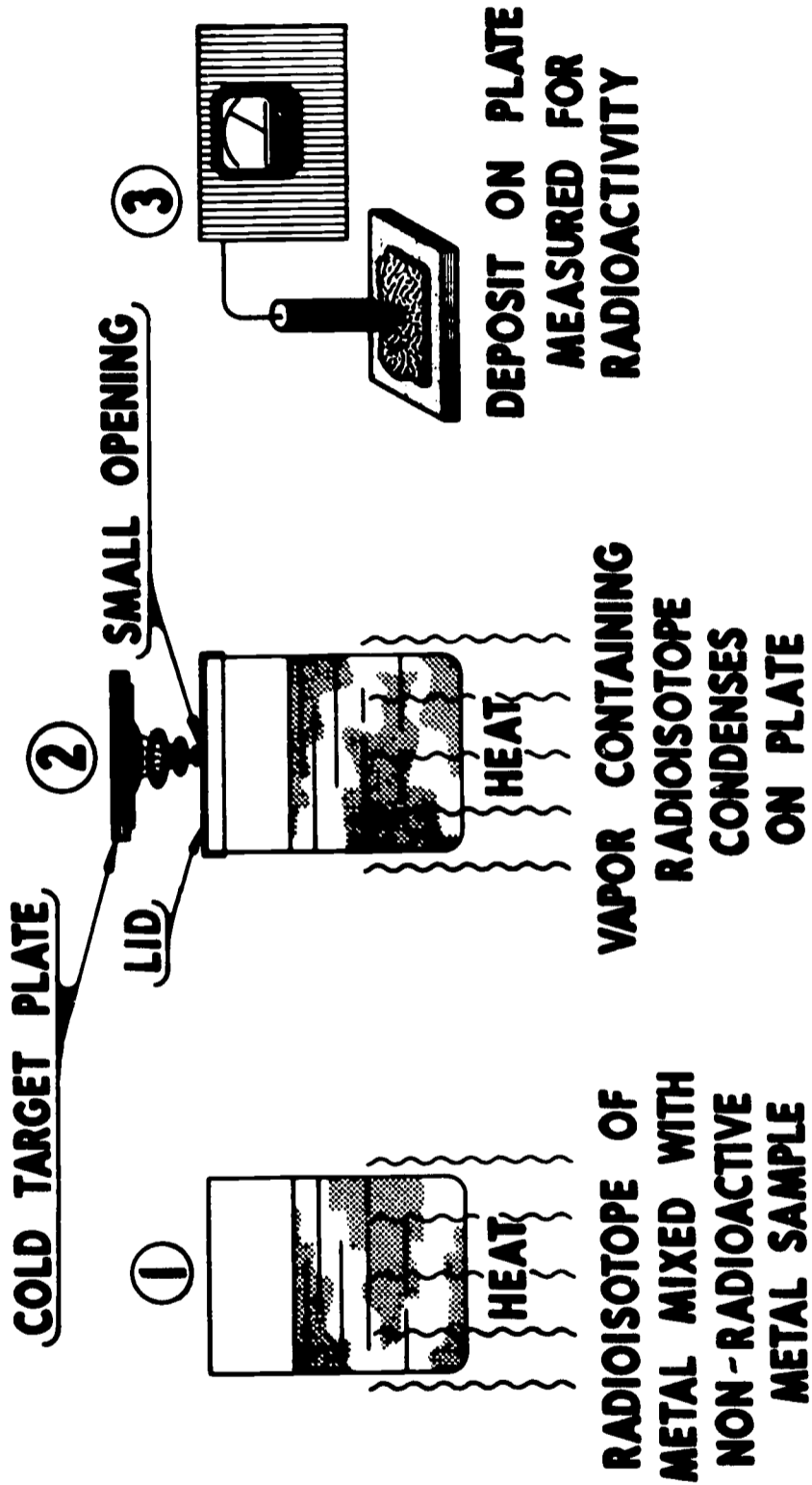

ADVANTAGES:

- 1 - METHOD MORE ACCURATE THAN CHEMICAL OR PHYSICAL METHODS
- 2 - EXPERIMENTAL TECHNIQUES NOT DIFFICULT OR TEDIOUS

SEPARATED MERCURY ISOTOPE - Hg 202

FOR NEW PRIMARY WAVE-LENGTH STANDARD

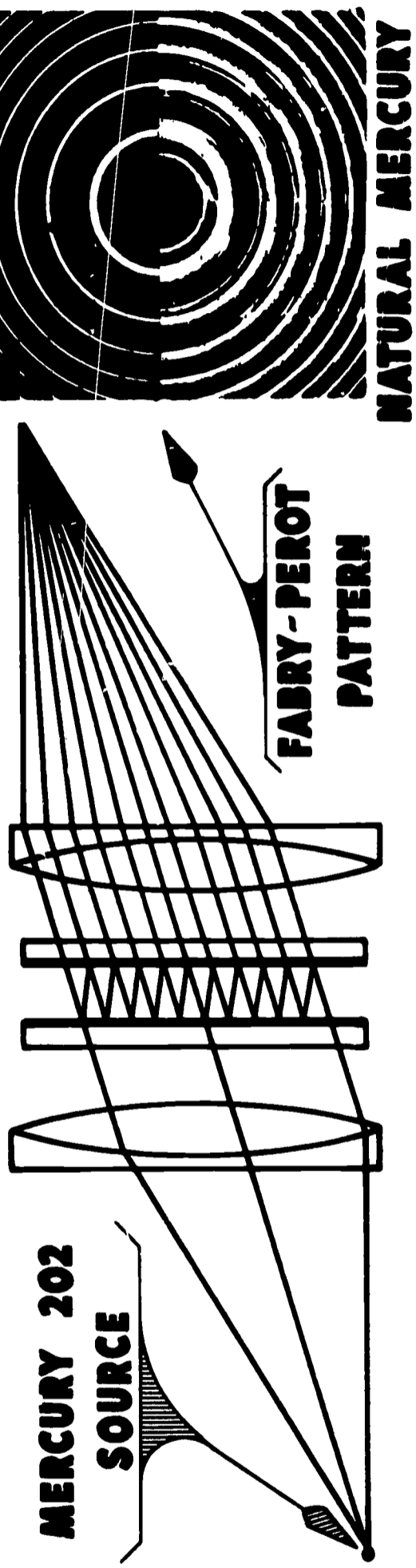

ADVANTAGES: OVER USE OF CADMIUM RED LINE

- 1 - LINES FREE OF HYPERFINE AND ISOTOPE STRUCTURES
- 2 - HIGH VISIBLE INTENSITY
- 3 - MERCURY MORE EASILY EXCITED THAN CADMIUM
- 4 - PRECISION OF MEASUREMENT (ONE PART PER FIFTY MILLION)

USAEC-ID-17A

DECOMPOSITION OF WATER BY IONIZING RADIATION

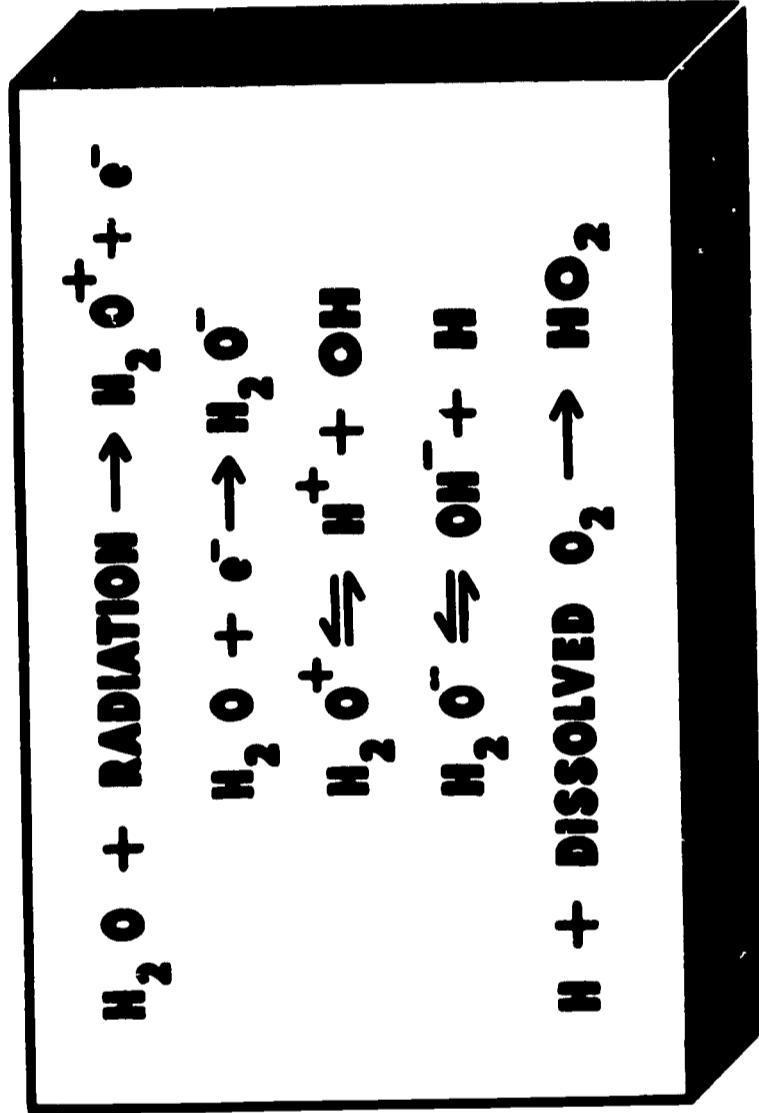

RADICALS H, OH, AND HO₂ BEHAVE AS FREE ATOMS — VERY REACTIVE
OH AND HO₂ OXIDIZE DISSOLVED SUBSTANCES
H REDUCES DISSOLVED SUBSTANCES

USAEC-D-190A

SCINTILLATION COUNTER

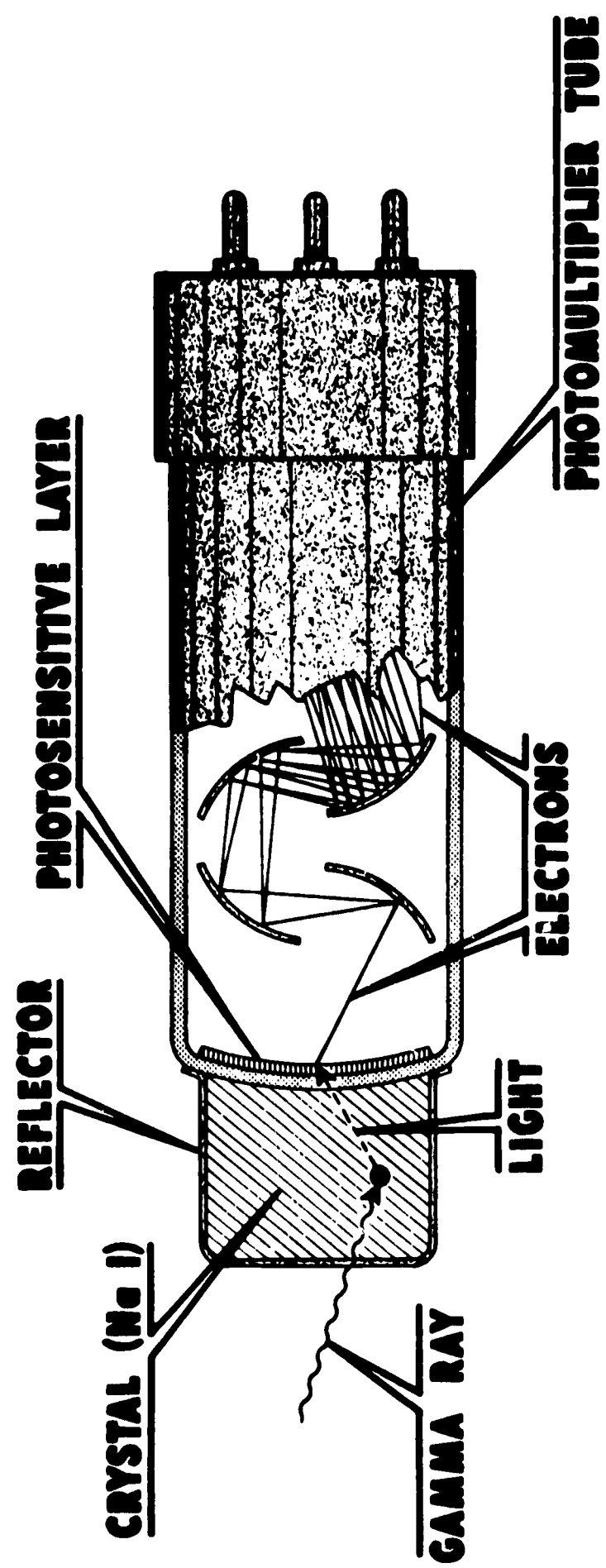

TOTAL LIGHT TO TUBE NEARLY PROPORTIONAL TO GAMMA RAY ENERGY

**IF 1 ELECTRON EJECTS 5 FROM A DYNODE, 11 DYNODES RESULT IN 5¹¹
OR
ABOUT 50 MILLION ELECTRONS OUTPUT**

USAEC-ID-193A

THE GEIGER-MÜLLER COUNTER

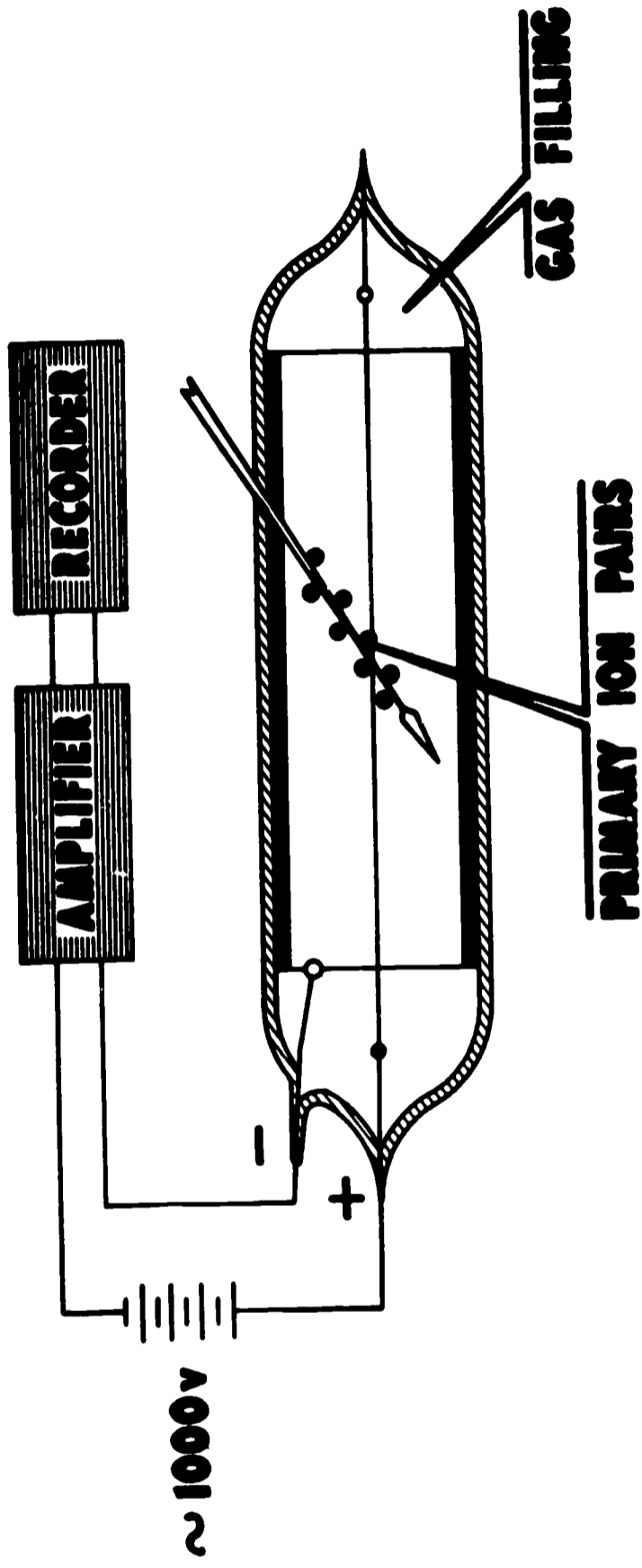

MATERIALS AND FILLING SUITABLE FOR α , β , γ , OR NEUTRONS

THIN CENTRAL WIRE GIVES HIGH FIELD FOR AVALANCHES

1 OR 1,000,000 PRIMARIES GIVE SINGLE PULSE

USAEC-D-194A

THE LAURITSEN ELECTROSCOPE

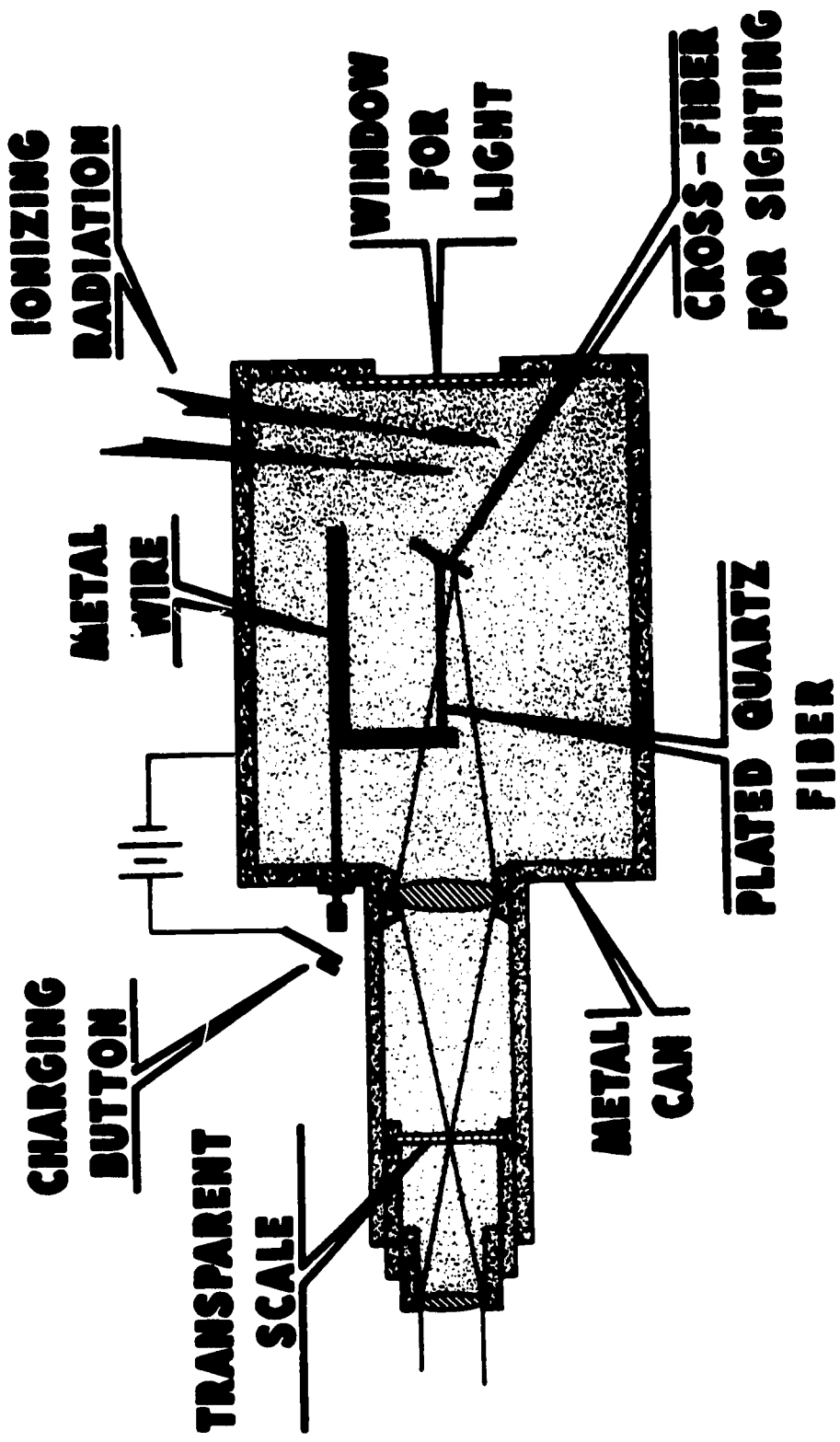

- . CHARGE BENDS FIBER FROM WIRE
- . IONS PRODUCED IN GAS BY RADIATION
- . IONS MOVE TO WIRE AND REDUCE CHARGE
- . AMOUNT OR RATE OF IONIZATION OBSERVED WITH TELESCOPE

USAEC-ID-195A

NEED FOR QUENCHING IN G-M TUBE

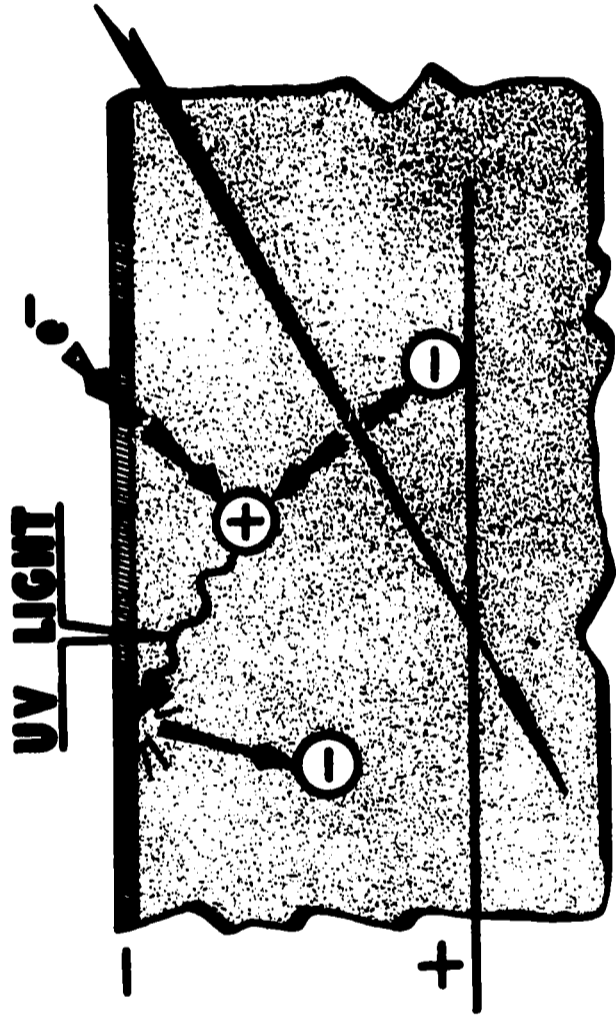

- . POSITIVE ION DRAWS ELECTRON FROM CATHODE
- . ION BECOMES EXCITED ATOM
- . ATOM RADIATES IN ULTRAVIOLET
- . LIGHT EJECTS PHOTOELECTRON FROM CATHODE
- . ELECTRON INITIATES FURTHER CASCADES

USAEC-ID-196A

THE IONIZATION CHAMBER

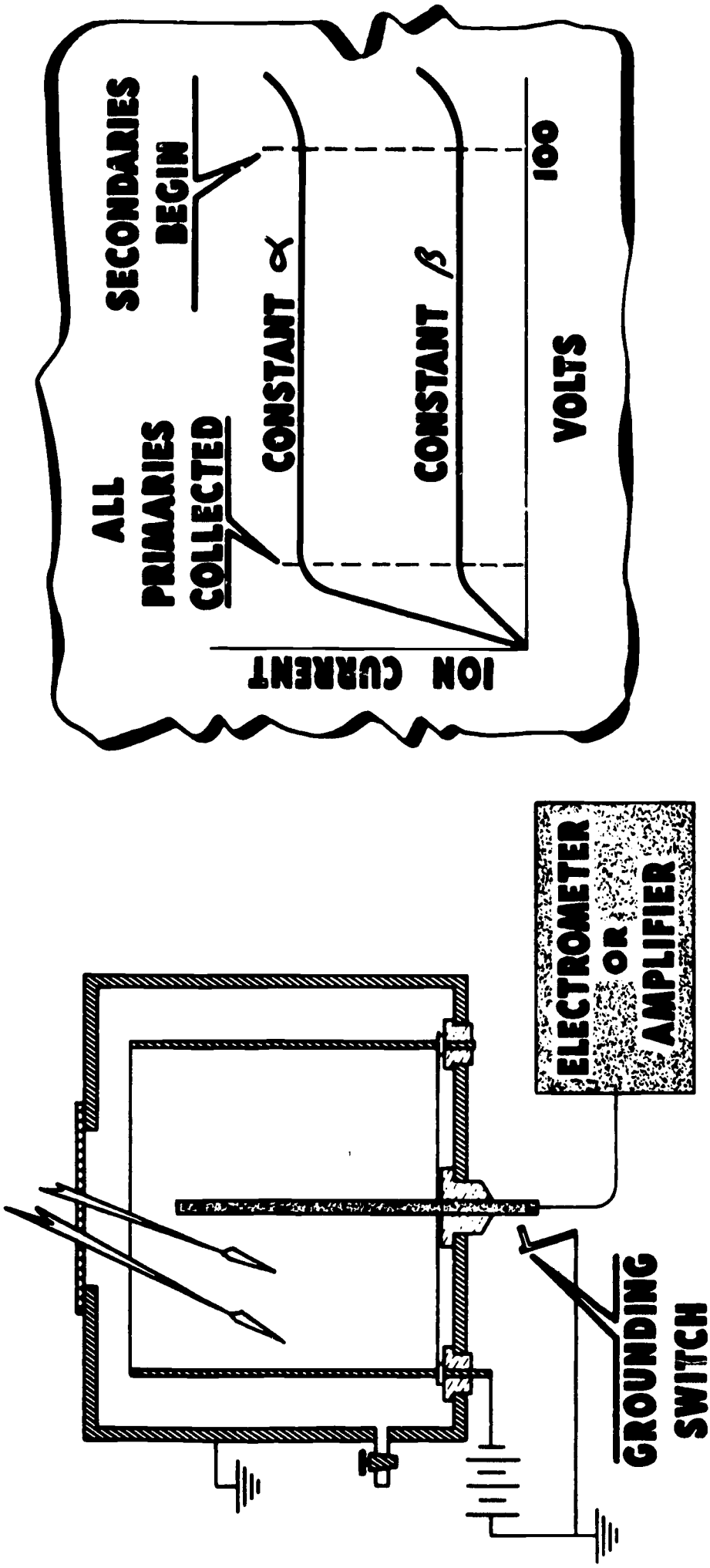

- SENSITIVE TO ALL RADIATIONS
- LOW - ACTIVITY CAN BE MEASURED --- BUT
 - ..AUXILIARIES EXPENSIVE
 - ..ADJUSTMENTS DIFFICULT

USAEC-ID-197A

THE PROPORTIONAL COUNTER

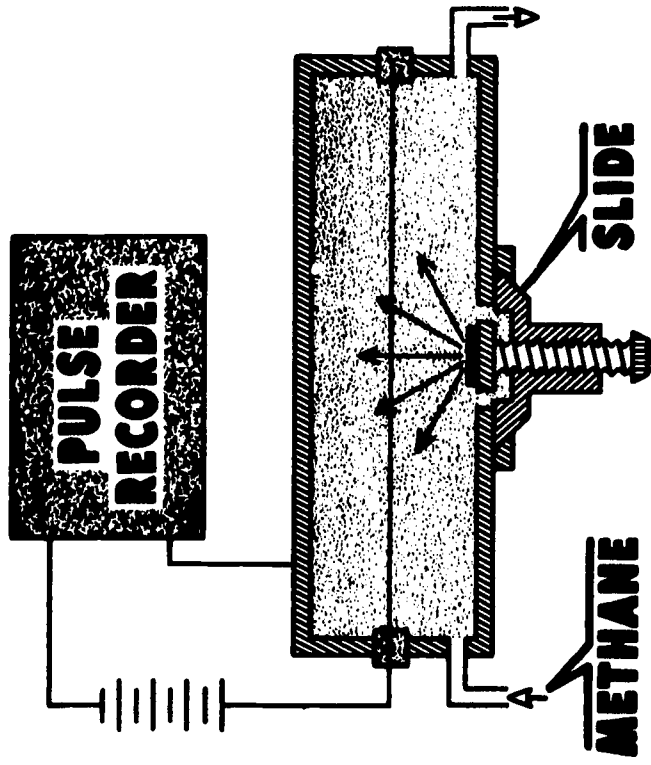

GAS - FLOW TYPE

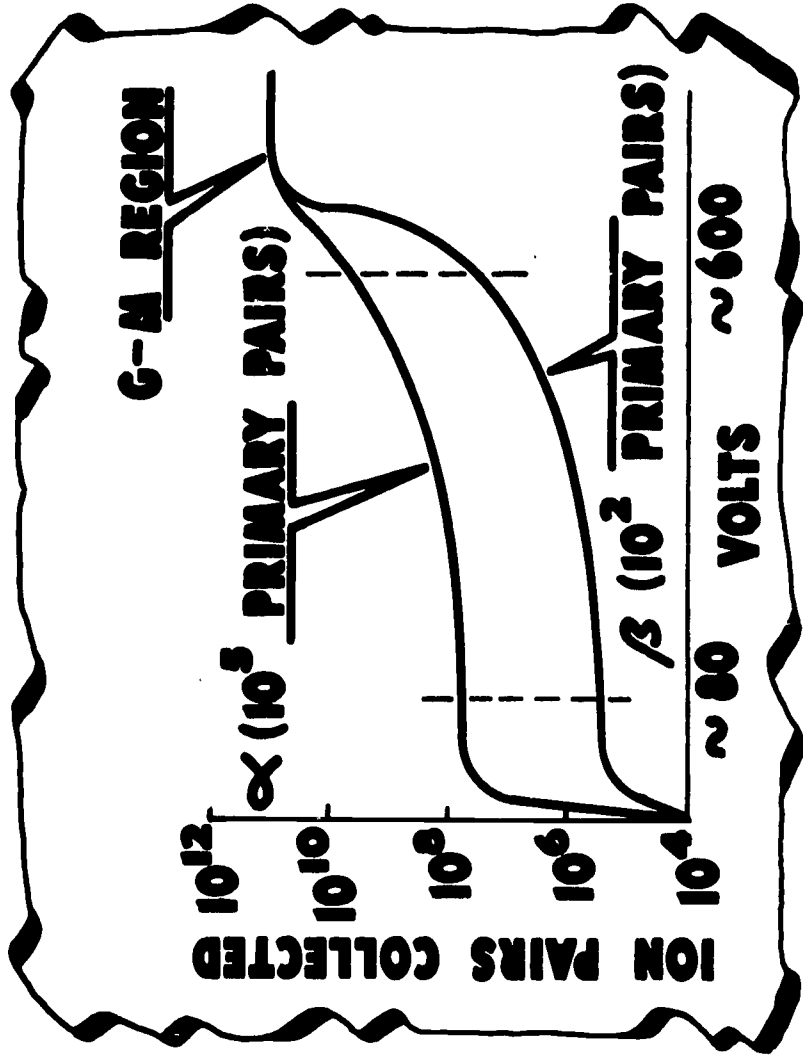

- . PULSES PROPORTIONAL TO IONIZING POWER
- . RECORDER CAN BE SET FOR PULSE SIZE RANGE
- . CAN COUNT α 'S IN LARGE FLUX OF β 'S
- . NO WINDOW TO STOP PARTICLES

USAEC-ID-198A

DEAD TIME OF G-M COUNTER

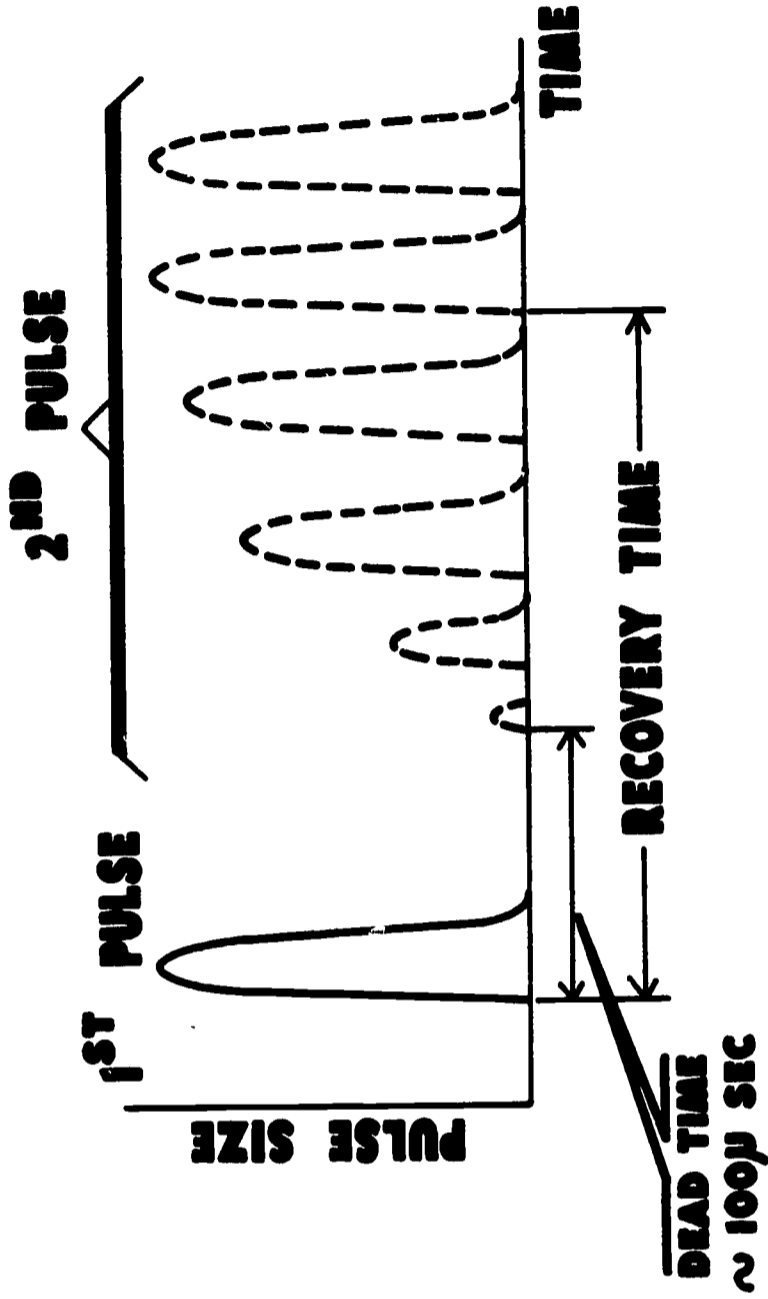
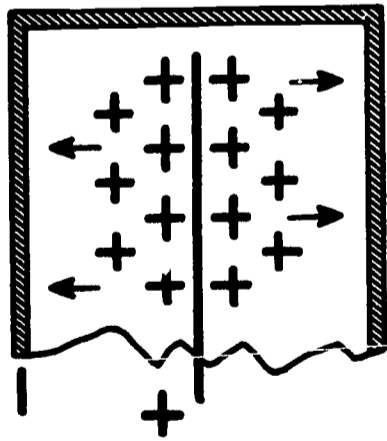

- . HEAVY POSITIVE IONS SLOW TO CLEAR
- . REDUCE EFFECTIVENESS OF FIELD NEAR WIRE
- . REDUCE SPEED OF ELECTRONS
- . REDUCE SIZE OF NEXT AVALANCHE

USAEC-ID-199A

IONIZATION CURRENT

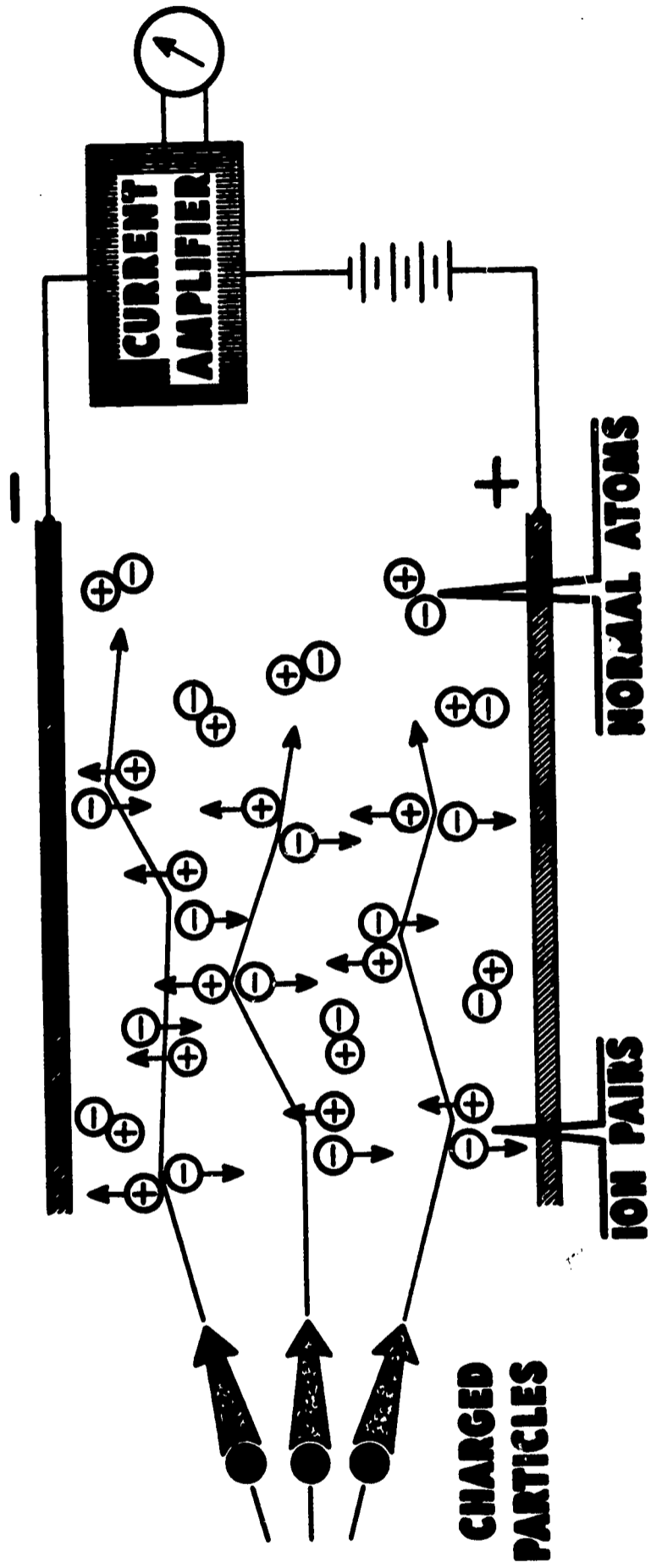

- INCOMING PARTICLES IONIZE ATOMS
- ELECTRODES ATTRACT IONS
- ARRIVAL OF IONS CONSTITUTES CURRENT
- CURRENT IS MEASURE OF PARTICLES

USAEC-ID-200A

ACTION OF QUENCHING GAS IN G-M TUBES

EXCITED POLYATOMIC MOLECULE
DISSOCIATES INSTEAD
OF RADIATING

POLYATOMIC MOLECULE
GIVES UP ELECTRON.
TRAVELS AS + ION

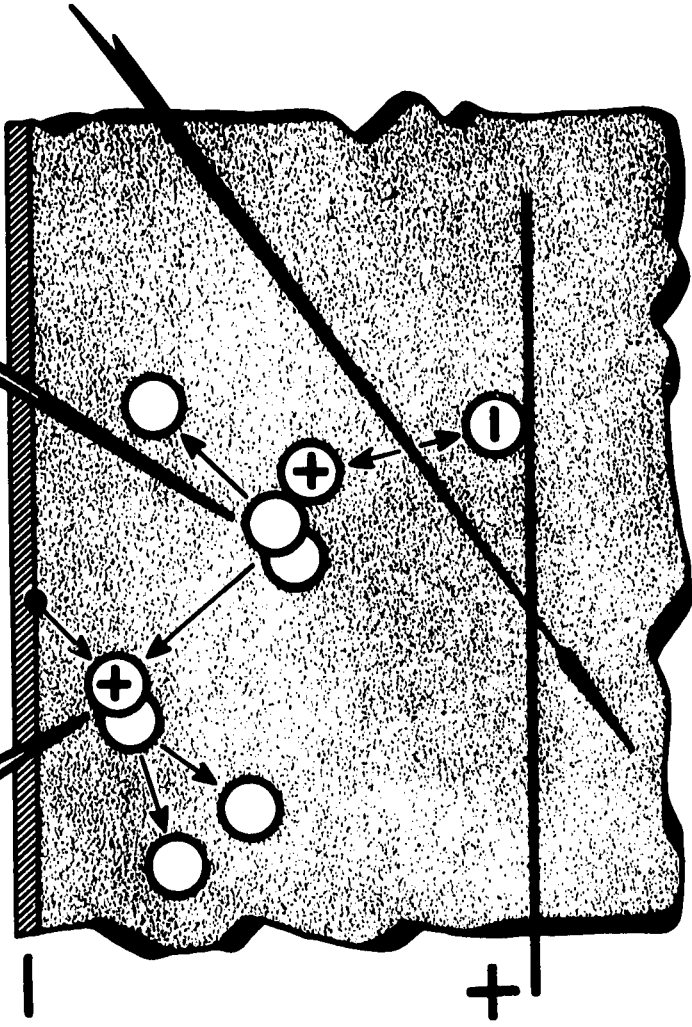

TYPICAL GAS

90% ARGON

10% ETHYL ALCOHOL OR
AMYL ACETATE, ETC.

NEARLY COMPLETE SUPPRESSION OF SPURIOUS COUNTS
BUT...
DISSOCIATION OF GAS LIMITS USEFUL LIFE

USAEC-ID-201A

GAS AMPLIFICATION

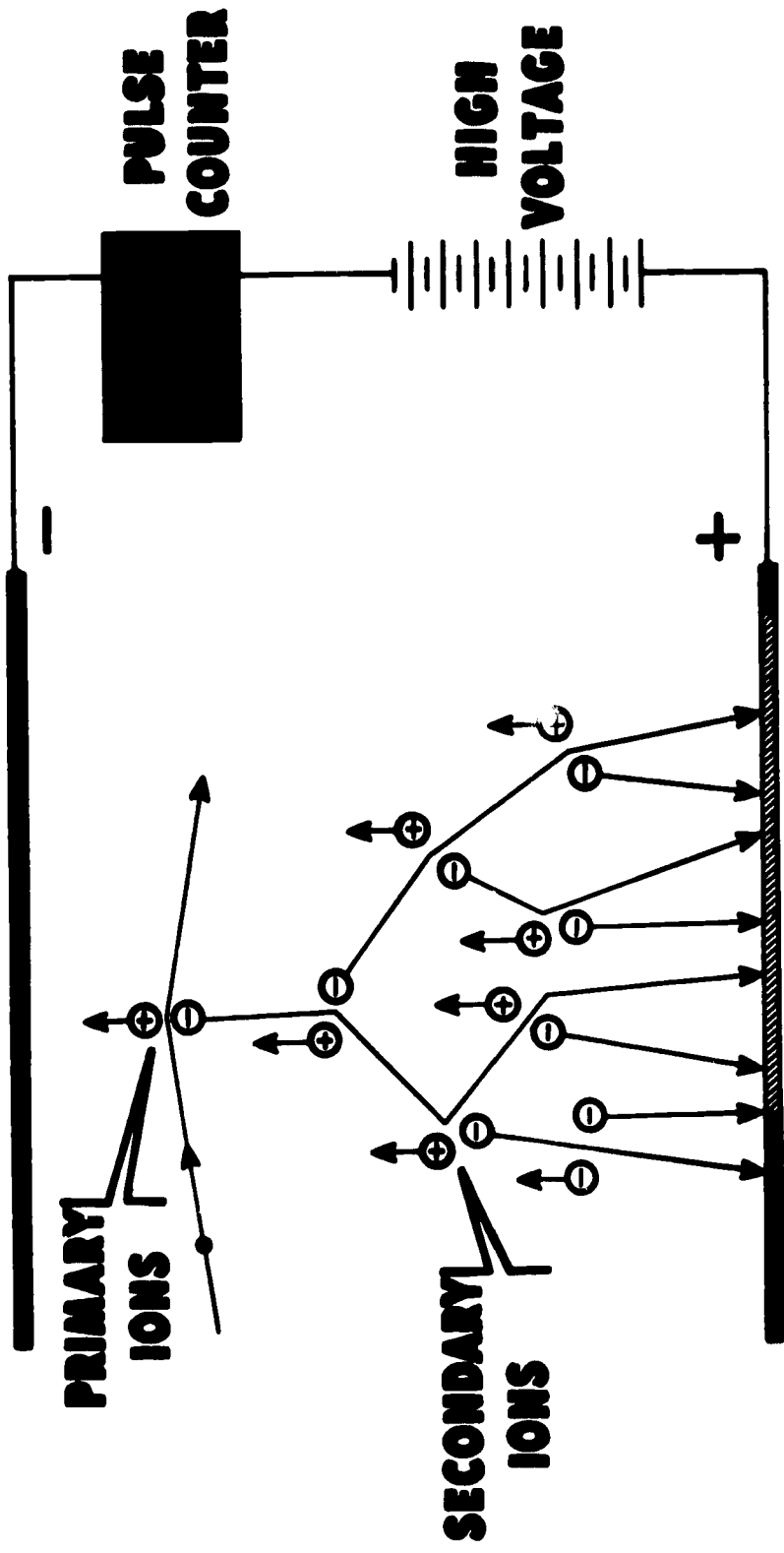

- ELECTRONS RECEIVE ENOUGH ENERGY TO IONIZE
- AVALANCHE OF SECONDARIES
- CURRENT MULTIPLIED BY 1.000 TO 1.000.000

USAEC-ID-202A

THE GEIGER-MÜLLER PLATEAU

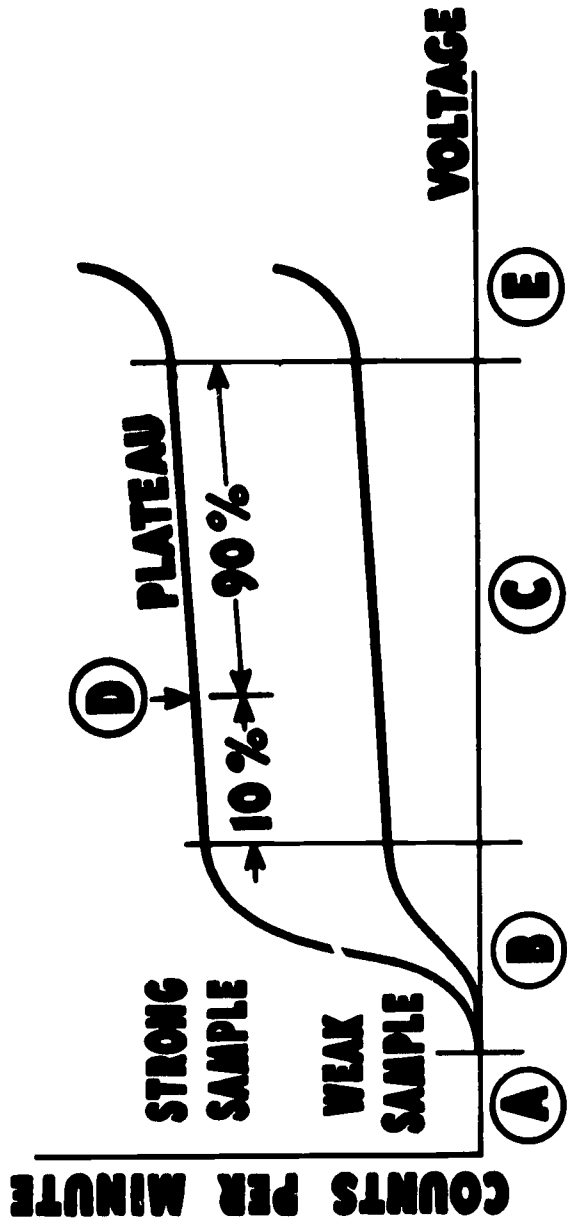

- (A) NO PULSES LARGE ENOUGH FOR RECORDER**
- (B) AVALANCHES GROW LARGER WITH VOLTAGE
NUMBER OF RECORDER PULSES INCREASES**
- (C) ALL PARTICLES TRIGGER MAXIMUM AVALANCHE
ALL PULSES RECORDED**
- (D) OPTIMUM SETTING FOR OPERATING VOLTAGE
HIGHER VOLTAGE GIVES SHORTER TUBE LIFE**
- (E) SPURIOUS DISCHARGES LEAD TO BREAKDOWN**

THE STANDARD ERROR IN PARTICLE COUNTING

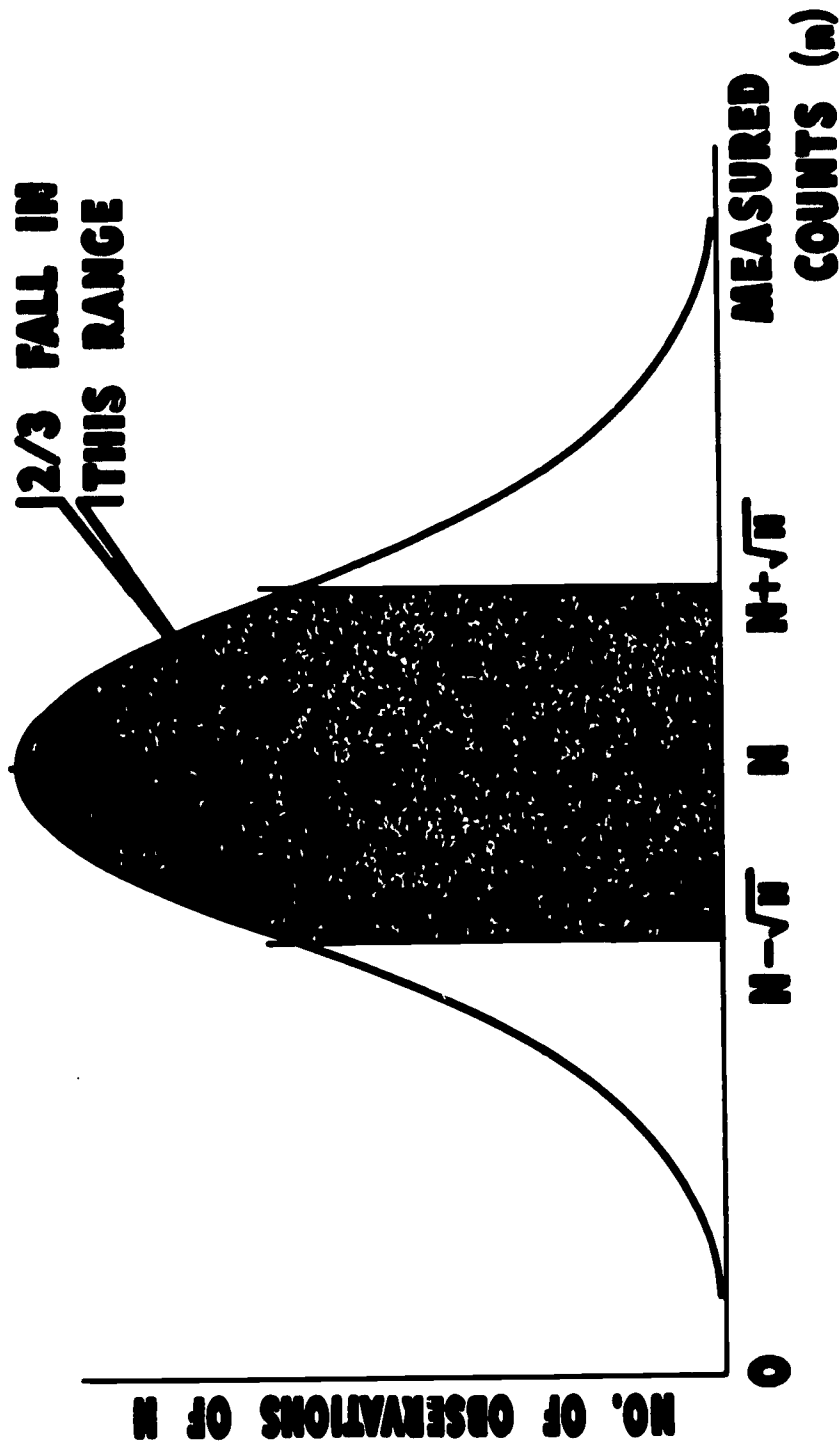

THE PROBABILITY CURVE

... IF UNKNOWN N IS MEASURED AS n ,
2/3 OF REPEATS EXPECTED TO BE WITHIN $n \pm \sqrt{n}$

USAEC-ID-205A

CONSIDERATIONS IN RADIOACTIVITY MEASUREMENTS

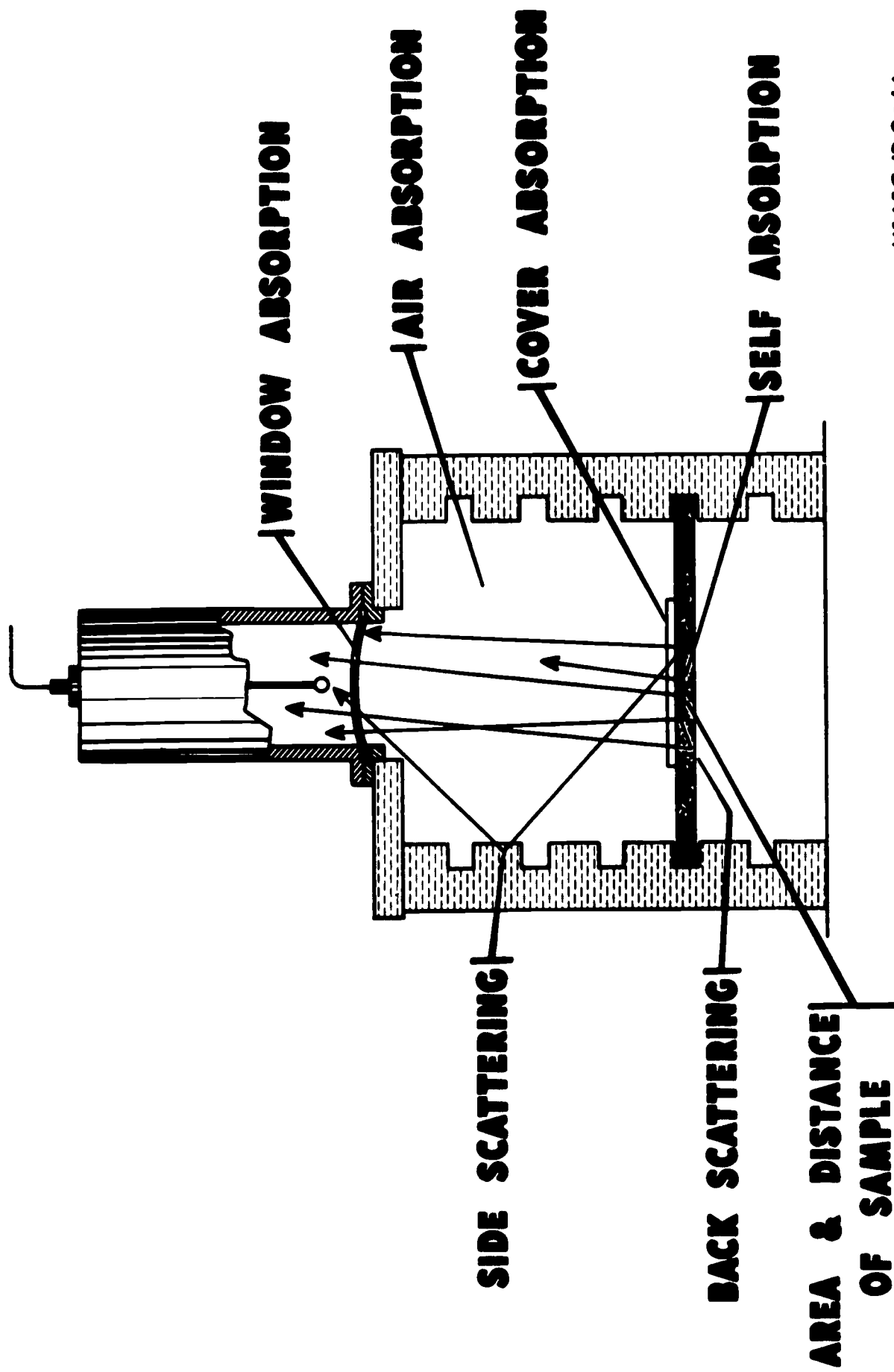

USAEC-ID-206A

NEED FOR LARGE COUNTS TO REDUCE ERROR

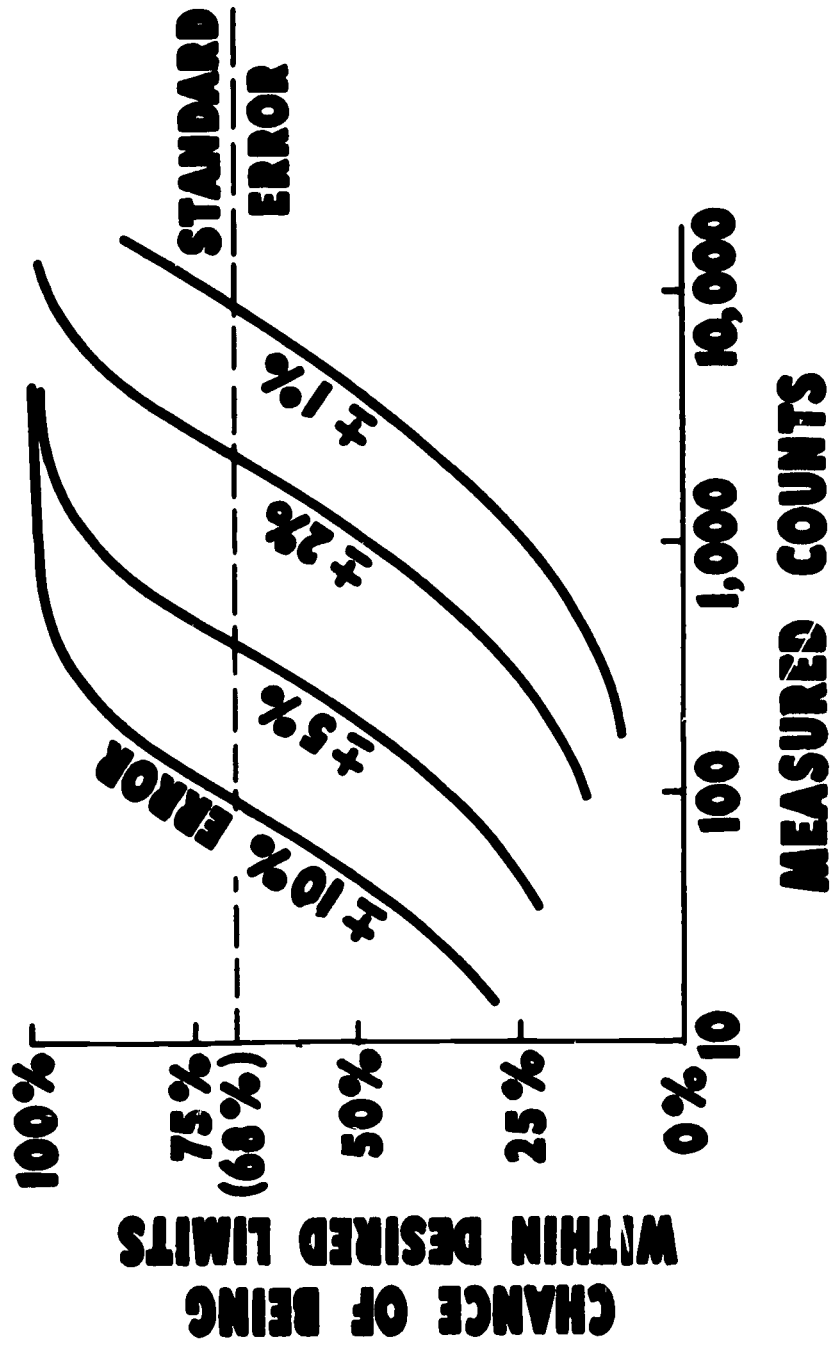

HIGH PROBABILITY OF LOW ERROR REQUIRES HIGH COUNT

USAEC-ID-207A

TYPES OF GEIGER-MÜLLER COUNTERS

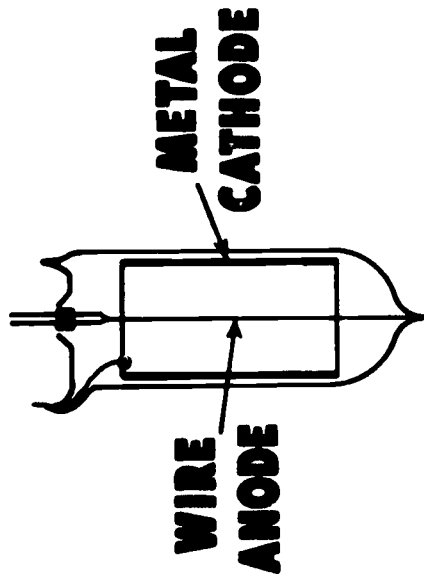

**COMMON
TYPE**

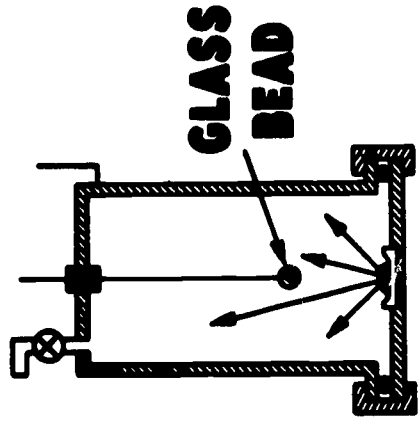

**INTERNAL
COUNTER**

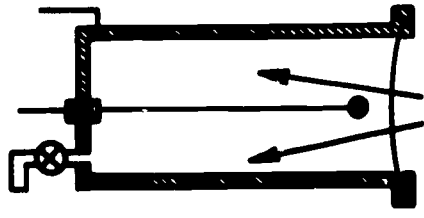

**THIN WINDOW
 β COUNTER**

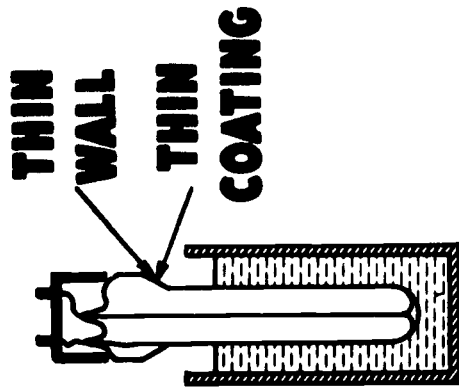

**IMMERSION
 β COUNTER**

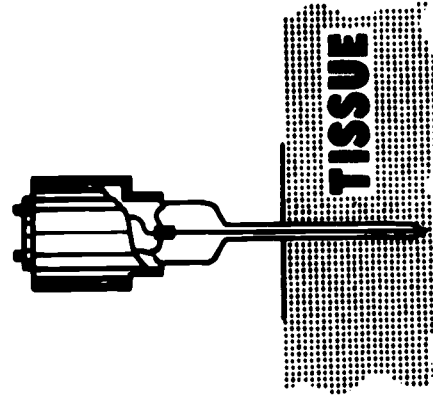

**TISSUE
PROBE**

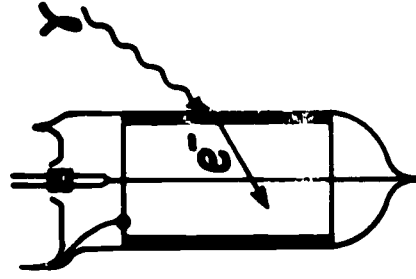

**BISMUTH WALL
COUNTER**

USAEC-ID-213A

MECHANISM OF CHROMATE INDUCED PASSIVITY

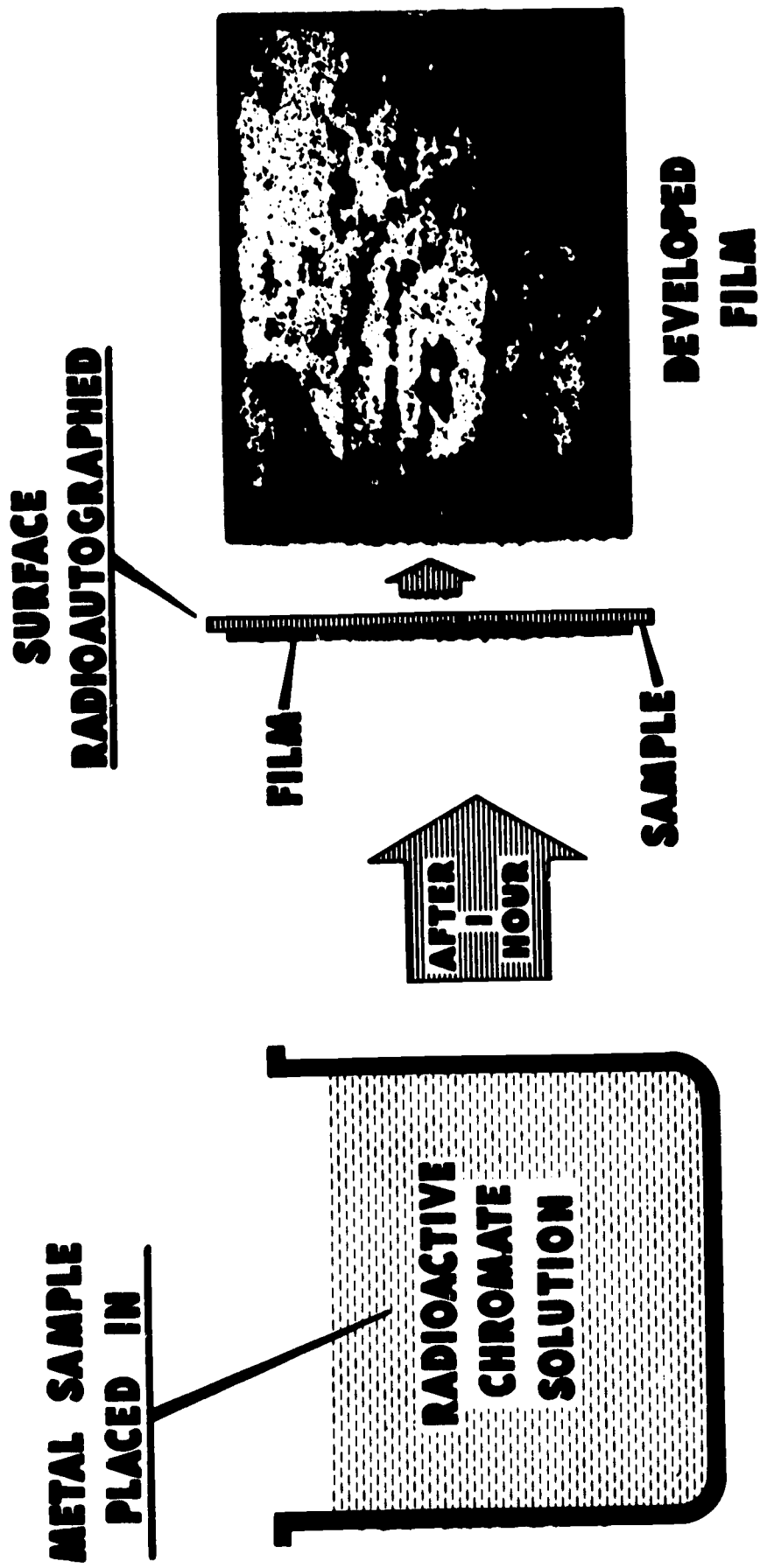

**Cr 51 CONCENTRATES AT POINTS OF CORROSION—
SUPPORTING OXIDE FILM THEORY**

USAEC-D-218A

DETERMINATION OF DEPOSIT THICKNESS IN VACUUM - CAST FILMS

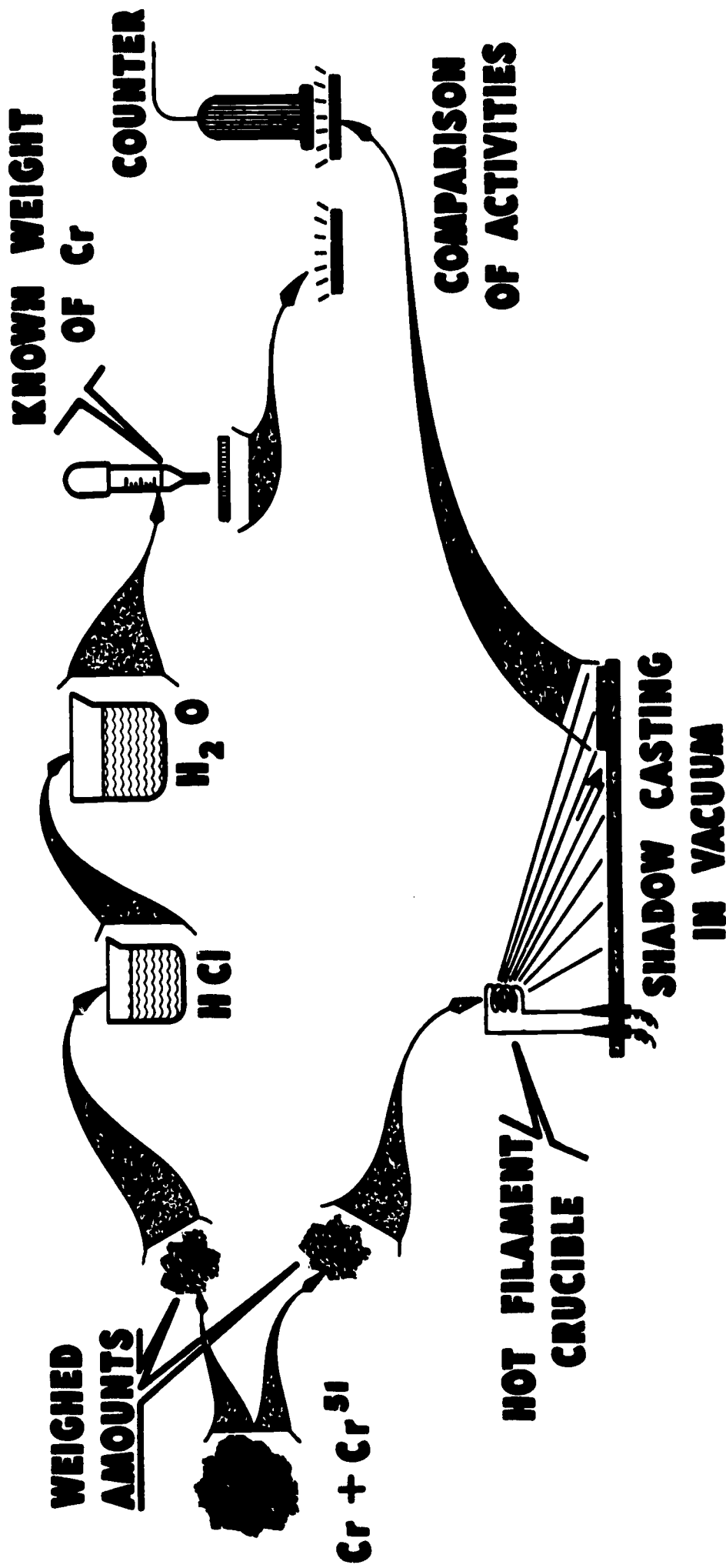

- MEASURES TO TRILLIONTH OF AN INCH
- CALIBRATES DISTRIBUTION FROM CRUCIBLE

USAEC-ID-223A

**ILLUSTRATIONS OF ISOTOPE APPLICATIONS
IN INDUSTRY**

RADIOACTIVE COBALT - Co 60 FOR LIQUID LEVEL GAGE

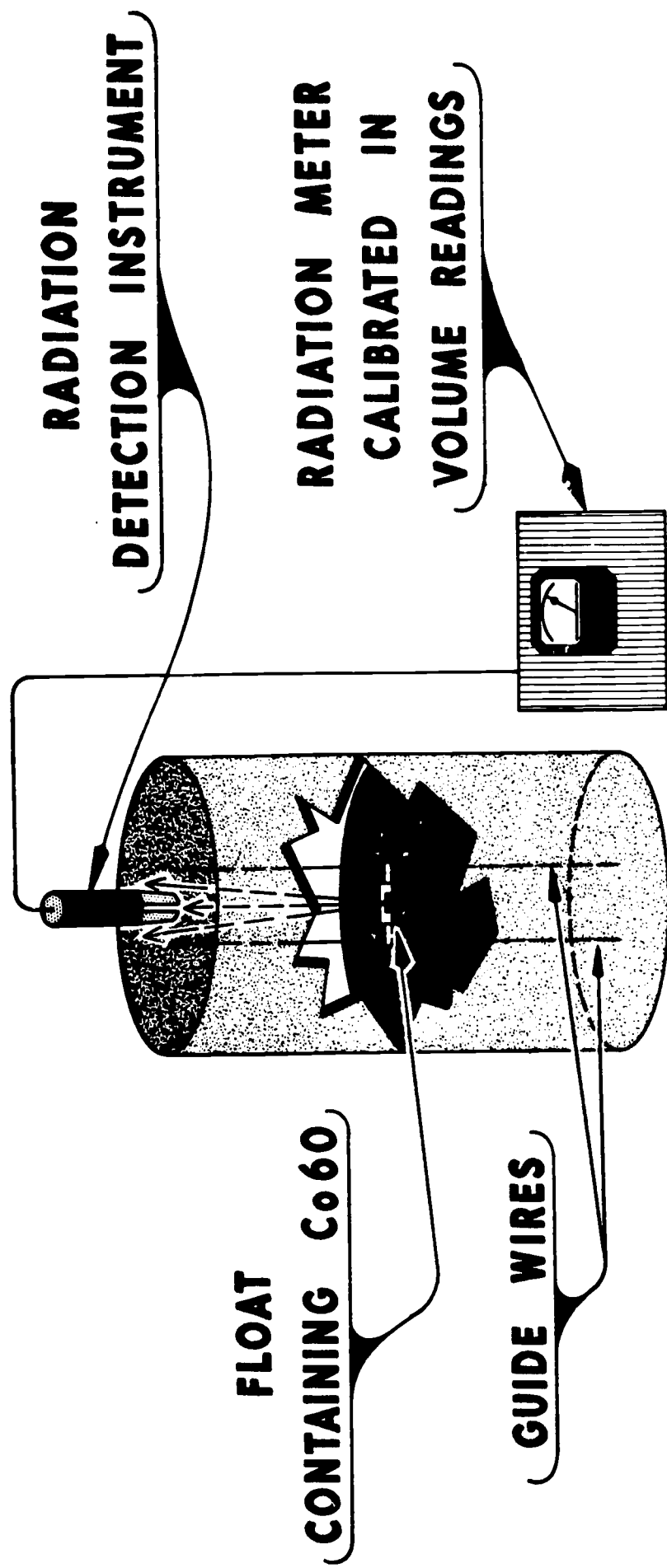

ADVANTAGES:

- 1 - CONTINUOUS RECORDING**
- 2 - MEASUREMENT MADE ON CLOSED SYSTEM**
- 3 - ADAPTABLE TO AUTOMATIC CONTROL**

RADIOACTIVE ISOTOPES FOR TRACING OIL FLOW IN PIPE LINES

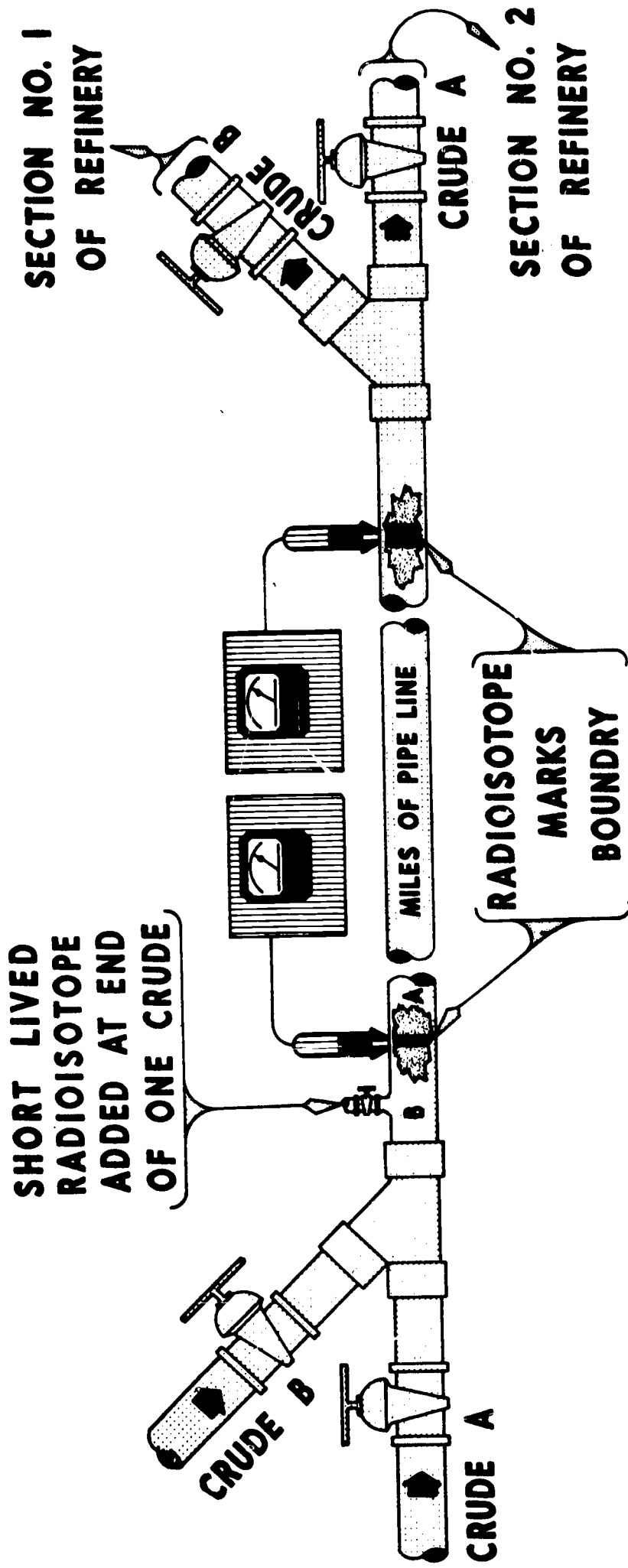

ADVANTAGES:

- 1- RADIOACTIVE "MARKER" CAN BE TRACED OVER LONG DISTANCE
- 2- "MARKER" SPREADS TO ONLY SMALL OIL VOLUME
- 3- PERMITS SEPARATION OF CRUDES WITH MINIMUM OF LOSS
- 4- METHOD QUICK AND REQUIRES NO SAMPLING

USAEC-1D-208

RADIOACTIVE ISOTOPES FOR STUDYING SOLID DIFFUSION

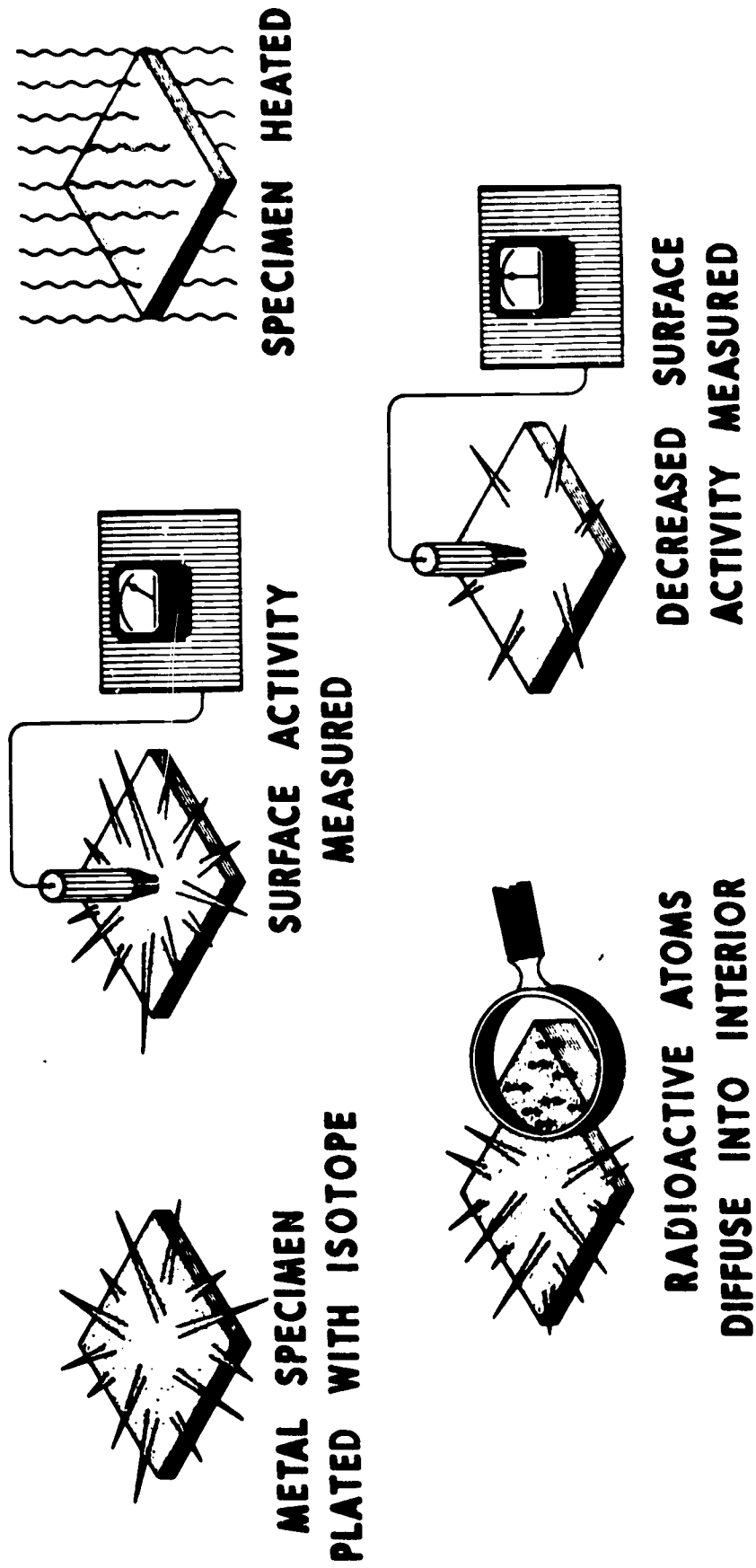

ADVANTAGES:

- 1 - GIVES ACCURATE MEASURE OF RATE AND AMOUNT OF DIFFUSION**
- 2 - QUICKER AND MORE RELIABLE THAN OTHER METHODS**
- 3 - ONLY METHOD SPECIFIC ENOUGH TO MEASURE SELF-DIFFUSION**

USAEC-10-210

RADIOACTIVE SOURCE FOR REFLECTION (BACKSCATTERING) THICKNESS GAGE

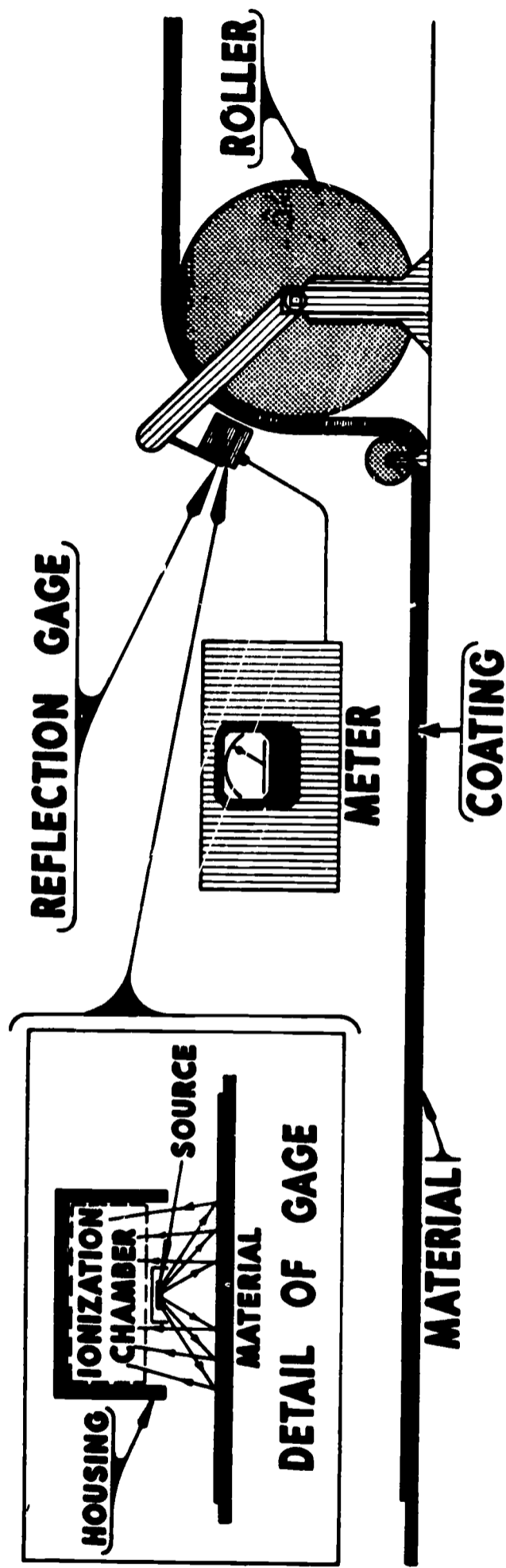

ADVANTAGES:

- 1- CAN MEASURE THICKNESS OF COATING AND/OR MATERIAL**
- 2- MEASUREMENT MADE FROM ONE ACCESSIBLE SIDE**
- 3- CAN MEASURE A VARIETY OF MATERIALS WITH ONE CALIBRATION**

USAEC-1D-220

RADIOACTIVE COBALT - Co60

FOR INDICATING LIQUID HEIGHT

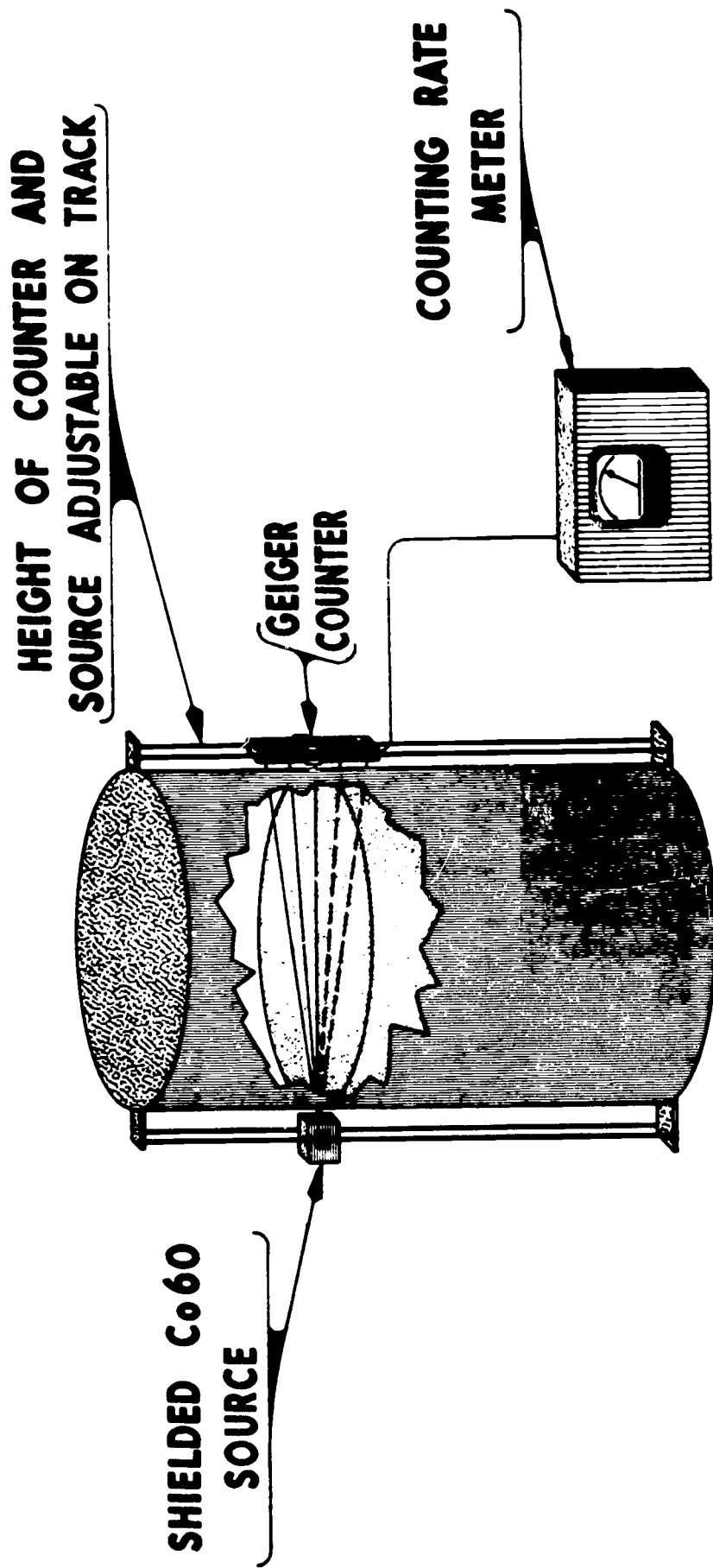

ADVANTAGES:

- 1 - GAGE NOT AFFECTED BY CORROSION AND TEMPERATURE
- 2 - CAN BE OPERATED BY NON-TECHNICAL PERSONNEL
- 3 - ADAPTABLE TO AUTOMATIC RECORDING AND CONTROL OF LIQUID LEVEL

USAEC-1D-284

RADIOISOTOPES IN INDUSTRY

FIXED SOURCE [MEASURE CHANGE IN RADIATION INTENSITY]

RADIOGRAPHY
THICKNESS GAGE
LIQUID LEVEL GAGE
DENSITY METER

MOVABLE SOURCE [LOCATE OR FOLLOW MARKED OBJECT]

LIQUID FLOW THROUGH PIPE
LOCATION OF "GO DEVIL"

TRACER [PHYSICAL TRANSFER]

FRICITION WEAR
SOLID DIFFUSION

TRACER [PHYSICAL - CHEMICAL TRANSFER]

DETERGENCY
MINERAL FLOTATION
MOVEMENT OF PRESERVATIVE

TRACER [MECHANISM OF REACTION]

ROLE OF CATALYSTS
FISCHER - TROPSCH SYNTHESIS
SOURCE OF COKE SULFUR

RADIOACTIVE CALCIUM - Ca 45

FOR TESTING PAVING ASPHALTS

RADIOACTIVE CaCl_2
PUT ON STONE
PRIOR TO COATING
WITH ASPHALT

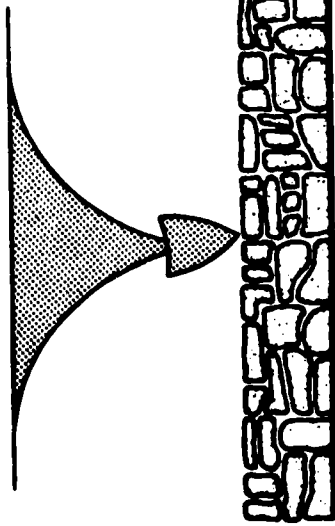

ASPHALT COATED
STONE SPRAYED
WITH WATER

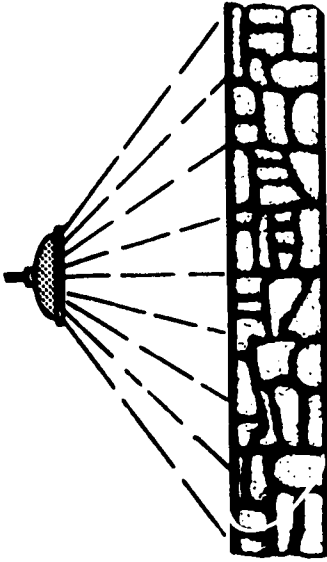

RADIOACTIVITY OF
WATER MEASURED

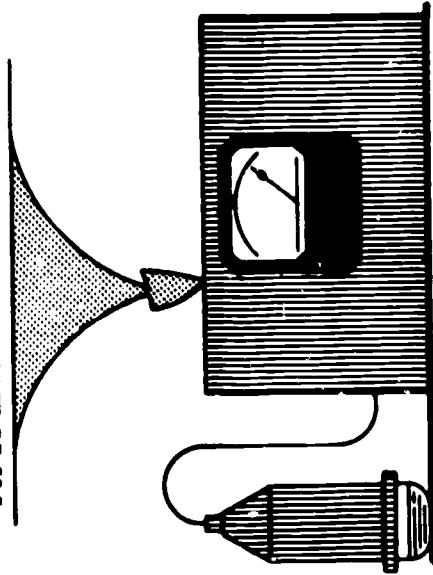

INDICATES

- 1 - BONDING BETWEEN ASPHALT AND STONE
- 2 - DURABILITY OF ROAD MATERIALS
- 3 - BLENDS FOR BETTER PAVING

RADIOACTIVE ISOTOPES FOR CONTROL OF OIL WELL ACIDIZING

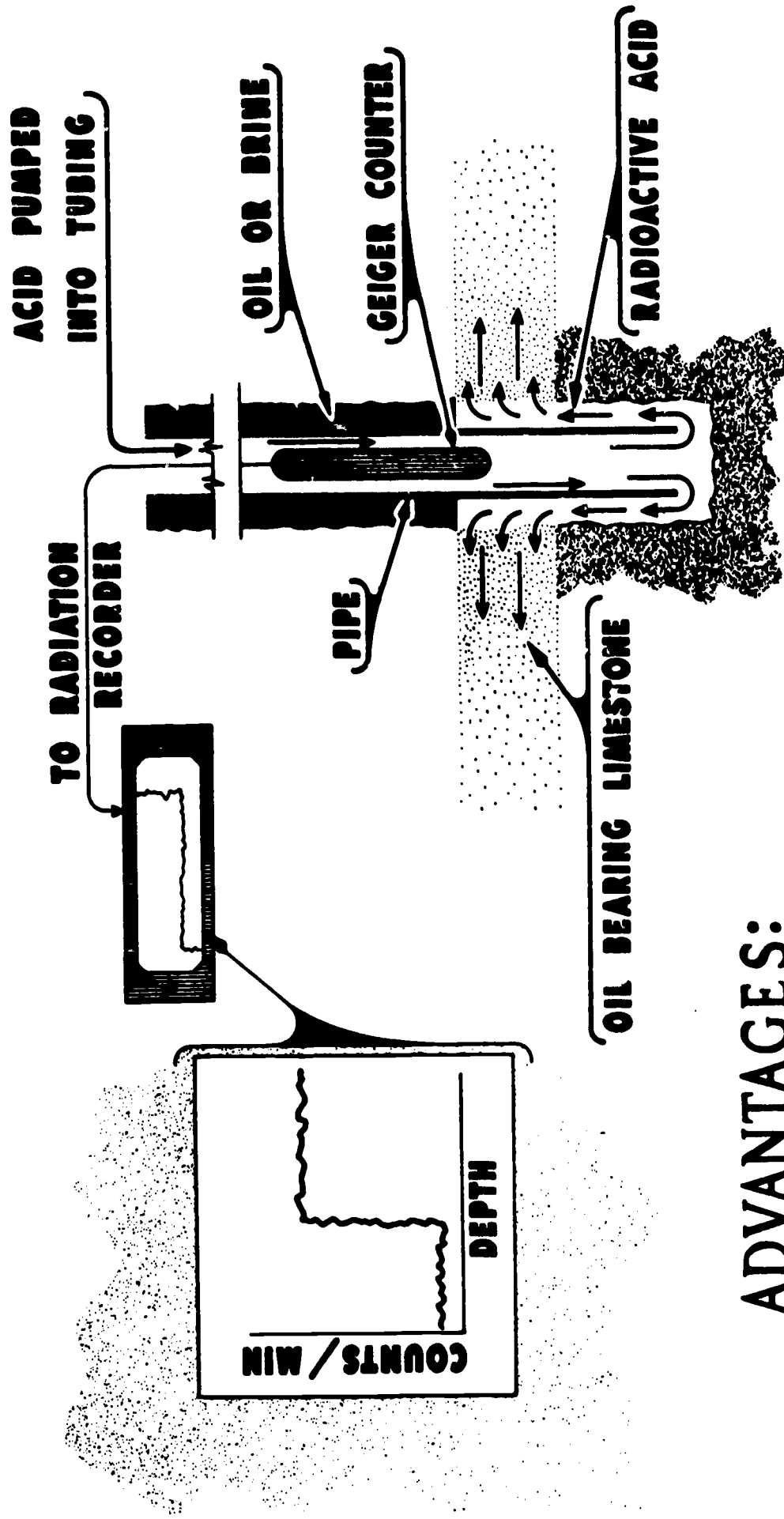

ADVANTAGES:

- 1 - PERMITS CONTROLLING SITE OF ACID ACTION
- 2 - INCREASES EFFICIENCY OF OIL PRODUCTION
- 3 - SAVES TIME AND MONEY
- 4 - LESS HAZARDOUS THAN REMOVING PIPE

USAEC-ID-3A

RADIOACTIVE ISOTOPES FOR TESTING WEAR RESISTANCE OF FLOOR WAX

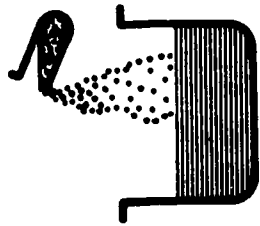

①

ADD RADIOACTIVE
COMPOUND TO WAX

② APPLY WAX TO
LINOLEUM AND
MEASURE ACTIVITY

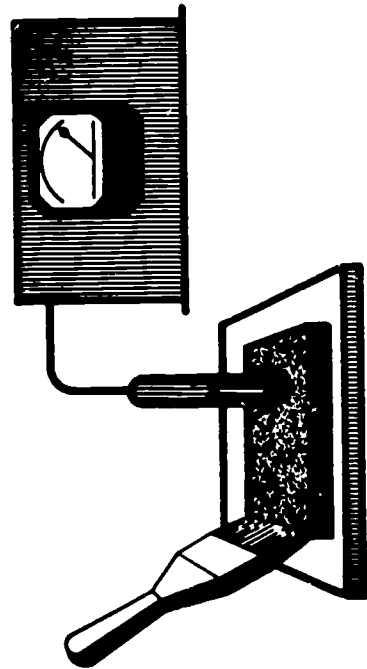

③ SUBJECT WAX
TO WEAR AND
MEASURE ACTIVITY

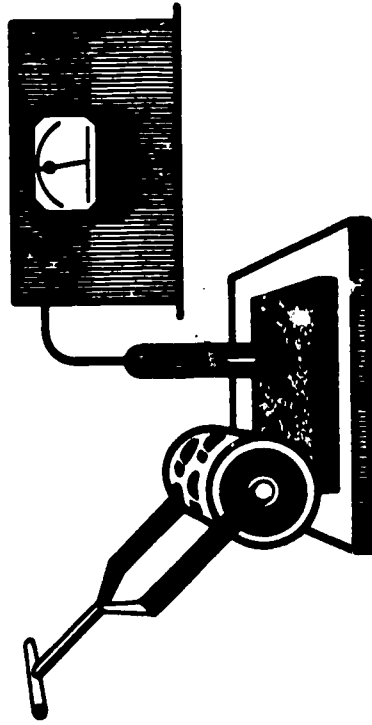

ADVANTAGES

- 1 - QUANTITATIVE MEASUREMENT OF WEAR
- 2 - MEASURES EARLY PHASES OF WEAR
- 3 - MEASURES EXTREMELY MINUTE AMOUNTS

USAEC-ID-4A

RADIOACTIVE COBALT - Co 60

FOR MEASURING WATER CONTENT OF SNOWFALL

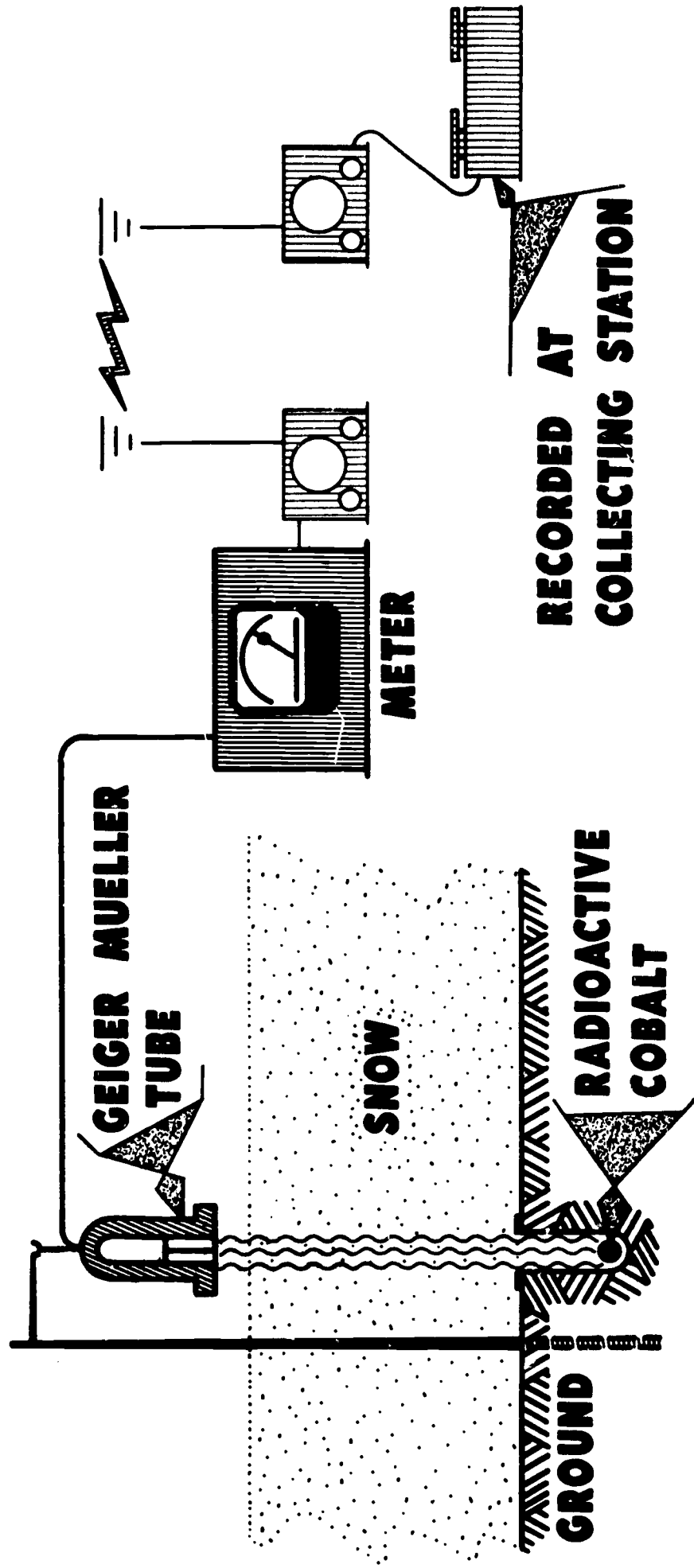

ADVANTAGES:

- 1 - MEASURES AMOUNT OF WATER DIRECTLY**
- 2 - MEASUREMENTS TAKEN REMOTELY**
- 3 - HIGHER DEGREE OF ACCURACY**

USAEC-ID-7A

RADIOACTIVE IODINE - I-131 FOR DETECTING LEAKS IN WATER LINES

POUR RADIOACTIVE
IODINE INTO
WATER LINE

RADIOACTIVITY MEASURED
INDICATES LOCATION OF
IODINE FORCED THRU PIPE

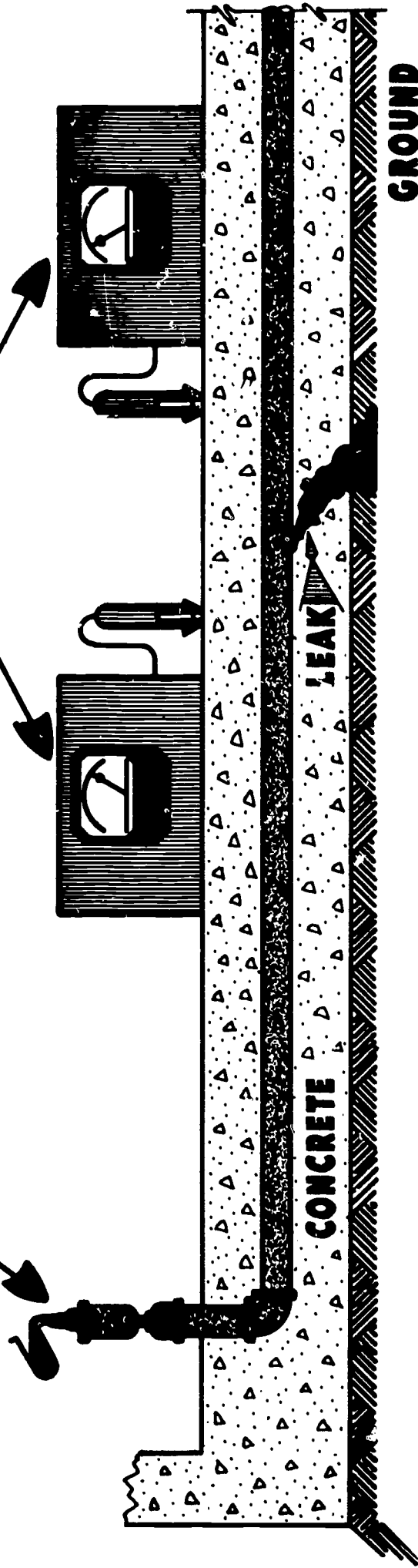

ADVANTAGES:

- 1 - NOT NECESSARY TO REMOVE FLOORS
- 2 - LESS COSTLY AND MORE CONVENIENT
- 3 - SHORT HALF-LIFE --- NO RESIDUAL ACTIVITY

USAEC-ID-6A

TEST FOR WASHING EFFICIENCY USING RADIOACTIVE PHOSPHORUS - P32

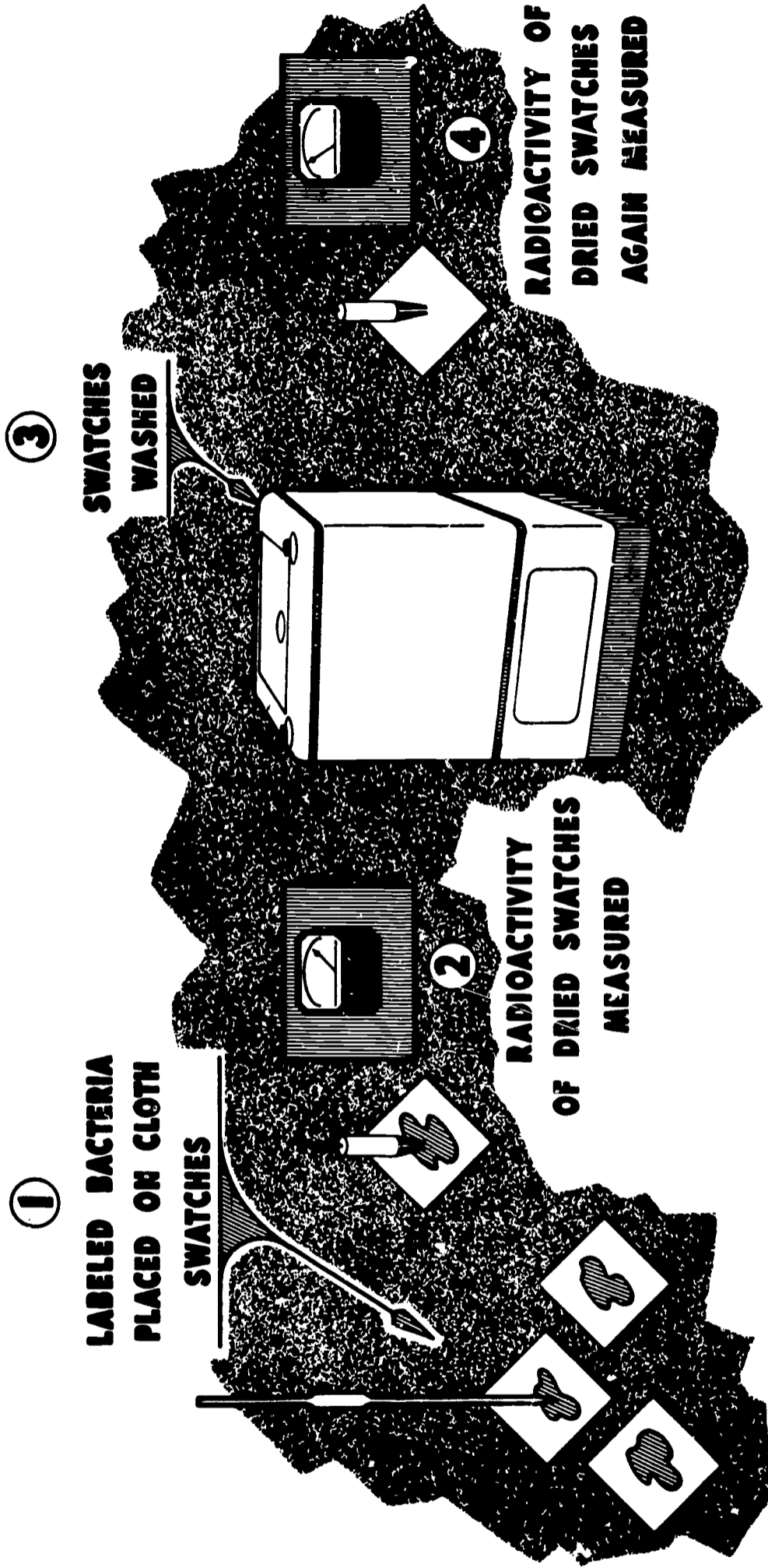

SHOWS:

- 1 - EFFICIENCY OF WASHING PROCEDURES FOR REMOVING BACTERIA
- 2 - COMPARATIVE EFFICIENCIES OF VARIOUS DETERGENTS
- 3 - AMOUNT OF CROSS CONTAMINATION

TEST ON COTTON DETERGENCY

WITH

RADIOACTIVE CALCIUM - Ca^{45}

①

DETERGENT AND
LABELED CALCIUM
BICARBONATE ADDED
TO WASH WATER

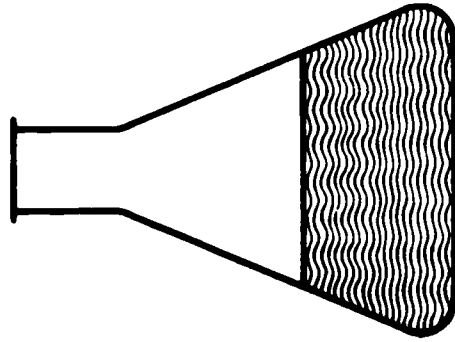

②

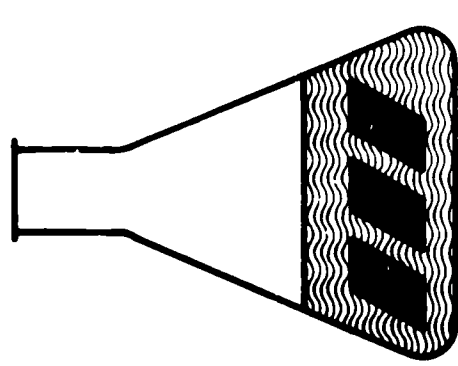

COTTON SWATCHES
INTRODUCED

③

SWATCHES WASHED
WITH HEAT AND
AGITATION APPLIED

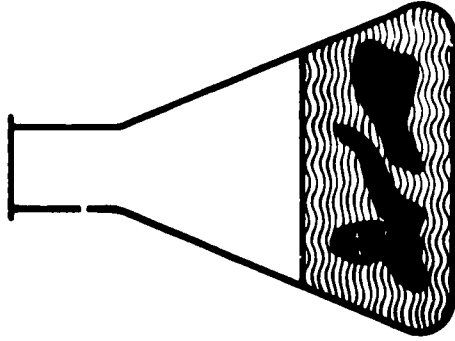

④

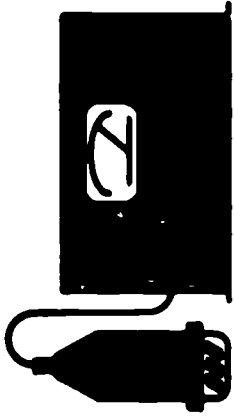

RADIOACTIVITY OF
RINSED AND DRIED
SWATCHES MEASURED

INDICATES:

- 1 - AMOUNT OF CALCIUM ADSORBED ON CLOTH
- 2 - CALCIUM ADSORPTION DEPENDS ON TYPE OF DETERGENT
- 3 - CORRELATION BETWEEN CALCIUM UPTAKE AND DETERGENT ACTION

USAEC-ID28A

RADIOACTIVE ISOTOPES FOR DETERMINING THOROUGHNESS OF MIXING

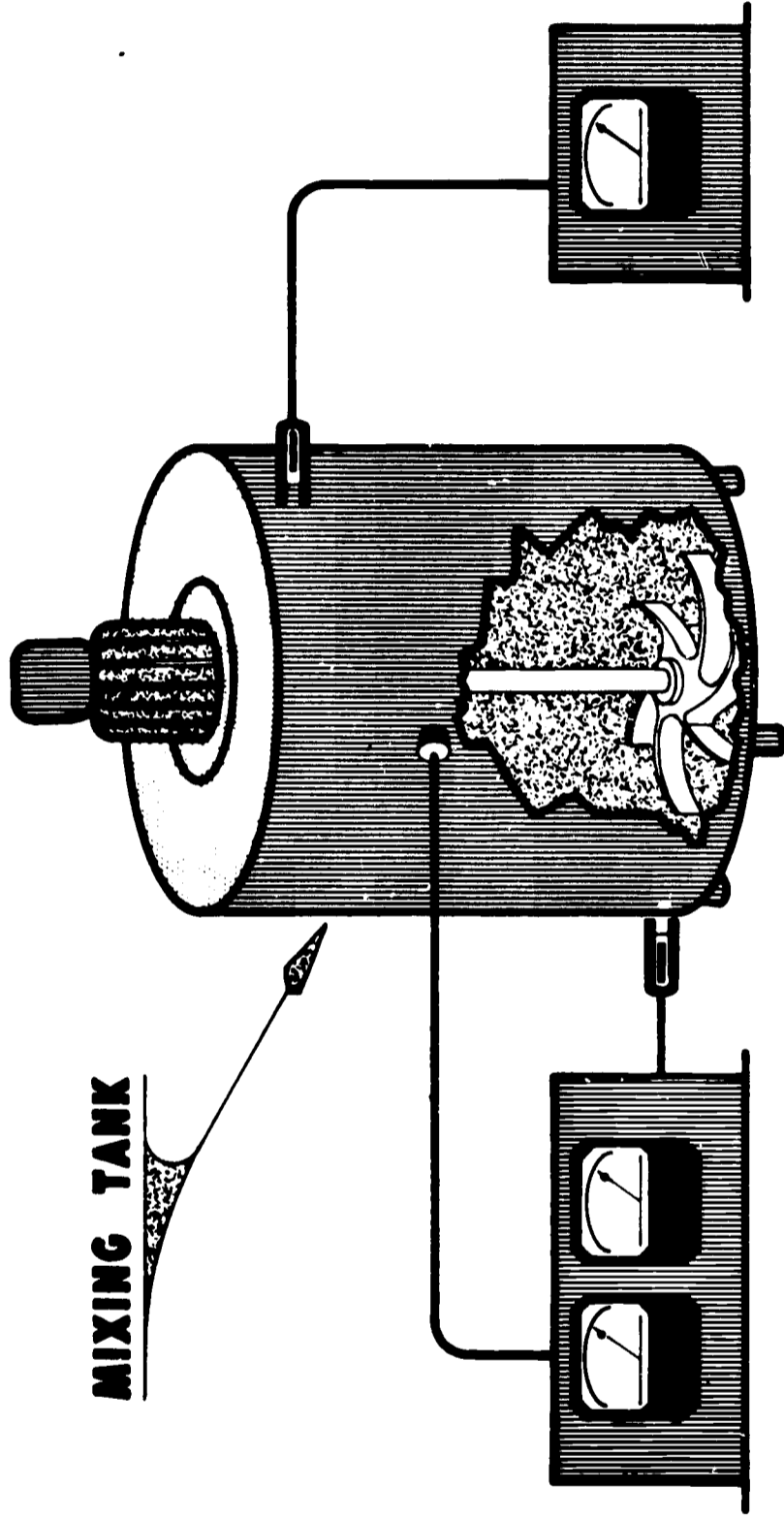

ADVANTAGES:

- 1 - UNIFORMITY OF MIXING EASILY ASSURED**
- 2 - EXCESSIVE MIXING TIME ELIMINATED**

USAEC-ID-34A

SOME USES OF FISSION PRODUCTS

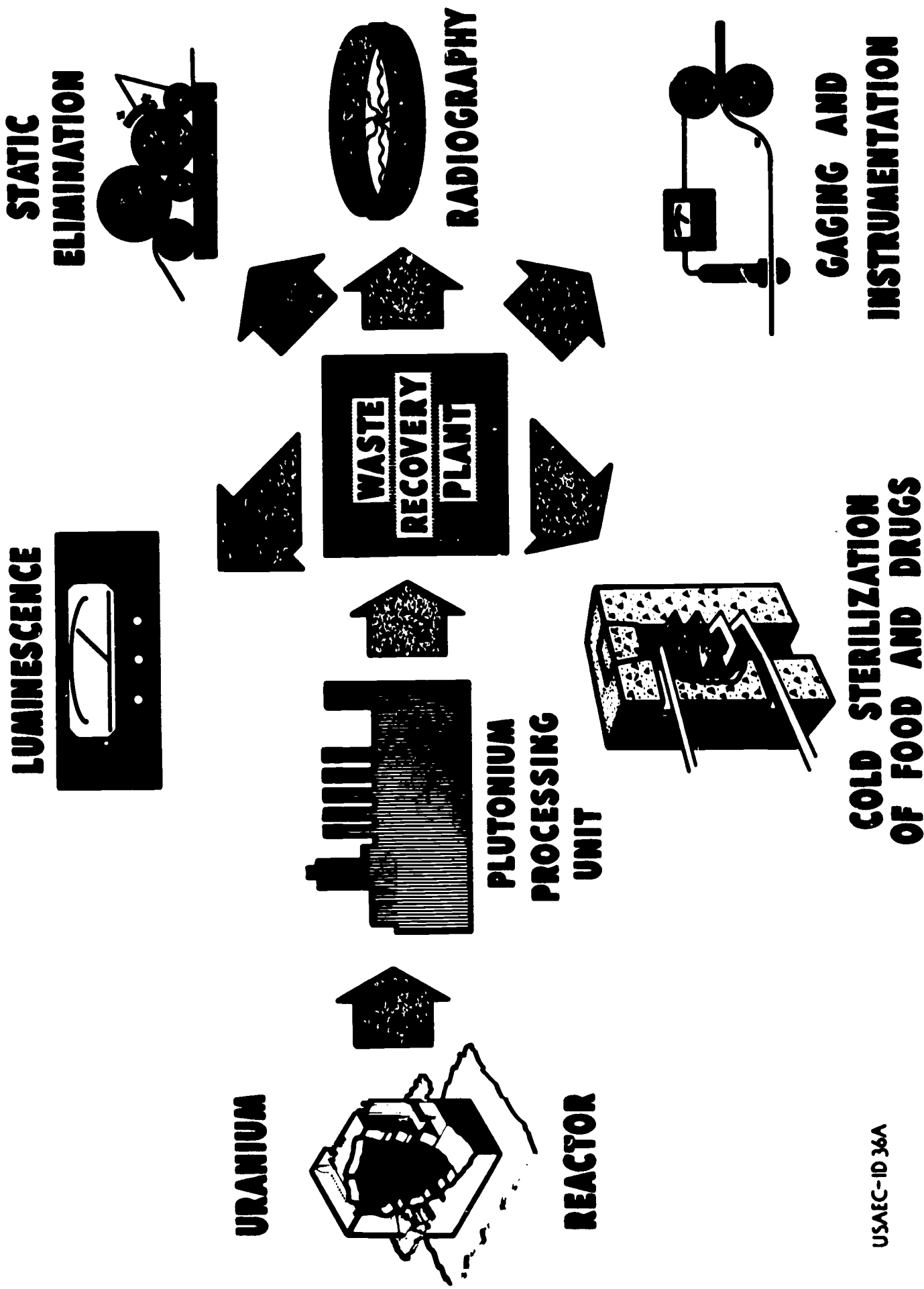

USAEC-ID 36A

LOCATING LEAKS IN UNDERGROUND CONDUITS

WITH
RADIOACTIVE CARBON — C14

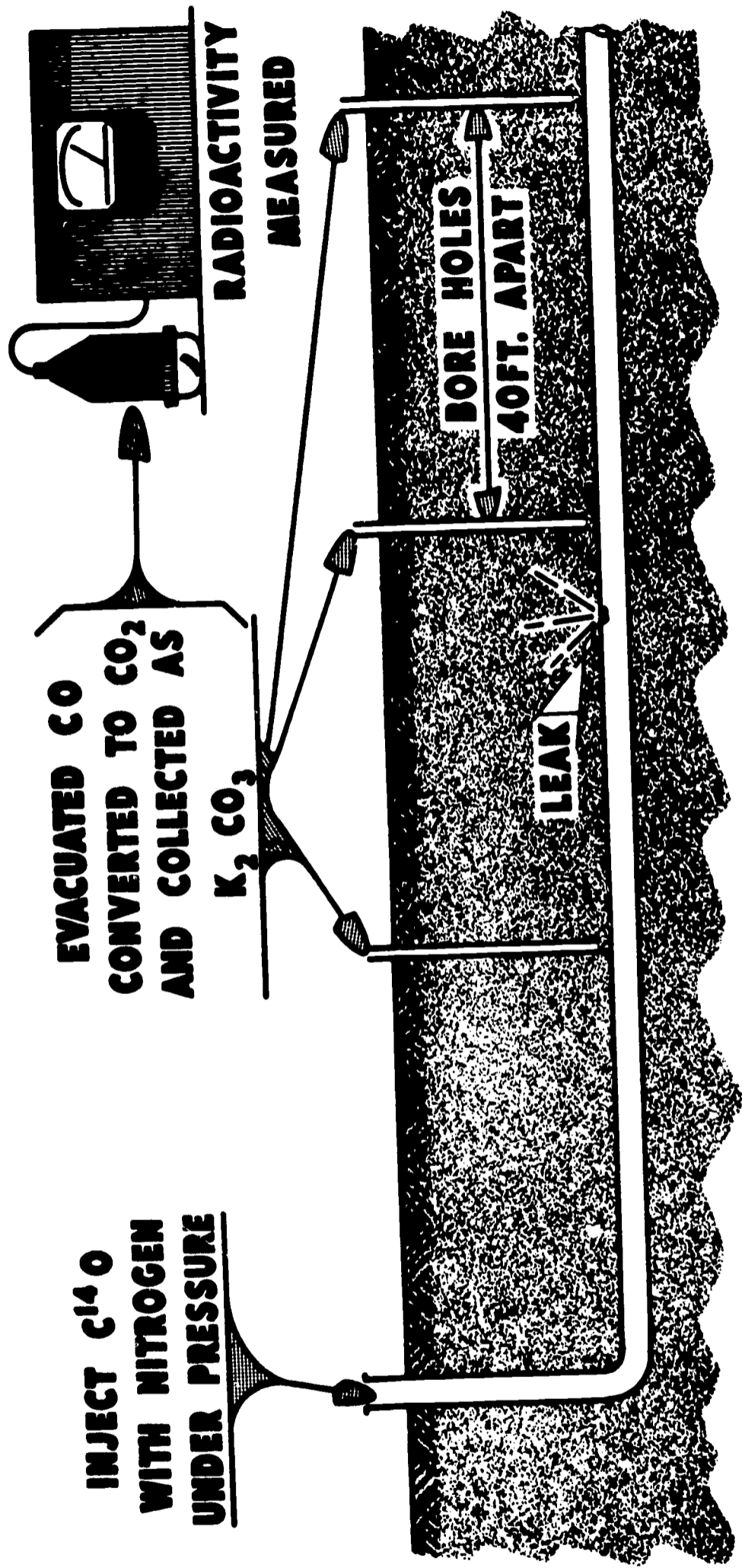

- ADVANTAGES:**
- 1—GREAT SENSITIVITY**
 - 2—SIMPLE AND INEXPENSIVE**
 - 3—NO INTERRUPTION TO NORMAL SERVICE**

USAEC-ID 41A

MEASURING THICKNESS AND DEFECTS OF METAL CASTINGS WITH RADIOISOTOPES

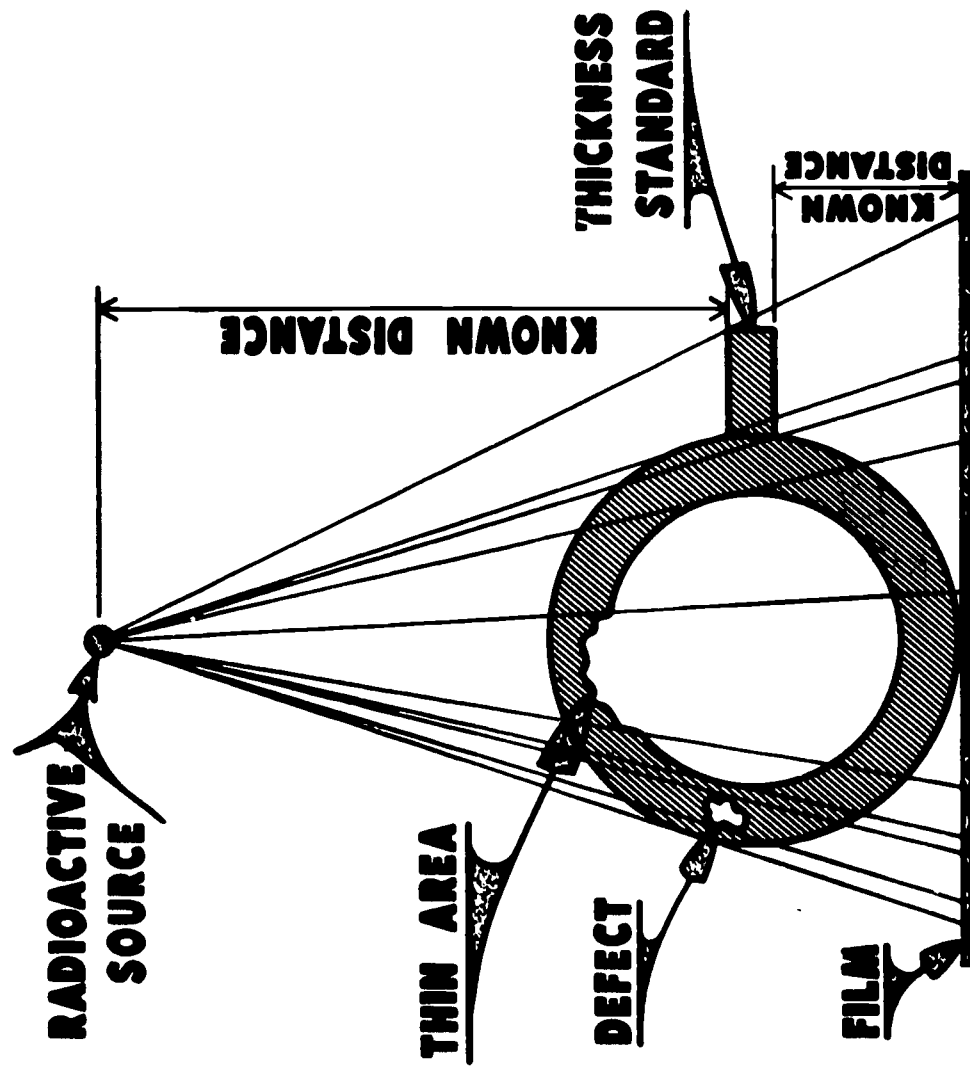

RADIOGRAPH

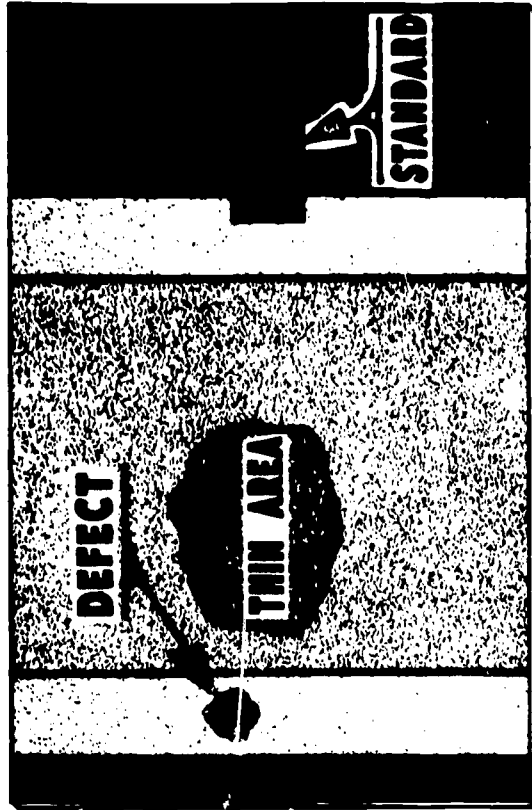

DEVELOPED FILM

ADVANTAGES: 1 - VERSATILE AND RELIABLE INSPECTION

2 - INSPECTION MADE WITHOUT DISMANTLING

3 - VERY HIGH ACTIVITY SOURCES AVAILABLE AT LOW COST

USAEC-ID-59A

RADIOACTIVE IRON - Fe 59

FOR FRICTION AND LUBRICATION STUDIES

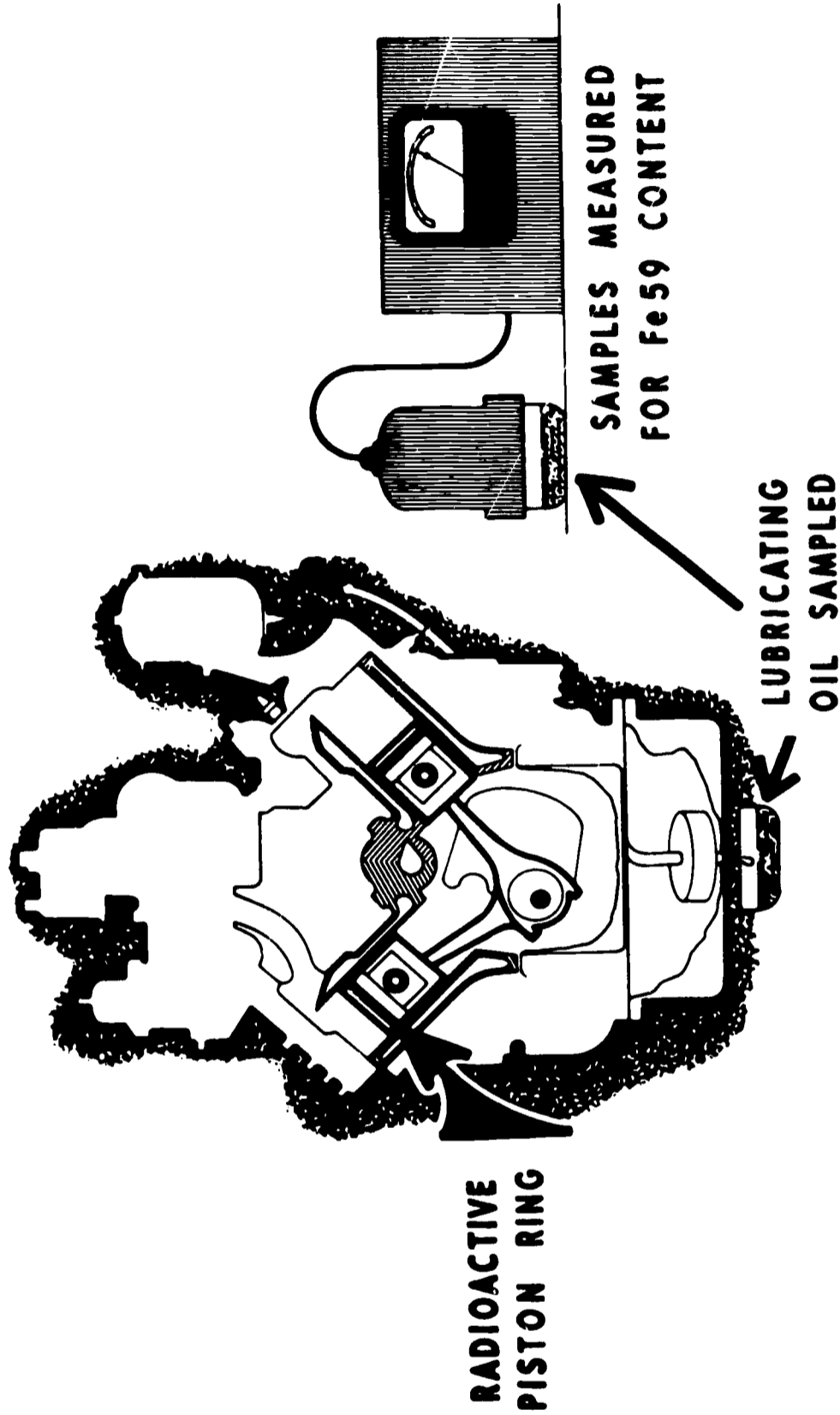

ADVANTAGES:

- 1 - TRANSFER OF METAL MEASURED TO $\frac{1}{100,000}$ OUNCE
- 2 - OIL SAMPLED DURING OPERATION OF MOTOR
- 3 - RAPID - SIMPLE - ECONOMICAL

USAEC-10-68A

RADIOACTIVE SOURCE FOR GAGING THICKNESS

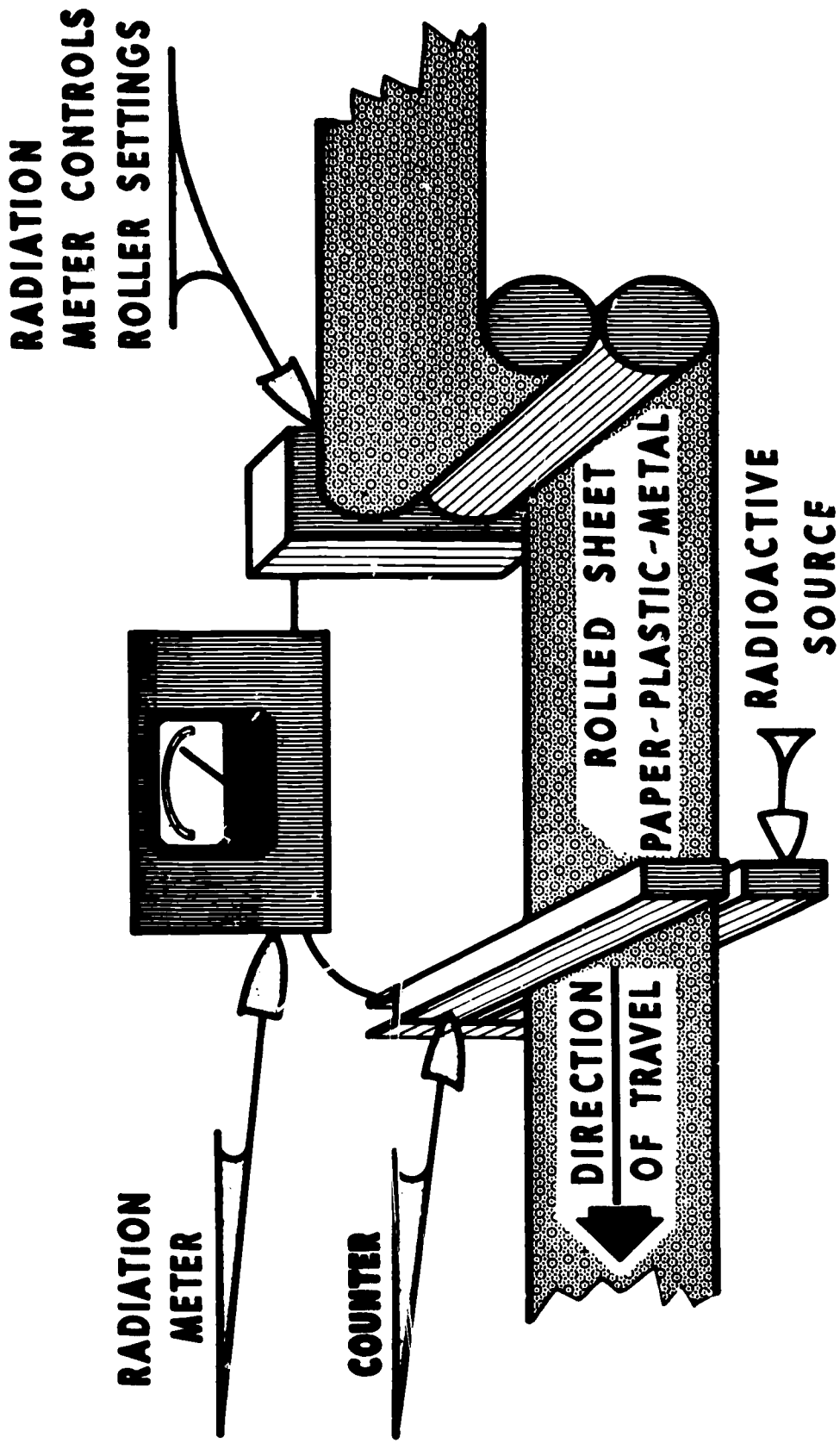

ADVANTAGES:

- 1- RADIATION SOURCE SELECTED TO SUIT MATERIAL
- 2- NO CONTACT - NO TEARING - NO MARKING MATERIAL
- 3- RAPID AND RELIABLE

USAEC-1D-68A

MEASURING CUTTING TOOL WEAR AND LIFE

BY RADIOACTIVITY TESTS

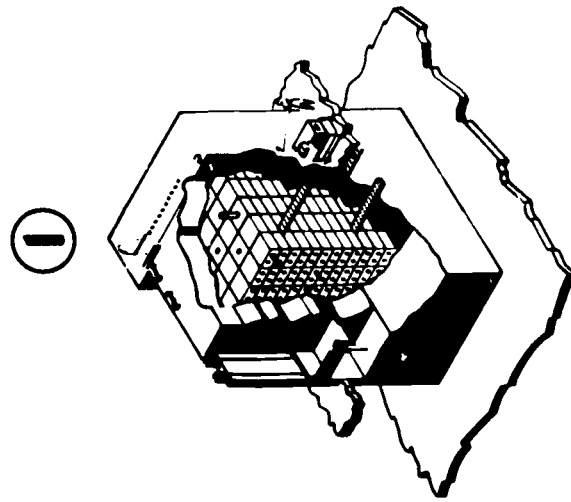

**CUTTING TOOL
IRRADIATED IN
NUCLEAR REACTOR**

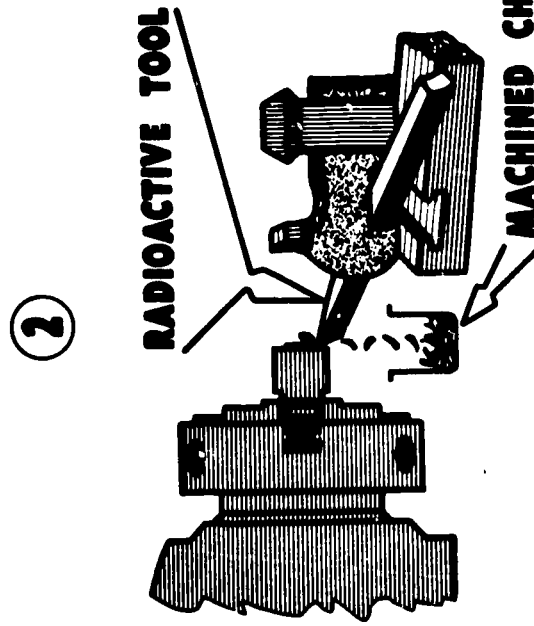

**RADIOACTIVE TOOL
USED FOR MACHINING**

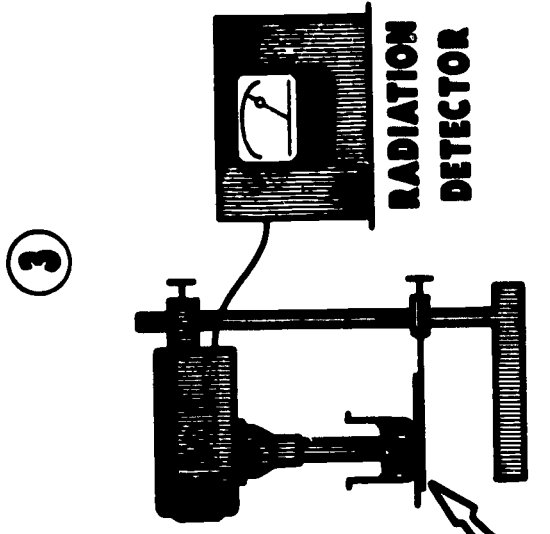

**MACHINED CHIPS
MEASURED FOR
RADIOACTIVITY**

ADVANTAGES:

- 1-MORE REPRODUCIBLE AND SENSITIVE THAN OTHER TESTS**
- 2-FASTER AND MORE EFFICIENT**
- 3-YIELDS KNOWLEDGE OF WEAR PROCESS**

USAEC-D-87A

DETECTION OF DYE MIGRATION **WITH** **RADIOACTIVE PHOSPHORUS - P³²**

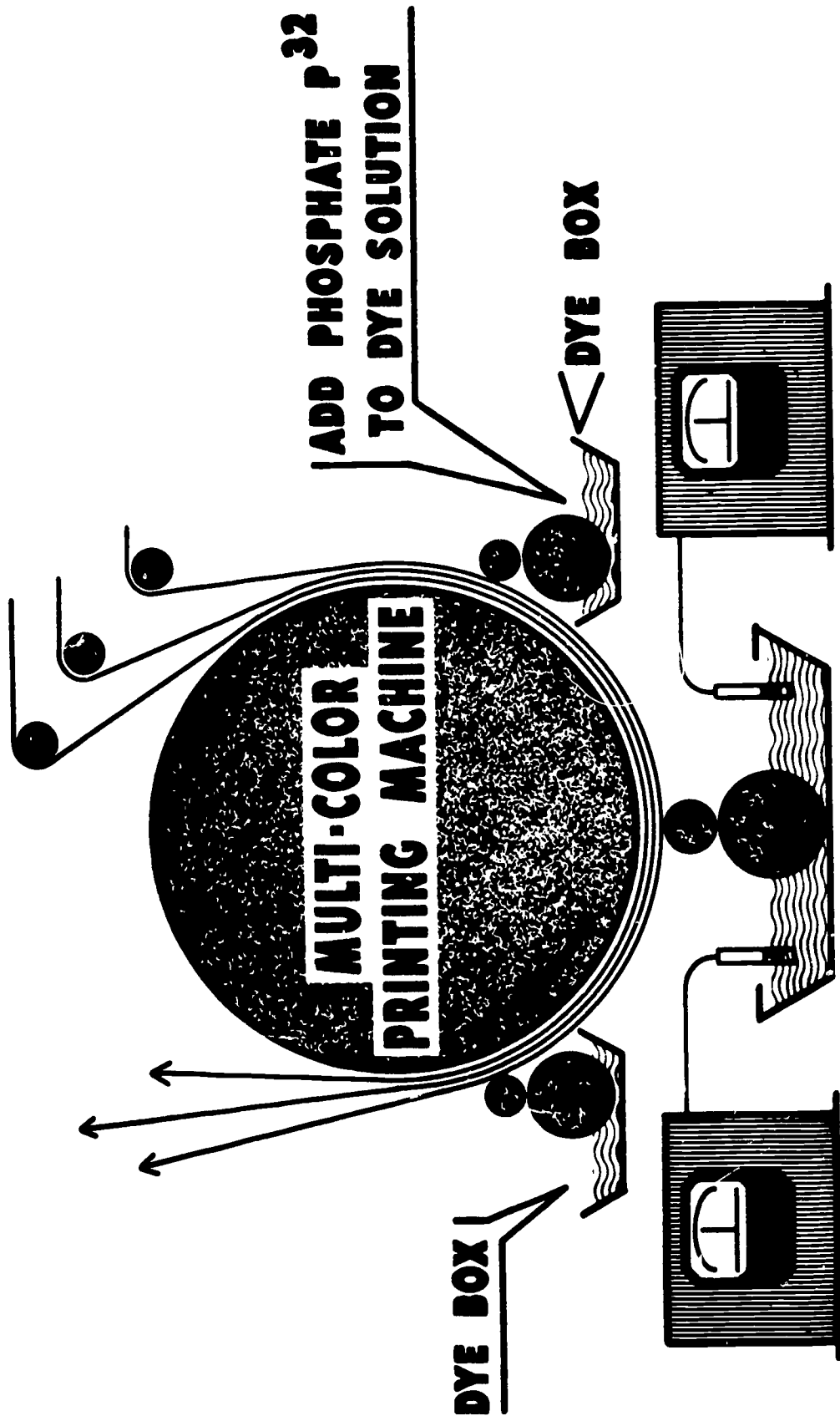

USAEC-ID-103A

USE OF MULTIPLE BETA GAGES

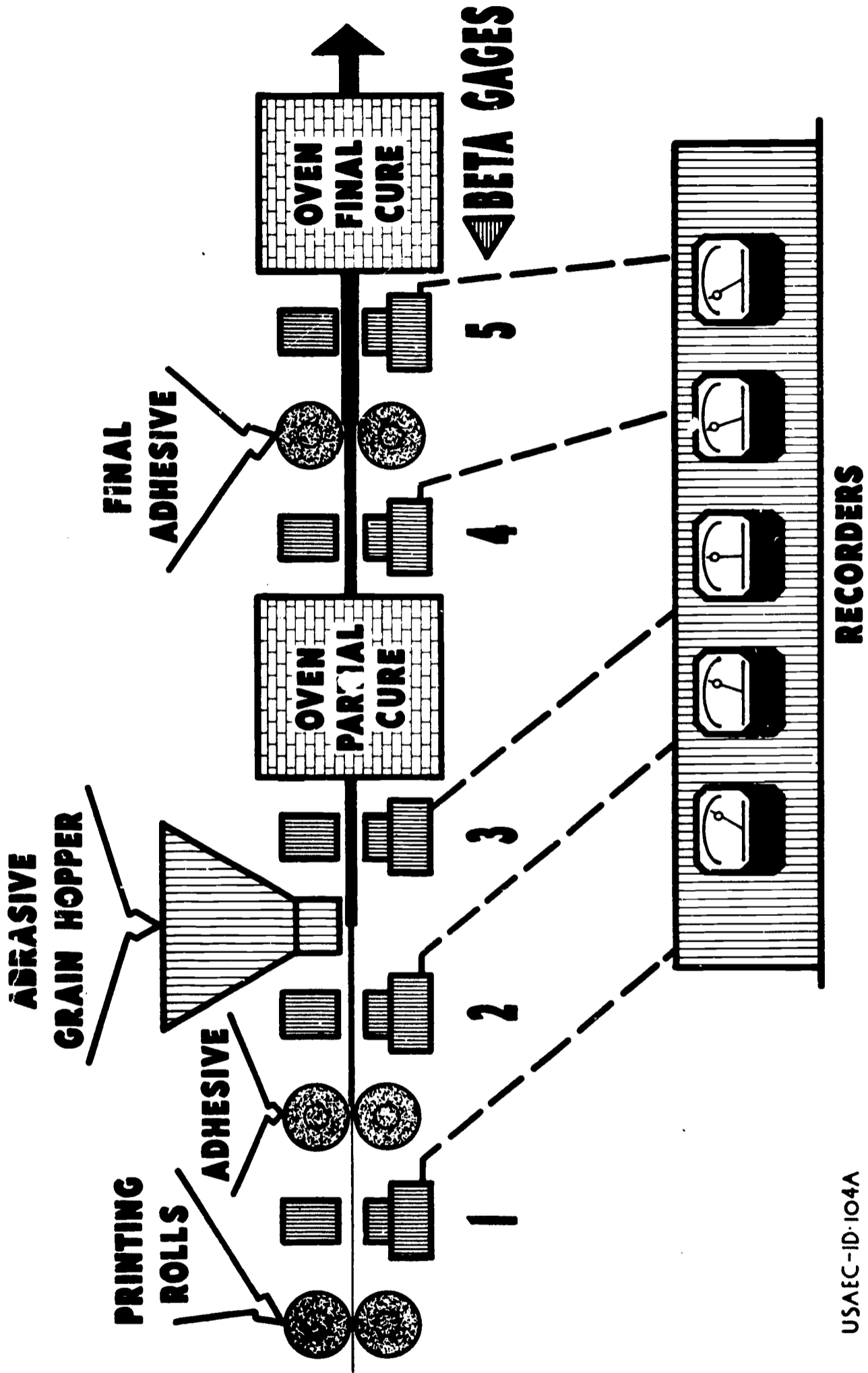

USAEC-ID-104A

CONTROL OF CATALYST FLOW RATE USING RADIOACTIVE BEADS

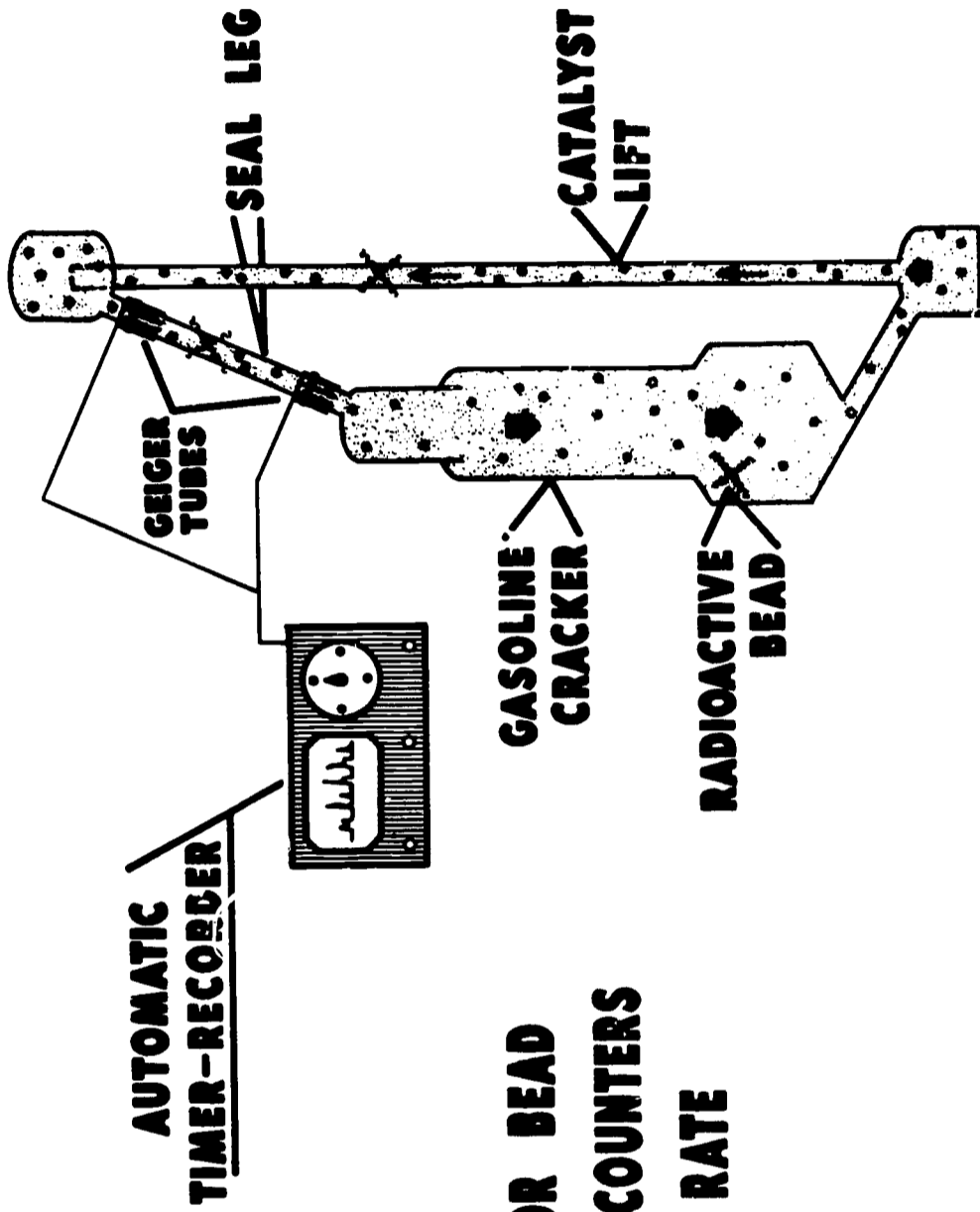

**TIME REQUIRED FOR BEAD
TO PASS BETWEEN COUNTERS
MEASURES FLOW RATE**

ADVANTAGES:

- 1—IMMEDIATE INDICATION OF IMPROPER OPERATION**
- 2—NO INTERFERENCE WITH PRODUCTION**
- 3—POSSIBLE AUTOMATIC ADJUSTMENT OF FLOW RATE**

USAEC-ID-147A

ISOTOPES FOR RADIOGRAPHY

<u>ISOTOPE</u>	<u>HALF-LIFE</u>	<u>PRINCIPAL GAMMA RAY ENERGIES - Mev</u>	<u>APPROX. SPEC. ACT.</u>	<u>APPROX. X-RAY OUTPUT/CURIE r/hr/ft</u>	<u>TYPE OF USE</u>
Co 60	5.3y	1.1, 1.3	7 c/g - NOW 35 c/g - 1954	14.4	HEAVY CASTINGS THICK WELDMENTS
Ta 182	117d	1.1, 1.2	1.5 c/g GREATER IF NEEDED	6.7	HEAVY CASTINGS THICK WELDMENTS
Cs 137	37y	0.66	20 c/g - 1955 (Cs ₂ SO ₄)	3.5	—
Ir 192	75d	0.3, 0.5	2.5 c/g - NOW 30 c/g - 1954	3.0	PIPE LINES LIGHT ALLOYS THIN SECTIONS
Tm 170	127d	0.085	SERVICE IRRADIATION	—	LIGHT ALLOYS THIN SECTIONS

USAEC-ID-149A

MEASURING WEAR OF FIREBRICK LINING

USING

RADIOACTIVE COBALT — Co60

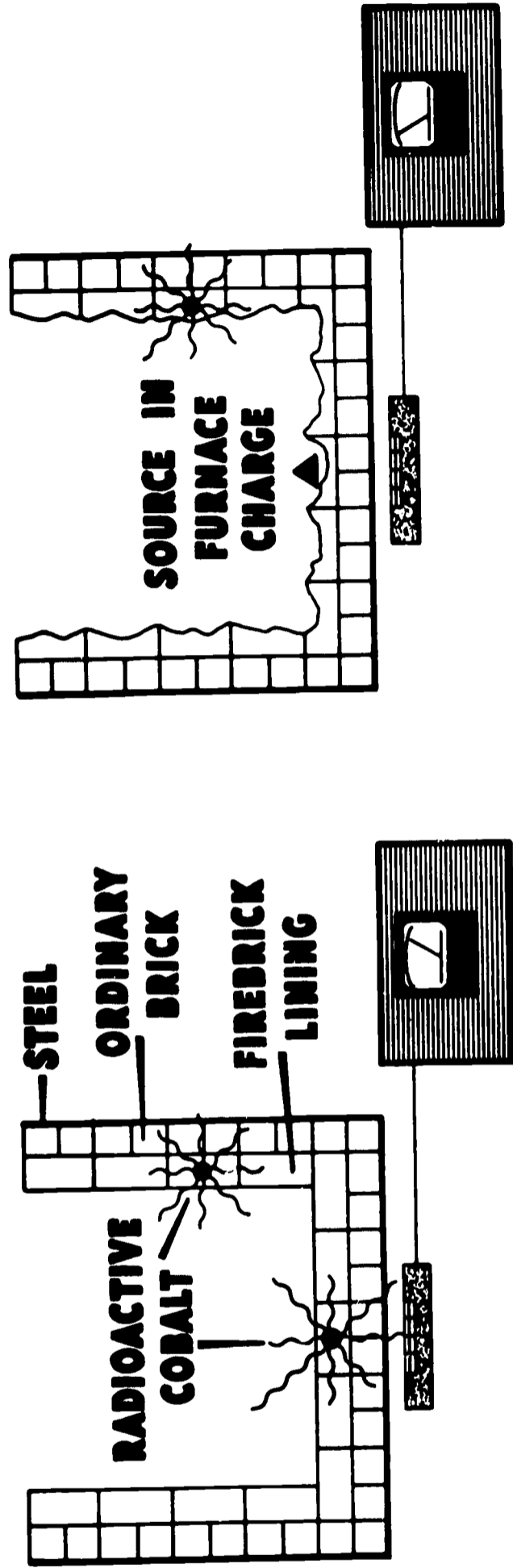

ADVANTAGES:

- PERMITS NORMAL OPERATION
- WARNS OF INCIPIENT FAILURE

USAEC-ID-217A

ELECTRON PRINTING WITH RADIOISOTOPES

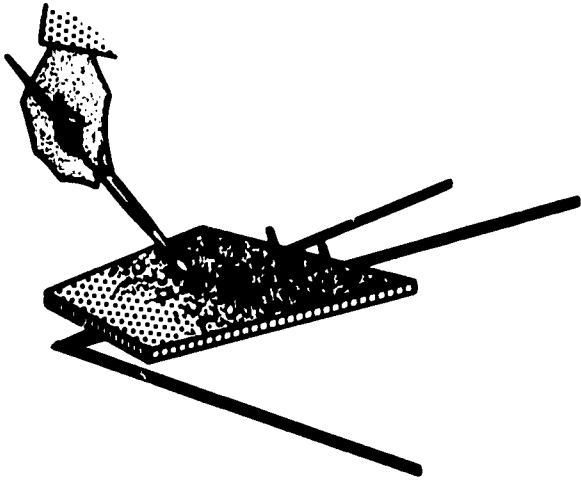

**ARTIST DRAWS, PAINTS
OR SKETCHES WITH
RADIOACTIVE INK**

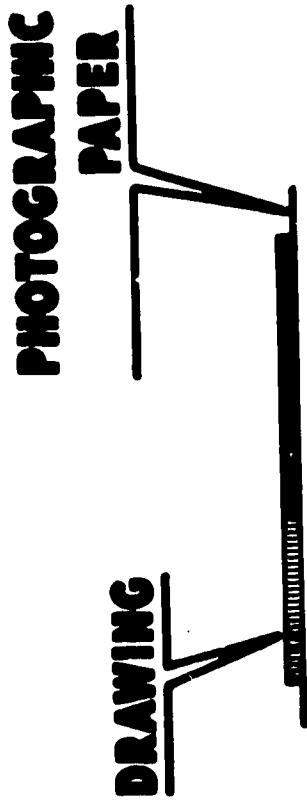

**ORIGINAL DRAWING PRESSED
AGAINST PHOTOGRAPHIC
PAPER TO MAKE COPIES**

- ADVANTAGES:**
- 1-- PRODUCES FINELY DETAILED COPIES**
 - 2-- TRUER THAN PHOTOGRAPHIC PRINT**
 - 3-- LESS COMPLICATED EQUIPMENT**
 - 4-- MORE PRECISE AND CHEAPER THAN LITHOGRAPH**

USAEC-ID-224A

GAUGING CIGARETTE FIRMNESS WITH RADIOISOTOPES

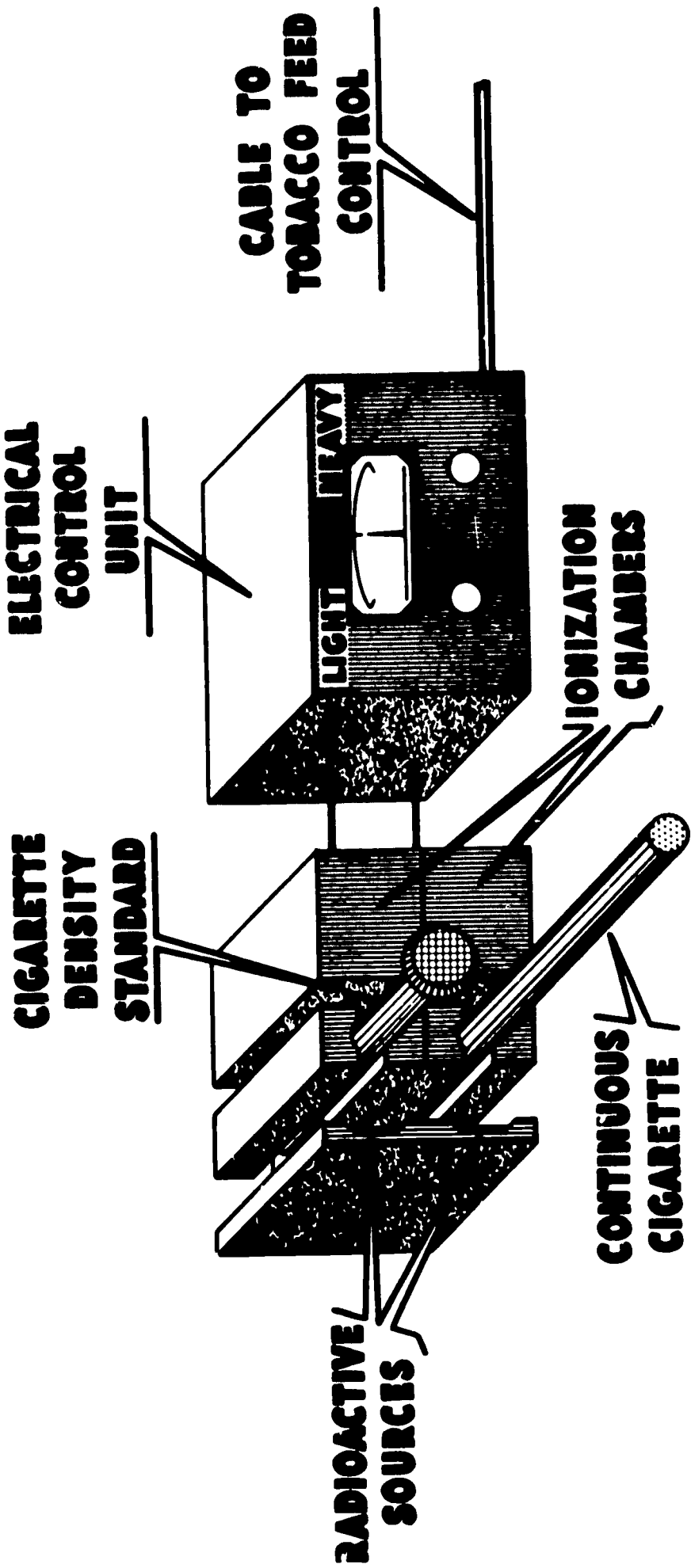

- ADVANTAGES:**
- 1 - MORE UNIFORM FIRMNESS
 - 2 - SAVES TOBACCO
 - 3 - ELIMINATES MANUAL CONTROL
- USAEC-ID-226A

Voltage Production

AN

INDUSTRIAL USE OF RADIOISOTOPES

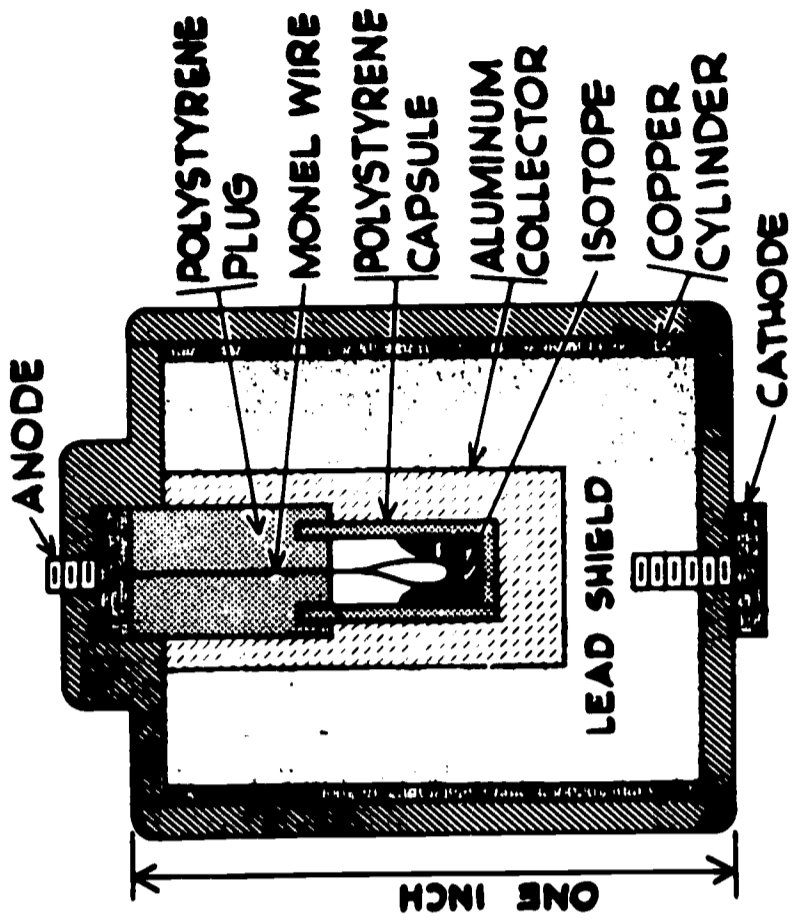
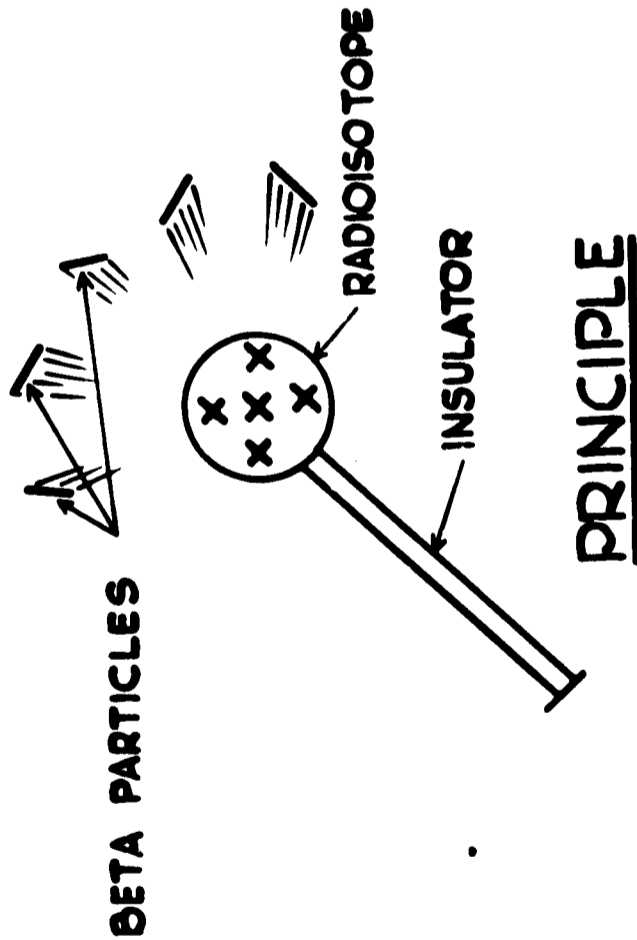

CHARACTERISTICS:

- 1 - MAXIMUM VOLTAGE UP TO 7kv
- 2 - 33% EFFICIENT
- 3 - $40\mu\mu$ AT ZERO VOLTAGE FOR 10mc Sr90
- 4 - LONG USEFUL LIFE UNDER EXTREME CONDITIONS
- 5 - SMALL - LIGHT - INEXPENSIVE

USAEC-10-266A

Ionization

INDUSTRIAL USE OF RADIOISOTOPES

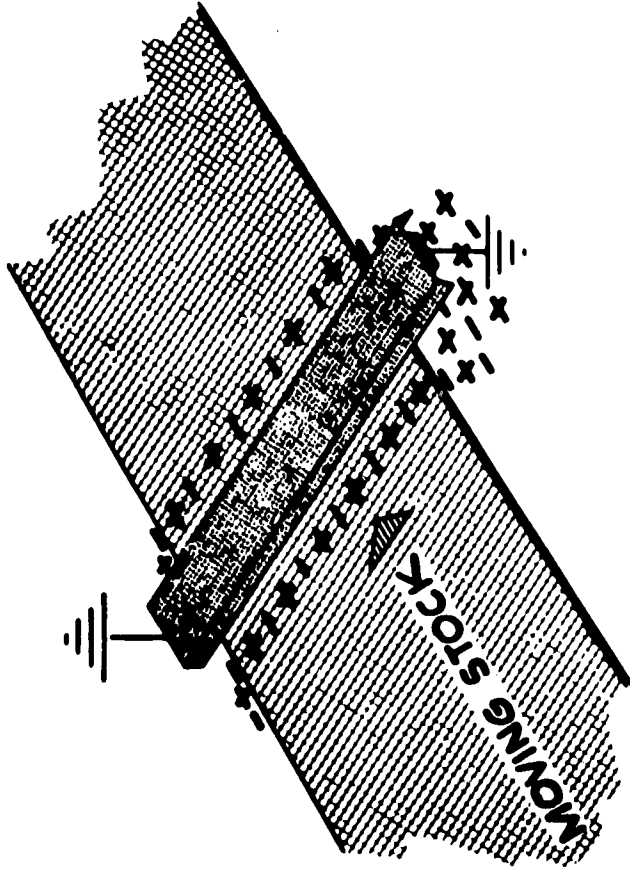

STATIC ELIMINATOR

RADIATION PRE-IONIZES
AIR PROVIDING EXIT
PATH FOR STATIC

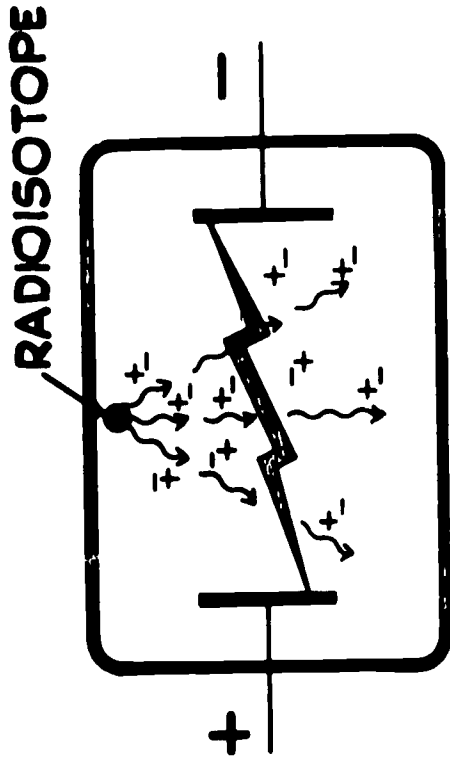

ELECTRON TUBE

RADIATION PARTIALLY PRE-
IONIZES GAS GIVING DEPEND-
ABLE FIRING CHARACTERISTICS

USAEC-10-269A

Luminescence

AN

INDUSTRIAL USE OF RADIOISOTOPES

RADIOISOTOPE
ACTIVATED MARKERS

ONE MECHANISM

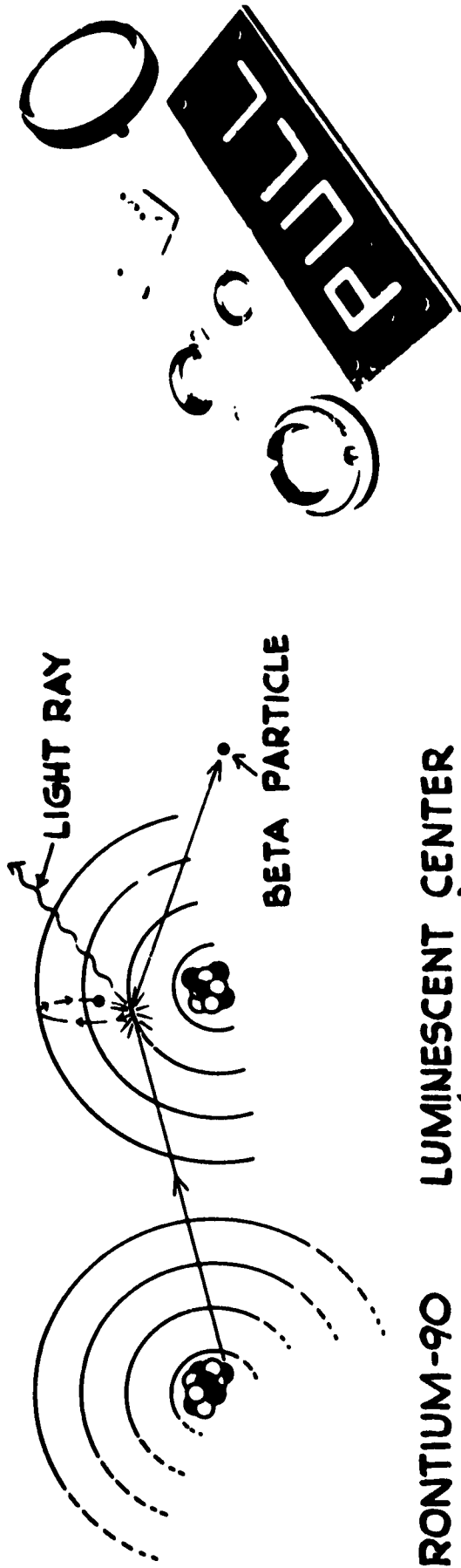

STRONTIUM-90 LUMINESCENT CENTER
(ZnS: Cd)

BETA SOURCES CAUSE LESS PHOSPHOR DETERIORATION THAN ALPHA — HAVE LONGER USEFUL LIFE AND LOWER EXTERNAL RADIATION LEVEL — MULTIPLE COMBINATIONS ARE POSSIBLE.

USAEC-10-270A

Cold Sterilization

AN

INDUSTRIAL USE OF RADIOISOTOPES

**EFFECT OF RADIATION
ON MICROORGANISMS
(ASPERGILLUS NIGER)**

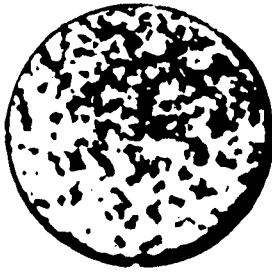

**NO RADIATION
(MOLD COUNT = 45,000,000)**

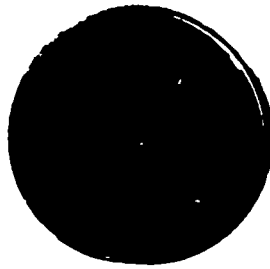

**260,000 REP
(MOLD COUNT = 0)**

**ATOMIC RADIATION HAS BEEN USED TO PRESERVE
DRUGS - FOODS - KILL INSECT LARVAE IN PACKAGED
PRODUCTS - CONTROL REPRODUCTION OF LIVESTOCK PESTS.**

STERILIZATION UNIT

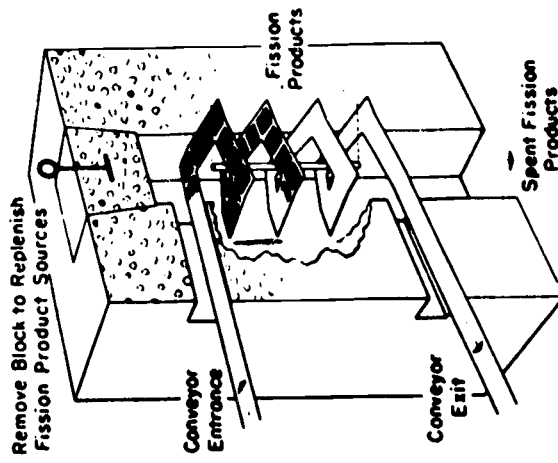

Field Sterilization

AN

USE OF RADIOISOTOPES

DIATION
NISMS
(NIGER)

STERILIZATION UNIT

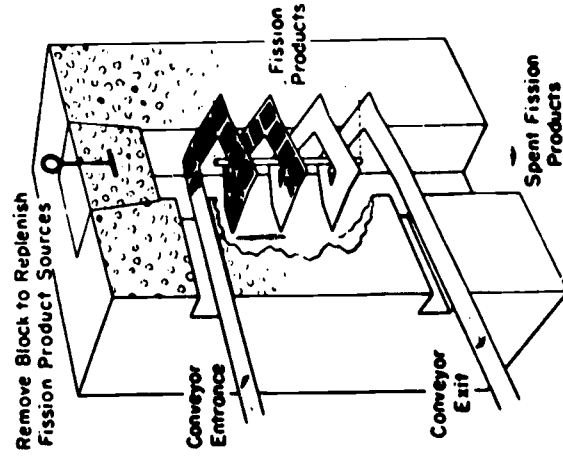

REP
(0)

ON HAS BEEN USED TO PRESERVE
- KILL INSECT LARVAE IN PACKAGED
ROL REPRODUCTION OF LIVESTOCK PESTS.

USABC-10-271A

Density and Moisture in Soil

AN INDUSTRIAL USE OF RADIOISOTOPES
IN ROAD BUILDING

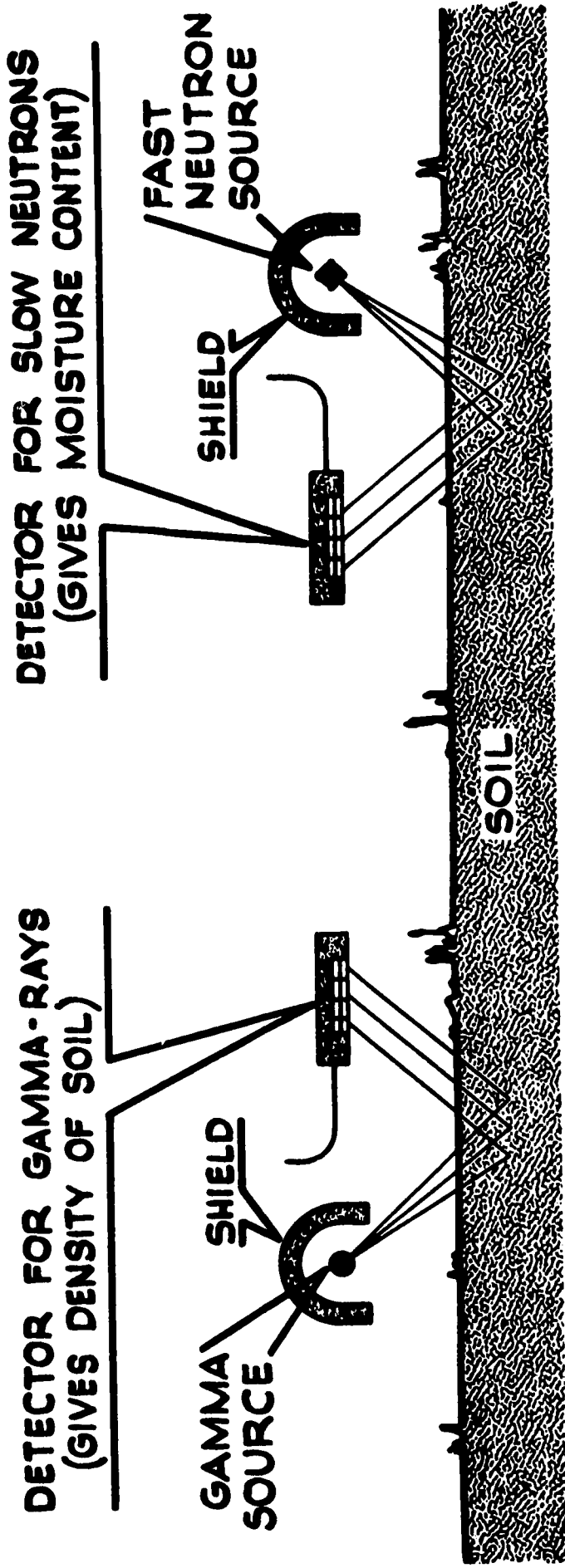

- 1- DATA OBTAINED WITHOUT MOVING SOIL
- 2- GAMMA-RAY DETECTOR MEASURES DENSITY
- 3- SLOW NEUTRON DETECTOR SHOWS MOISTURE

USACC-ID-296A

Measuring Efficiency of Separation USING RADIOACTIVE TRACER

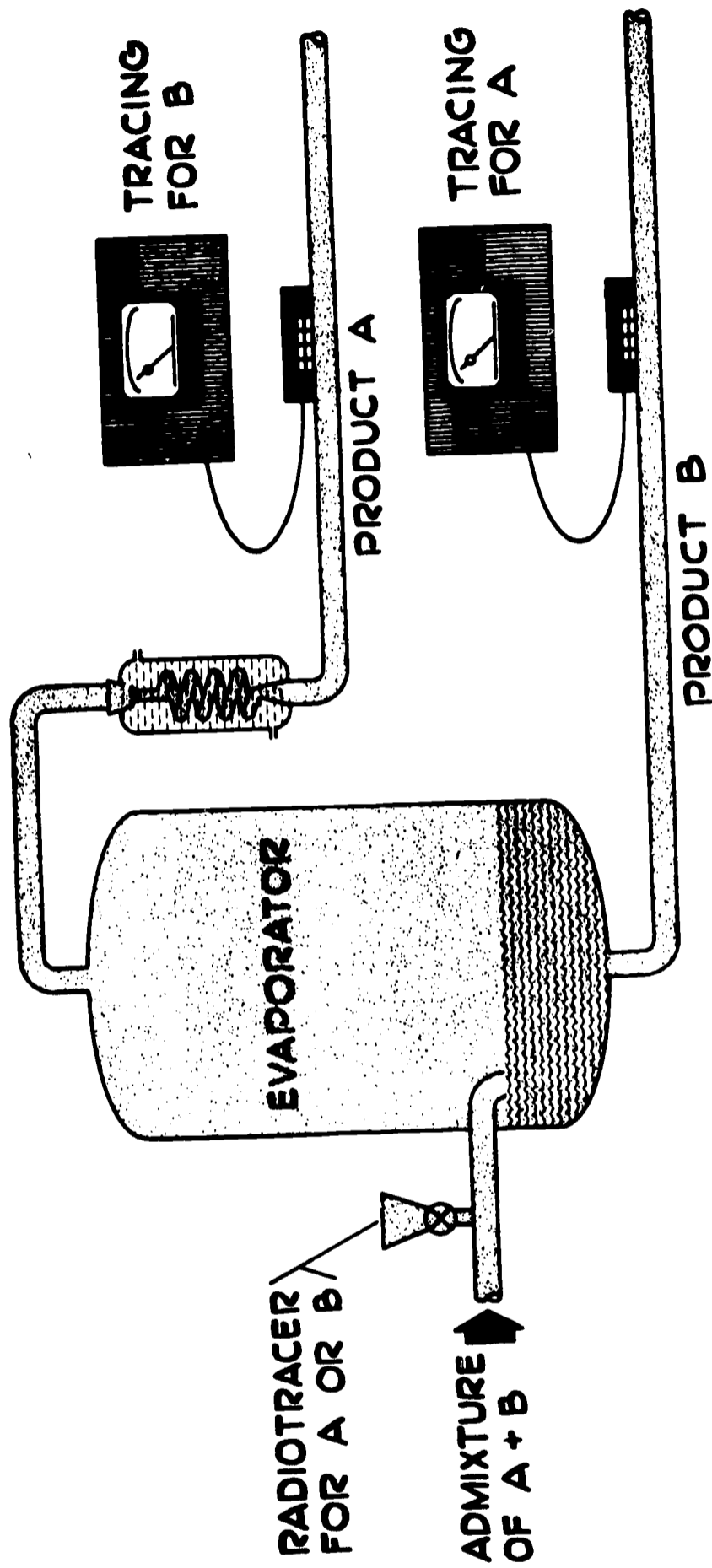

QUANTITATIVE MEASUREMENTS WHEN CALIBRATED
WITH STANDARD SAMPLES.

USAEC-ID-337A

Detection of Interfaces

PIPE - LINE FLOW (DENSITY GAGE)

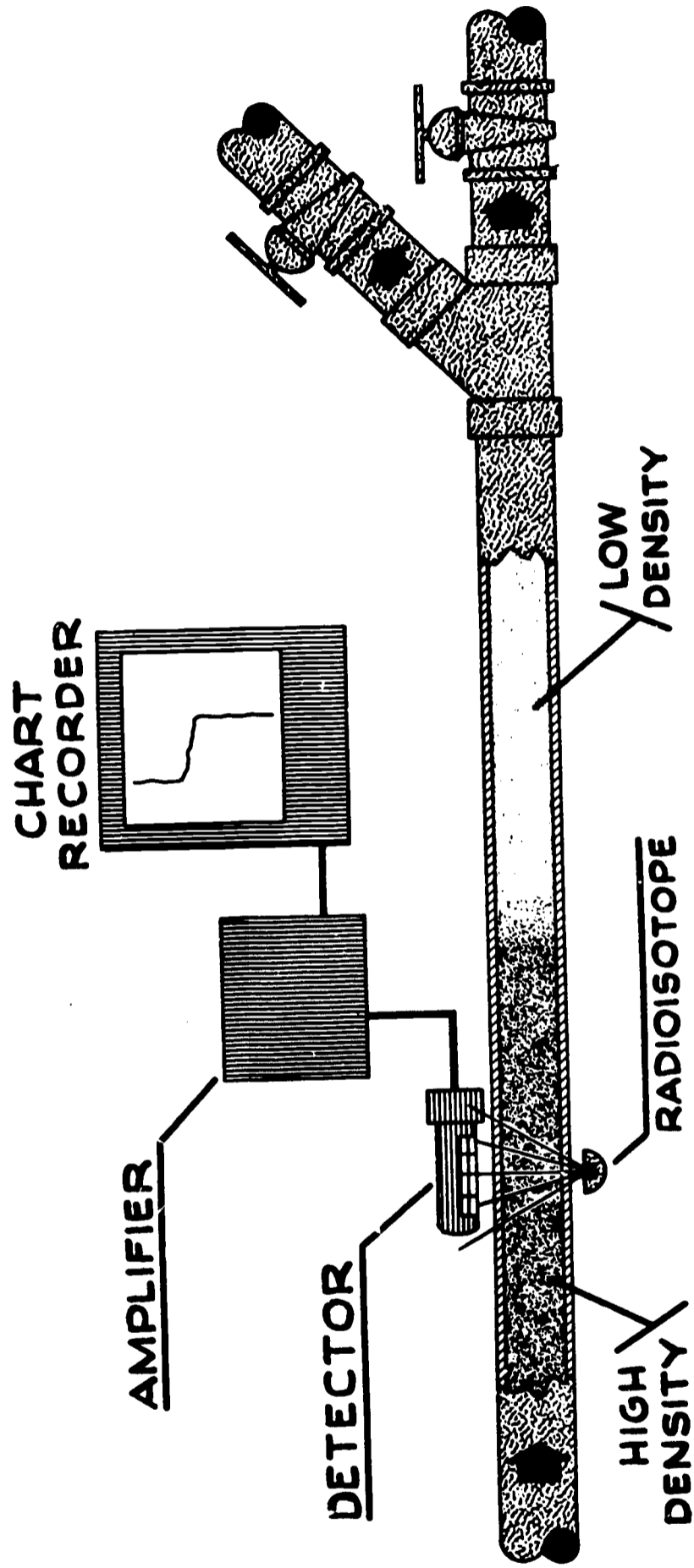

- PERMITS SEPARATION OF LIQUIDS WITH MINIMUM OF LOSS
- METHOD QUICK AND REQUIRES NO SAMPLING

USAEC-ID-307A

Isotope Marks Leak Location

IN PRESSURE TESTING METHOD

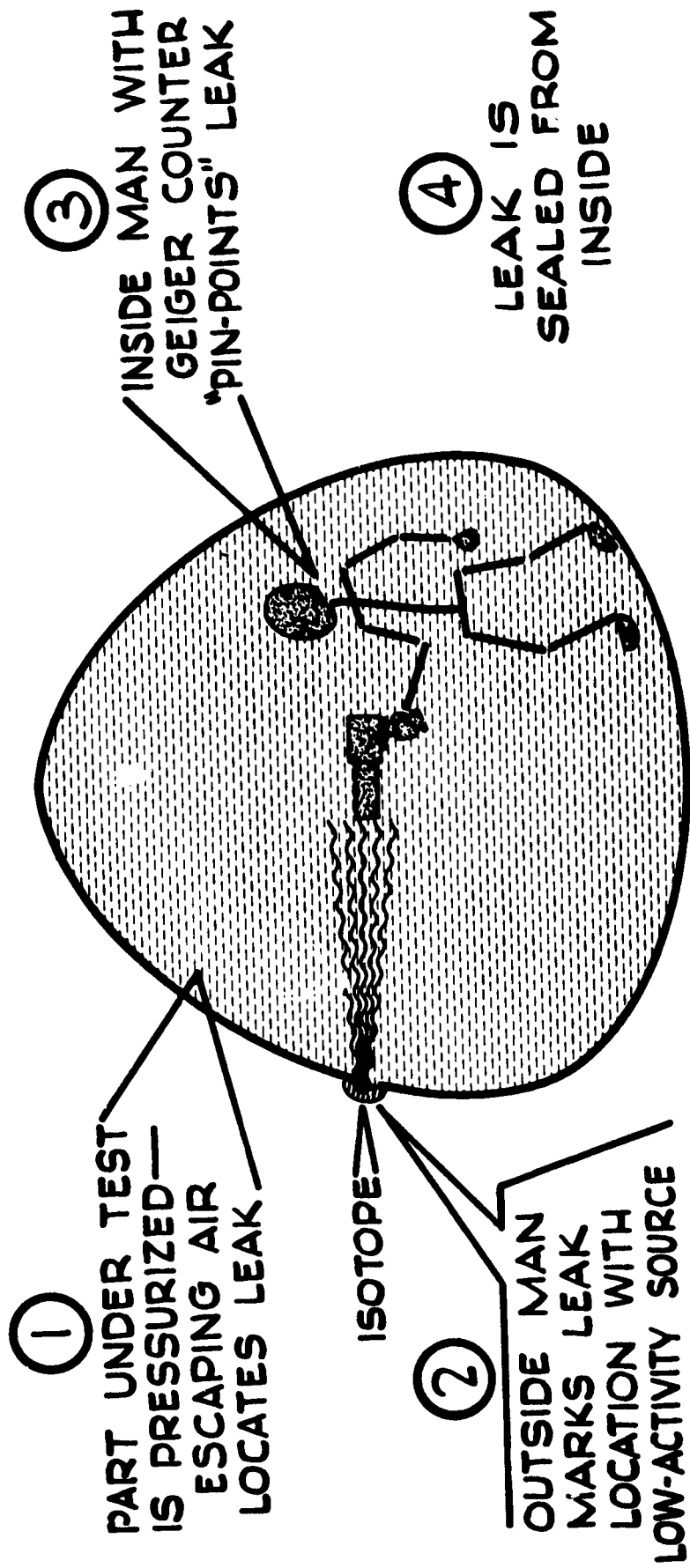

...NEW SYSTEM SAVES 25% TIME AND COST.
...OLD SYSTEM REQUIRED TWO-MAN COMMUNICATIONS VIA
HEAD-SET TO 'PIN-POINT' LEAK.

USAEC-ID-309A

Measuring Flow Rate by Integrated Count

USING

RADIOISOTOPE TRACER

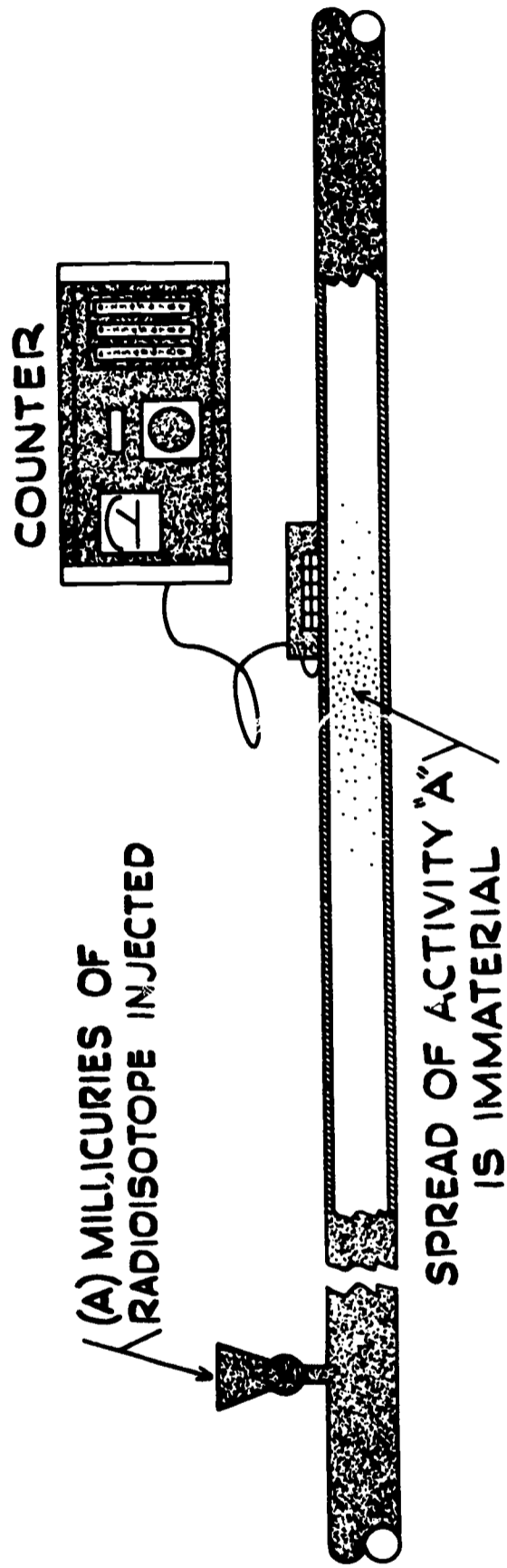

COUNTING RATE DEPENDS ON CONCENTRATION

$\text{COUNTS/SEC} = \text{CONSTANT} \times \text{MC/GALLON}$

TOTAL COUNT DEPENDS ON TIME OF PASSAGE

$\text{COUNTS} = \text{CONSTANT} \times \text{SEC} \times \text{MC/GALLON}$

THEREFORE, FLOW RATE IS GIVEN BY TOTAL COUNT

$\text{GAL/SEC} = \text{CONSTANT} \times "A" \times 1/\text{COUNTS}$

USAEC-ID-335A

Determining Flow Rate by Peak Timing

USING RADIOACTIVE TRACER

RADIOACTIVE TRACER

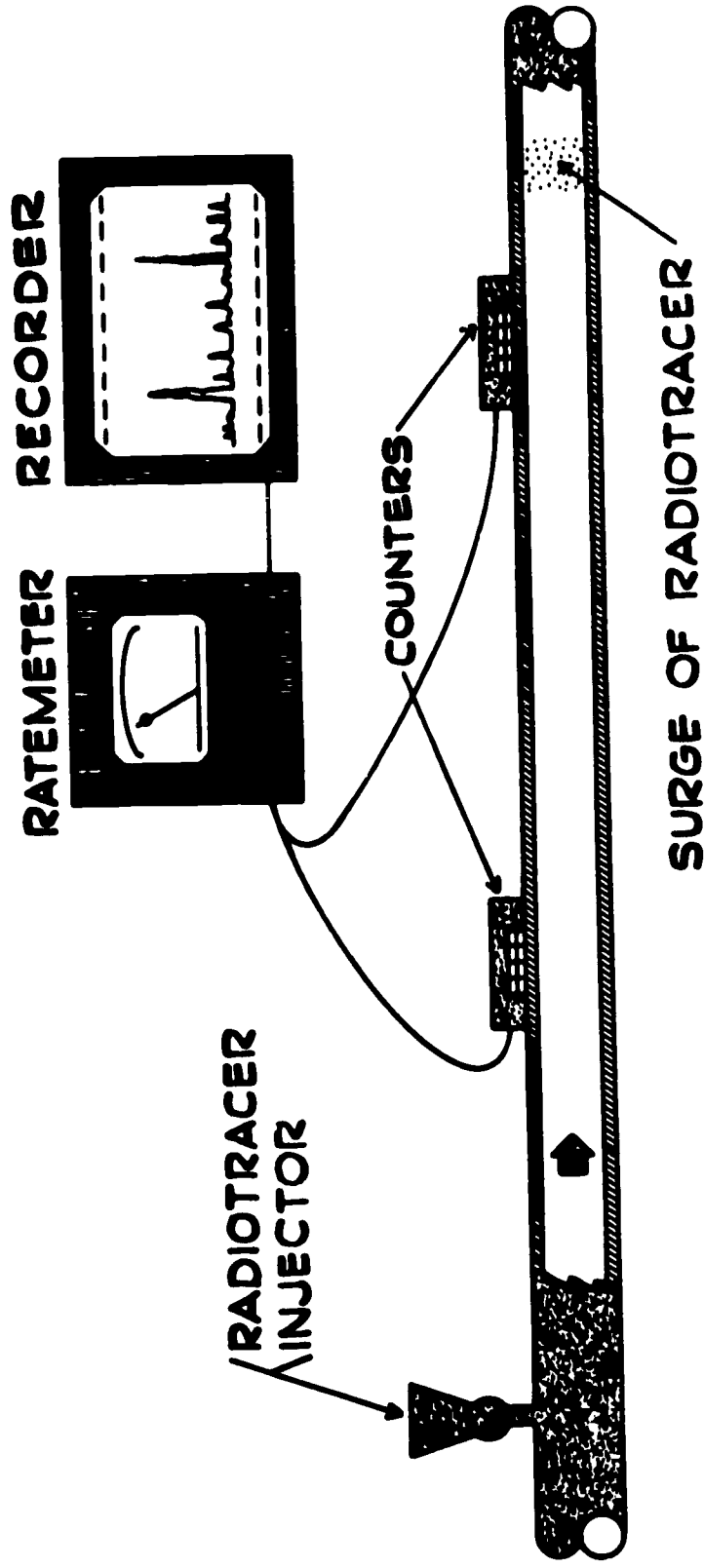

.. PIPE CAPACITY BETWEEN COUNTERS IS V GALLONS

.. TIME BETWEEN COUNTER RESPONSES IS T MINUTES

$$\text{FLOW RATE} = V/T$$

USAEC-ID-336A

RADIOACTIVE COBALT - Co 60

FOR RADIOGRAPHY TESTING

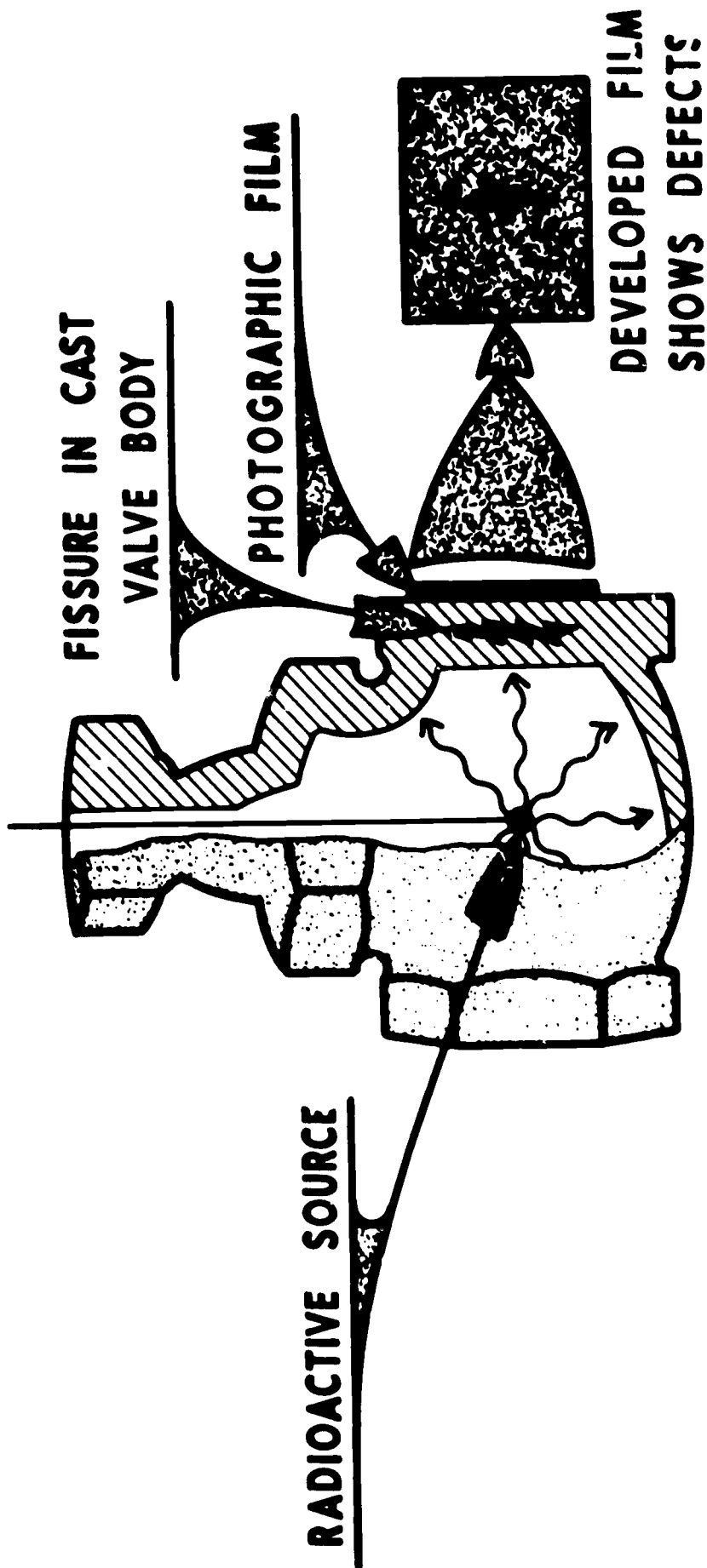

ADVANTAGES:

- 1 - VERSATILE AND RELIABLE INSPECTION**
- 2 - INSPECTION MADE WITHOUT DISMANTLING**
- 3 - SOURCES OF DESIRED SHAPE AND SIZE**
- 4 - VERY HIGH ACTIVITY SOURCES AVAILABLE AT LOW COST**

USAEC-ID-63A

Activation of Chemical Reactions

AN INDUSTRIAL USE OF RADIOISOTOPES

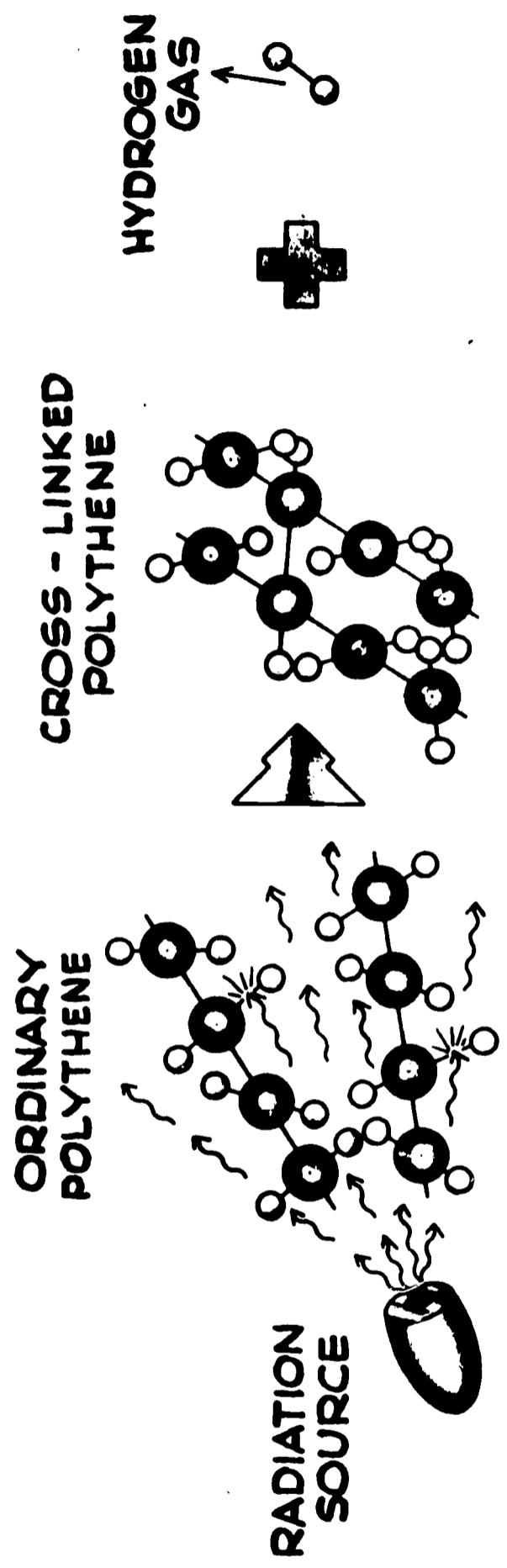

ADVANTAGES:

- 1- CROSS-LINKED POLYTHENE IS:
 - A- MORE HEAT RESISTANT
 - B- MORE ELASTIC
 - C- LESS SOLUBLE
- 2- REQUIRES NO HEAT OR ADDITION OF FOREIGN ATOMS
- 3- DEGREE OF CROSS-LINKING CAN BE CAREFULLY CONTROLLED
- 4- MANY NEW PLASTICS CAN BE SYNTHESIZED

USAEC-10-267A



Single copies of this booklet and similar educational materials may be obtained free by writing:

U. S. Atomic Energy Commission
Division of Technical Information Extension
Educational Materials Section
P. O. Box 62
Oak Ridge, Tennessee 37831

Requests should indicate the specific topic of interest as well as the educational level and the proposed use of the material desired.